

RR BOX 93

per miscelatore vasca-doccia
con deviatore 3 uscite e 3 posizioni
o deviatore 3 uscite e 7 posizioni
for bath-shower mixer
with diverter 3 ways and 3 positions
or diverter 3 ways and 7 positions

Rispetto al tradizionale miscelatore incasso con deviatore, la box incasso Remer presenta diverse caratteristiche aggiuntive che ne fanno un articolo studiato appositamente per le esigenze di cantiere.

Versatile, pratica, funzionale, veloce e sicura nell'installazione, la box da incasso Remer è assolutamente la scelta migliore per dotare il cantiere di una parte murata che nasce per poter poi essere finalizzata in ogni incasso doccia con deviatore Remer, quindi può essere abbinata coerentemente con le scelte che l'acquirente finale si riserverà di fare in uno stadio più avanzato dei lavori.

La box è stata appositamente studiata per alloggiare tutte le nostre serie di miscelatori con:

- A) cartuccia termostatica
- B) cartuccia da 40 mm
- C) cartuccia da 35 mm
- +
- D) DEVIATORE A 3 VIE

Quindi, senza più preoccuparsi in anticipo su quale serie e funzionalità possa essere di maggior gradimento ai clienti finali dei vostri cantieri, con la box Remer potrete rendere un servizio migliorativo dando possibilità alla vostra clientela di scegliere in un secondo momento tra le tante varianti di rubinetteria proposte a catalogo Remer.

Compared with the traditional built-in mixer with diverter, the Remer built-in box has several additional features that make it an item specifically designed for the construction sites needs.

Versatile, practical, functional, quick and safe to install, the Remer built-in box is absolutely the best choice to equip the construction site with a walled part born in order to be finalized in every Remer built-in bath-shower mixer and then be consistently matched with the choices that the final purchaser will take in a more advanced stage of the works.

The box has been specially designed to set all our mixers series with:

- A) thermostatic cartridge
- B) 40 mm cartridge
- C) 35 mm cartridge
- +
- D) 3 POSITIONS DIVERTER

With the Remer box you can offer an improving service, giving to your customers the chance to choose later between many variants of the proposed Remer catalogue taps, no more worrying in advance about which series and features can be of greatest appeal to final customers of your construction sites.

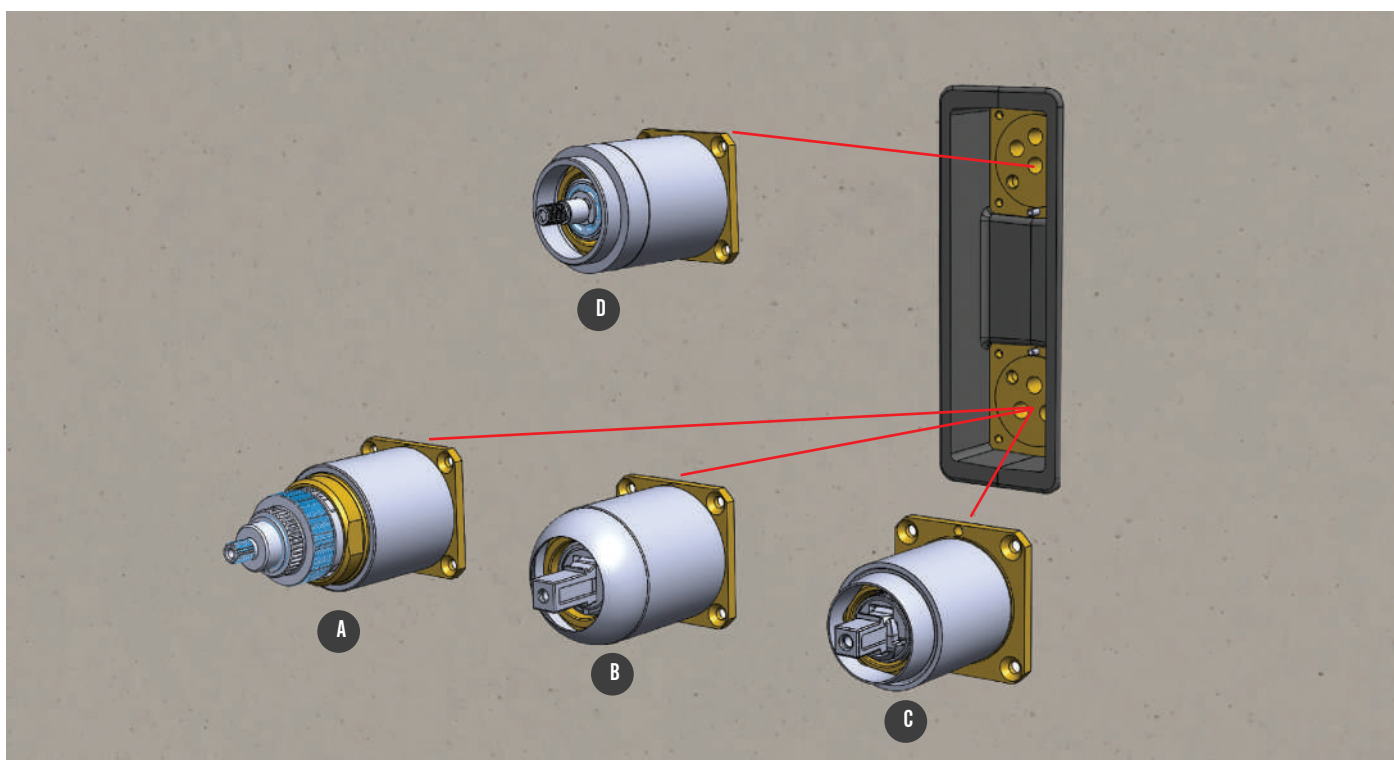

A Cartuccia Termostatica.

B Cartuccia Ø 40.

C Cartuccia Ø 35.



D Deviatore 3 vie

A Thermostatic Cartridge.

B Ø 40 Cartridge.

C Ø 35 Cartridge.



D Deviatore 3 vie

Con la box incasso potranno quindi essere installate le combinazioni:

- bocca per vasca - saliscendi doccia - soffione doccia
- saliscendi doccia - soffione doccia - soffione doccia cascata
- bocca per vasca - soffione doccia - soffione doccia cascata
- soffione - getti doccia - saliscendi doccia
- saliscendi doccia - getti doccia - soffione doccia cascata
- bocca vasca - getti doccia - saliscendi doccia

finalizzate come il cliente richiederà a seguito della scelta estetico funzionale dell'ambiente bagno nel suo insieme, quindi in abbinamento ai miscelatori lavabo bidet etc.

Remer box incasso e tutti i suoi componenti sono interamente prodotti in Italia utilizzando i migliori materiali e tecnologie produttive high-tech.

La materia prima utilizzata per il contenitore della box Remer, ad alta densità, è stata appositamente selezionata per essere pratica al taglio, durevole nel tempo, protettiva, resistente e molto insonorizzante.

With the built-in box, the following combinations can then be installed :

- bathtub spout - shower sliding rail - shower head
- shower sliding rail - shower head - waterfall showerhead function
- bathtub spout - shower head - waterfall showerhead function
- shower head - shower jets - sliding rail
- shower jets - shower head - waterfall showerhead function
- bathtub spout - shower jets - sliding rail

finalized as the customer will require, following the aesthetical - functional choice of the bathroom as a whole, thus matching with basin mixers, bidet mixers etc Remer built-in box and all of its components are entirely produced in Italy using the finest materials and high-tech production technologies.

The raw material used for Remer built-in box cover, in high density, has been specially selected to be practical to cutting, long-lasting, protective and safe and give further noise insulation.

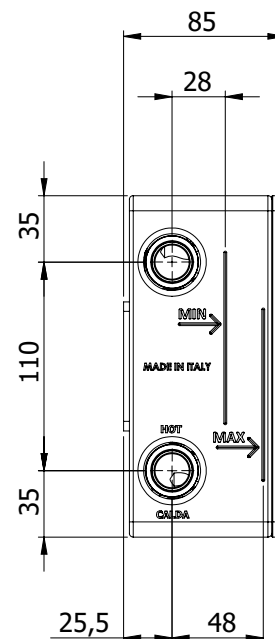
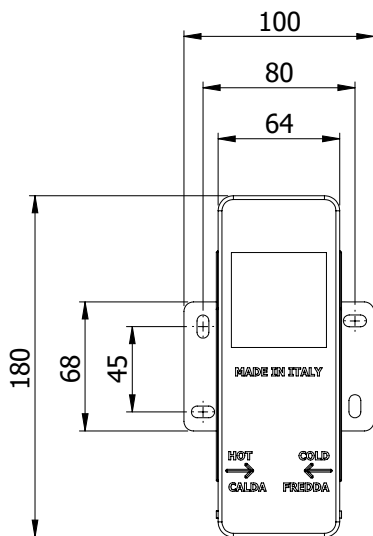
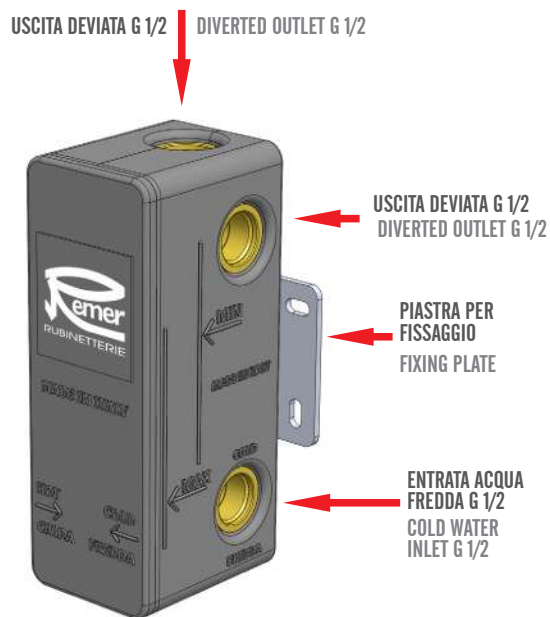

Cod. RR BOX 93



Una volta installata la vostra REMER BOX

Potrete nel tempo scegliere il kit piu' adatto alle vostre esigenze e ai vostri gusti tra i seguenti kit doccia con deviatore, corrispondenti ciascuno a linee di rubinetteria Remer delle quali trovate maggiori informazioni e documentazione completa sul nostro Catalogo Generale e su www.remer.eu

Once installed your REMER BOX

You will have the chance, in time, to finish your set by choosing the line and functionality you prefer, within the full choice below, each one corresponding to a Remer mixers line of which you will find full details and information on our General Catalogue and on www.remer.eu

INCASSI CON RR BOX 93 - BUILT IN WITH RR BOX 93

VANITY	WINNER	DREAM	INFINITY	ATMOS	CLASS LINE	X STYLE
 V 93 KB	 W 93 KB	 D 93 KB	 I 93 KB	 A 93 KB	 L 93 KB	 X 93 KB
 V 93 7 KB	 W 93 7 KB	 D 93 7 KB	 I 93 7 KB	 A 93 7 KB	 L 93 7 KB	 X 93 7 KB
MINIMAL	FLASH	QUBIKA	SQ3	JAZZ	MINIMAL THERMO	QUBIKA THERMO
 N 93 KB	 Z 93 KB	 Q 93 KB	 S 93 3 KB	 J 93 KB	 NT 93 KB	 QT 93 KB
 N 93 7 KB	 Z 93 7 KB	 Q 93 7 KB	 S 93 7 3 KB	 J 93 7 KB	 NT 93 7 KB	 QT 93 7 KB

INSTALLAZIONE SEMPLICE E VELOCE QUICK AND EASY INSTALLATION

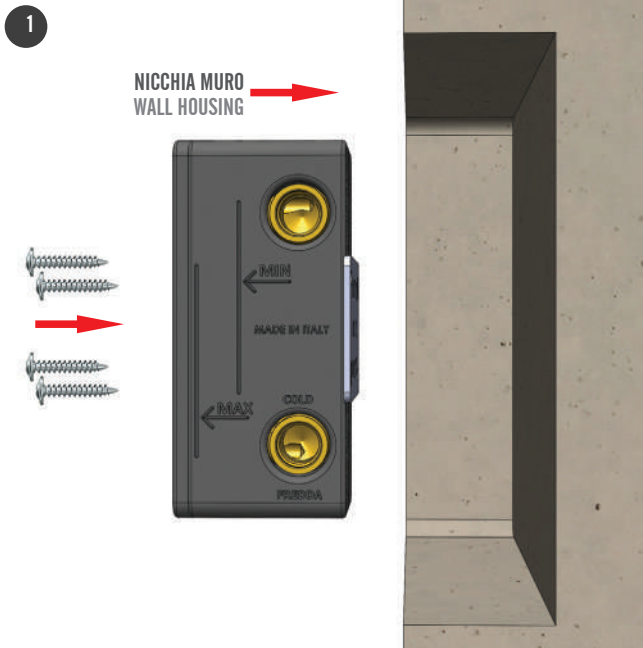

Creare una nicchia nel muro in modo tale che, una volta fissato il box incasso al suo interno, il bordo del muro finito e piastrellato sia compreso tra le due linee in rilievo (min. & max.) stampate sul box incasso.

Create a housing in the wall so that, once the built-in box is secured inside it, the edge of the finished and tiled wall will be between the two lines in relief (min. & max.) printed on the box itself.

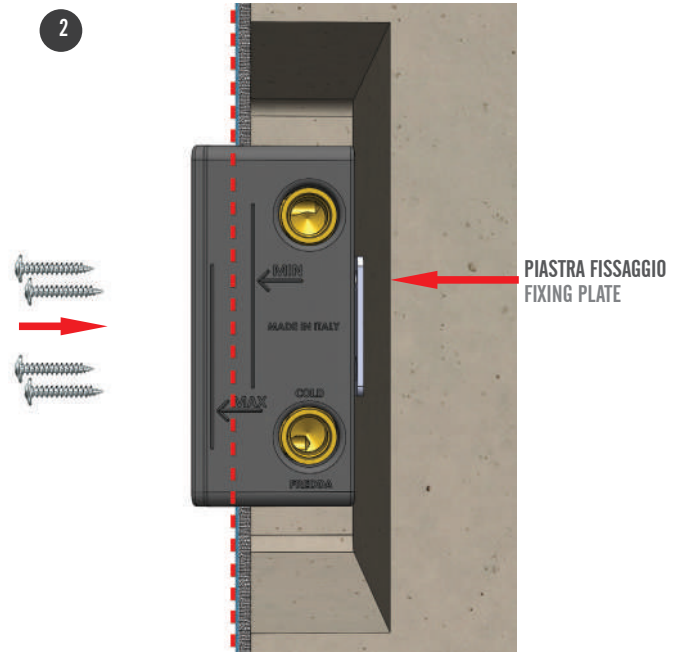

Fissare il box incasso con 4 viti al muro tramite piastra per fissaggio.

N.B.: la Box può essere murata oppure installata su legno o cartongesso tramite le apposite viti di fissaggio.

Secure the built-in box to the wall with 4 screws, using a fixing plate.

Note: the Box can be cemented to the wall or installed on wood walls through the four screws.

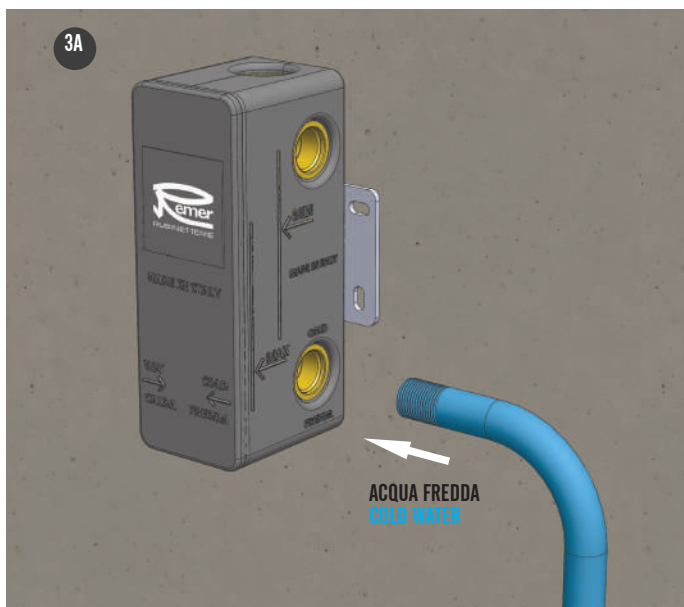

Collegare le tubazioni acqua fredda (3A) e calda (3B) seguendo le indicazioni stampate sul box incasso.

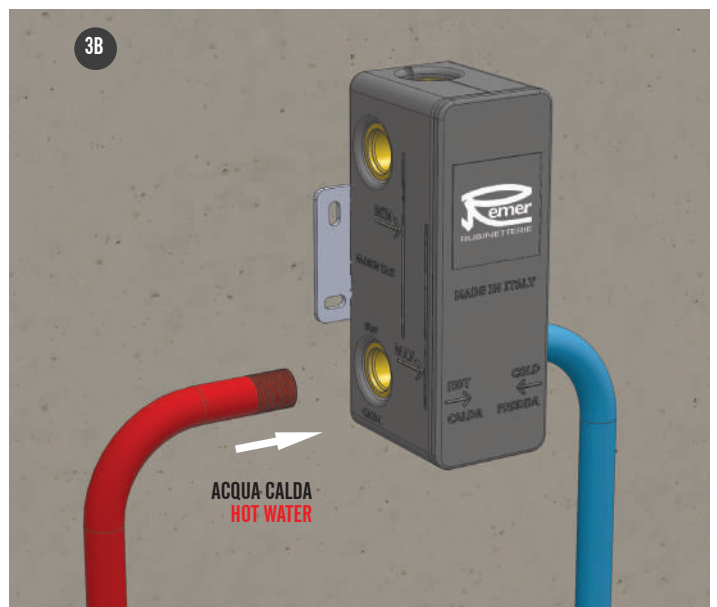

Connect the cold (3A) and hot (3B) water pipes following the instructions printed on the built-in box.

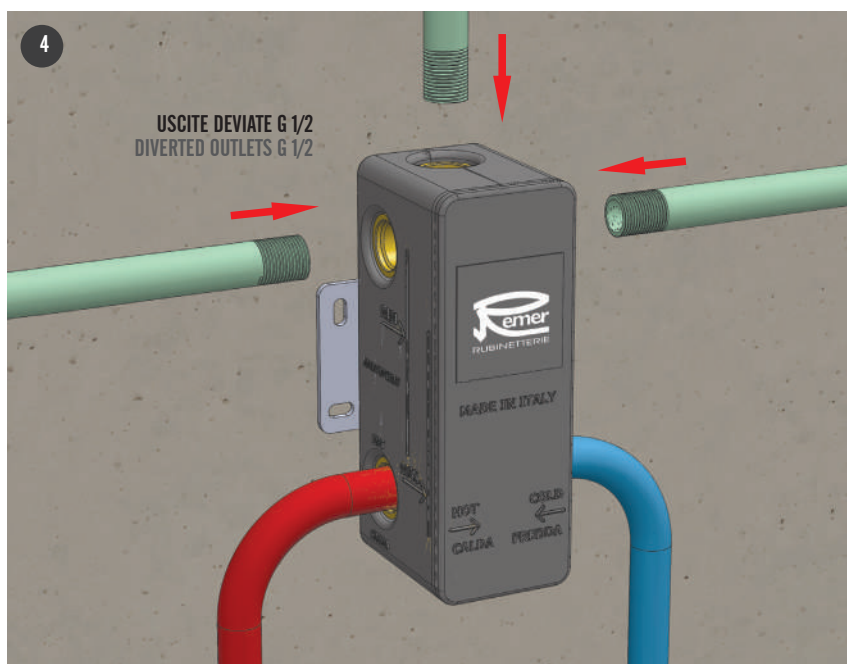

Collegare le 3 tubazioni delle uscite deviate da G 1/2 (in verde nel disegno).
Connect the 3 G1/2 outlets output upper pipe(green in the drawing).

A QUESTO PUNTO POTRETE EFFETTUARE LA PROVA IMPIANTO.
AT THIS STAGE YOU CAN TEST THE SYSTEM WITH WATER.

PROVA IMPIANTO: FINE INSTALLAZIONE DA CANTIERE PLANT TEST: CONSTRUCTION SITE INSTALLATION PHASE FINISHED

A SEGUITO DI TEST POSITIVI DI PROVA IMPIANTO PROCEDERE ALLA FINITURA DELLE PARETI.

FOLLOWING POSITIVE TESTS ON THE PLANT PROCEED TO THE FINISHING OF THE WALLS.

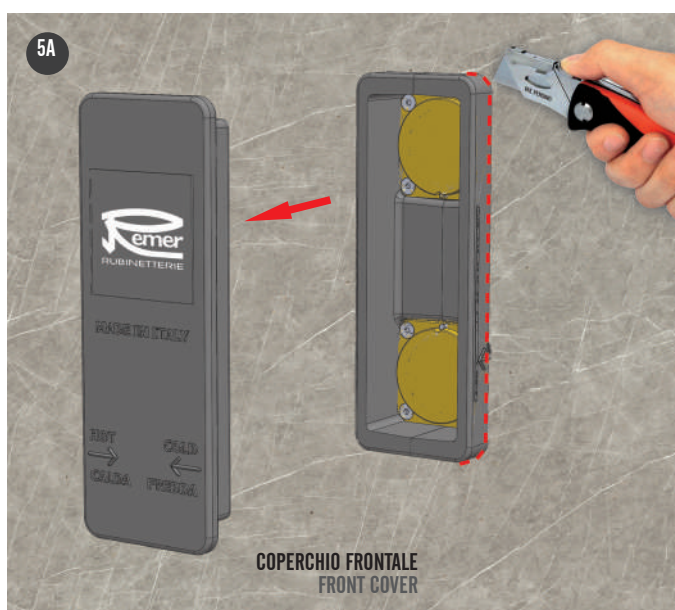

Dopo aver tolto il coperchio frontale del box incasso asportare con un taglierino la parte in eccesso di coperchio che fuoriesce rispetto al filo del muro.



After removing the built-in box front cover, remove the cover exceeding the edge of the wall with a cutter.

SCEGLIERE IL PRODOTTO IDONEO ALLE PROPRIE ESIGENZE CONSULTANDO LA TABELLA A PAG 3
CHOOSE THE PRODUCT MORE SUITABLE FOR YOUR INSTALLATION BY CONSULTING THE TABLE AT PAGE 3

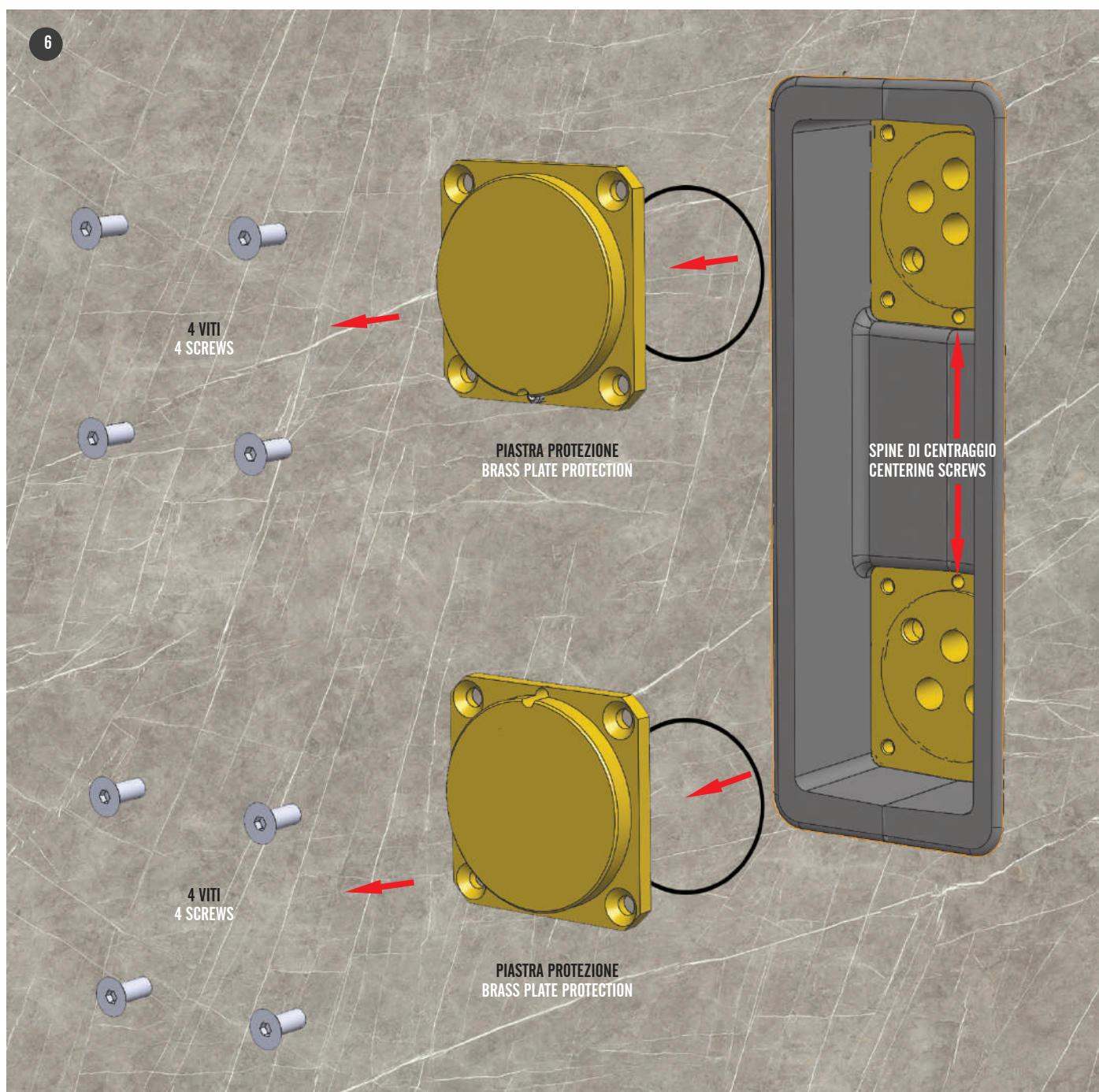

Svitare all'interno del box i 2 tappi in ottone.
Svitare le 8 viti, sfilare le piastre di protezione in ottone e i 2 oring.
NON UTILIZZARE QUESTI 2 ORING PER L'INSTALLAZIONE DELLE PARTI ESTERNE.

*Unscrew the 2 brass caps inside the box.
Unscrew the 8 screws, remove the brass protection plates and 2 oring.
DO NOT USE THESE 2 ORINGS FOR INSTALLATION OF THE EXTERNAL PARTS.*

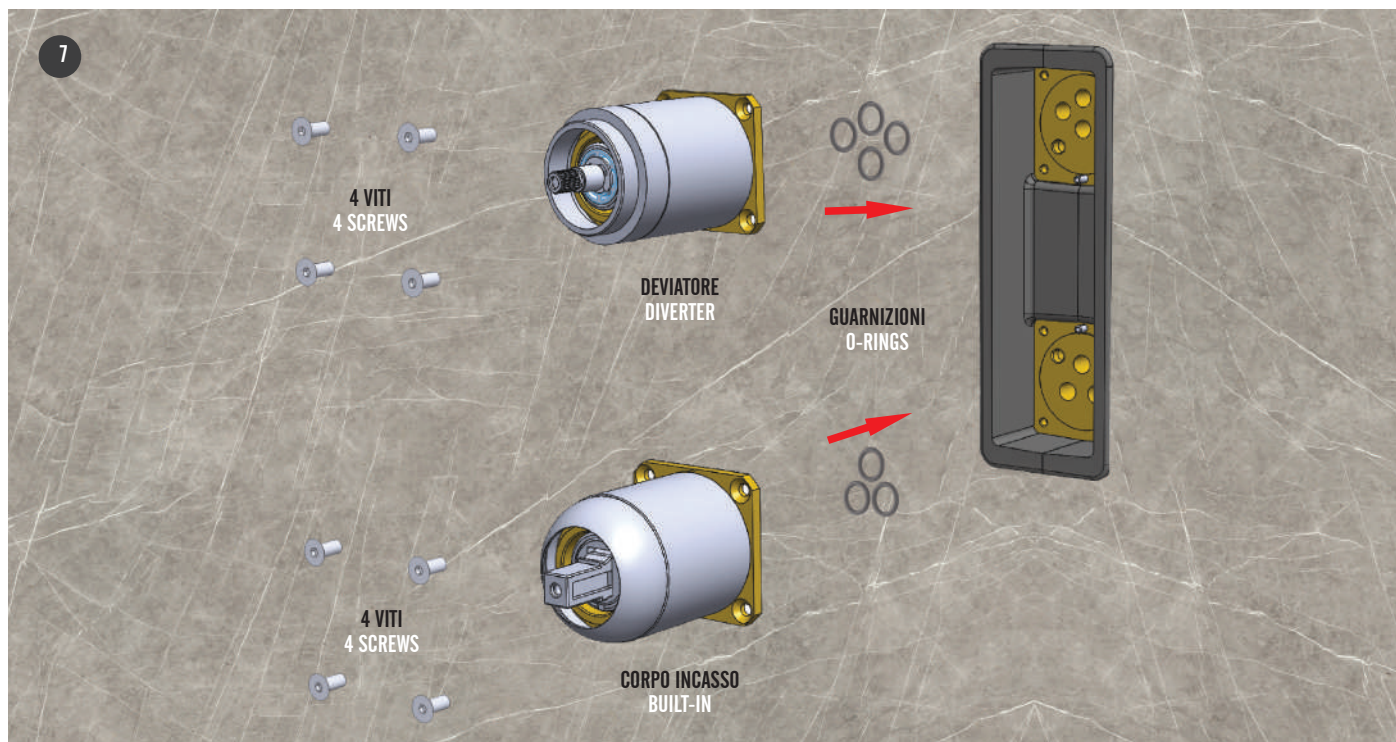

Montare i 2 incassi cromati all'interno del box aiutandosi per il corretto assemblaggio del miscelatore con la spina di centraggio in dotazione. Durante questa fase assicurarsi di aver inserito le piccole guarnizioni indispensabili per la tenuta ermetica nei passaggi acqua.

Install the 2 chrome plated built-in bodies inside the box and assembly the product with the help of the provided centering pin. During this phase, make sure the 3 small seal gaskets, essential to the water-seal, have been inserted.

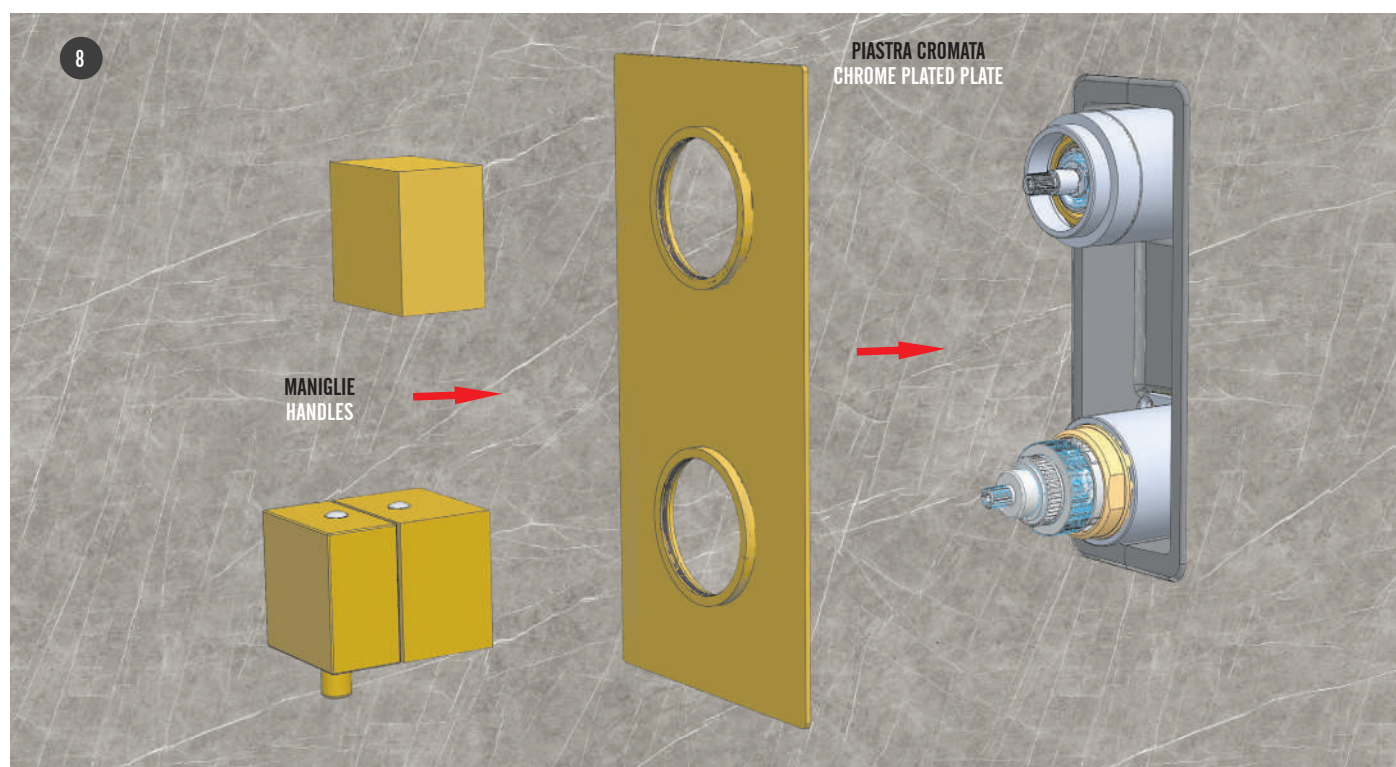

Montare la piastra cromata e le maniglie per completare l'installazione.

Install the chrome plated plate and the handles in order to complete the installation.

ESEMPI DI SOLUZIONI FINALI EXAMPLES OF FINAL SOLUTIONS

9

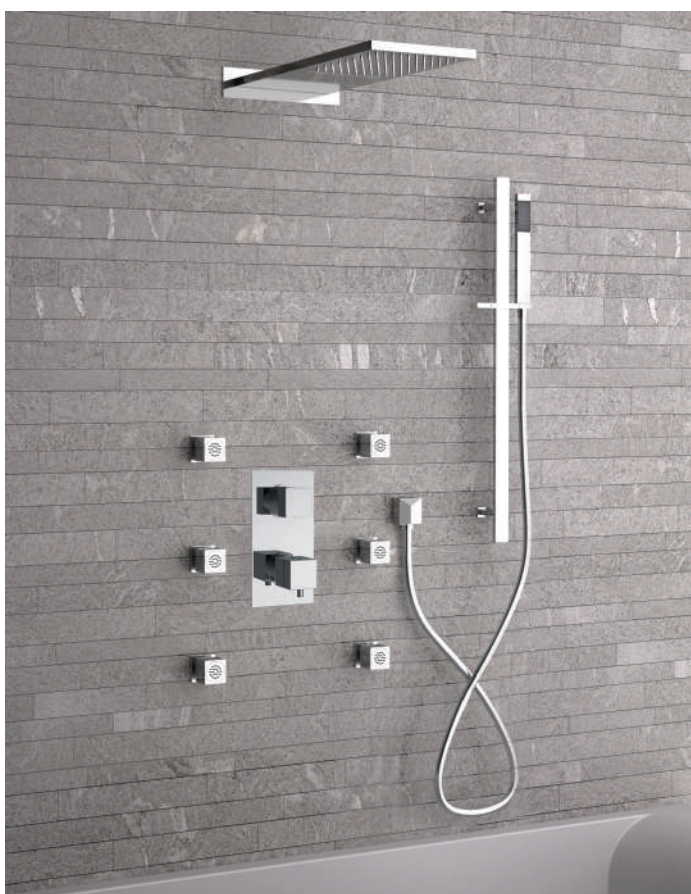

REMER
RUBINETTERIE

Remer Rubinetterie S.p.A.
Via Leonardo da Vinci, 83
20062 Cassano d'Adda (MI) Italy
Tel. +39 0363 364 211
E-Mail: info@remer.eu
www.remer.eu

Ufficio Commerciale Italia:
Tel. 0363 364 333
Fax 0363 63 575

Export Commercial Department:
Tel. +39 0363 364 364
Fax +39 0363 364 300