

REMER

YOUR CONTEMPORARY STYLE



REMER
RUBINETTERIE

2025
COLLECTION

YOUR CONTEMPORARY STYLE



LISTINO PREZZI
PRICE LIST
2025



BAGNO BATHROOM

◇◇◇◇◇◇◇◇◇◇◇◇◇◇◇◇◇◇◇◇ DESIGN

24	ATELIER
36	CHRONO
52	CELEBRITY
68	ELEMENT
82	Q DESIGN
98	X-STYLE

◇◇◇◇◇◇◇◇◇◇◇◇◇◇◇◇◇◇◇◇ CONTEMPORANEO

120	METRICA
134	ENERGY / ECO
156	SLASH / DOT
176	ABSOLUTE
194	INFINITY
212	VANITY
224	DREAM
236	CLASS LINE
254	WINNER / ECO
278	LIBERTY



WELLNESS

	BOX INCASSO <i>BUILT-IN BOX</i>
294	TERMOSTATICI A PULSANTE <i>PUSH-BUTTON TERM.</i>
316	TERMOSTATICI <i>THERMOSTATICS</i>
322	COLONNE DOCCIA <i>SHOWER COLUMNS</i>
342	KIT WELLNESS <i>WELLNESS KIT</i>
360	CROMOTERAPIA <i>COLORTHERAPY</i>
376	SOFFIONI <i>SHOWER HEADS</i>
388	BOCCHIE <i>SPOUTS</i>
406	PANNELLI DOCCIA <i>SHOWER PANELS</i>
412	SALISCENDI <i>SLIDING RAILS</i>
416	DOCCHETTE <i>HAND SHOWERS</i>
424	BORDO VASCA <i>DECK BATH MIXERS</i>
440	



INOX

446	X-STYLE INOX
	WELLNESS INOX <i>INOX WELLNESS</i>
452	ACCESSORI INOX <i>INOX ACCESSORIES</i>
464	PLACCHE WC <i>WC PLATES</i>
467	OUTDOOR / INDOOR
468	CUCINA INOX <i>INOX KITCHEN</i>
472	

REMER INDEX



ACCESSORI ACCESSORIES

542 SHUT-OFF

PLACCHE WC

556 *TOILET PLATES*

LAVABO

558 *WASHBASIN*

560 LOUNGE

562 FLAT

564 GUEST

568 SUITE

570 EPOCA

ACCESSORI

572 *ACCESSORIES*

IDROSCOPINI

576 *HYDRO-BRUSH*

COMPLEMENTI

578 *COMPLEMENTS ITEM*

RICAMBI

592 *SPARE PARTS*



CUCINA KITCHEN

480 ELEGANT KITCHEN

CUCINA ESTRAIBILE

486 *PULL-OUT*

TUTTO CUCINA

494 *ALL KITCHEN*

CUCINA COUNTRY

502 *COUNTRY KITCHEN*

ACQUA DEPURATA

504 *PURIFIED WATER*

512 TOUCH-ME



PUBLIC

518 SENSOR

526 SENSOR COLOR

530 TEMPOR

LEVA CLINICA

536 *LONG LEVER*

ATELIER

Atelier è una collezione che celebra il fascino retrò reinterpretato con accenti contemporanei. Forme sinuose, dettagli raffinati e finiture di lusso si combinano per un'eleganza intramontabile.

Atelier is a collection that celebrates vintage charm reinterpreted with contemporary accents.

Elegantly countoured shapes, refined details, and luxurious finishes combine for timeless elegance.



PAG. 24

HIGHLIGHTS

Metrica è una collezione di rubinetteria monocomando ideale per ambienti moderni e di carattere. Il design distintivo della leva di miscelazione dona stile e personalità, esaltando l'intera struttura.



Metrica is a collection of single-lever faucets, perfect for modern and characterful spaces. The distinctive design of the mixing lever adds style and personality, enhancing the entire structure

PAG. 120

METRICA



SLASH&DOT

PAG. 156

Le collezioni Slash e Dot nascono da una visione condivisa e sono accomunate da un design moderno che offre la scelta tra una leva cilindrica e una inclinata verso l'alto, garantendo funzionalità e ricercatezza in ogni ambiente.

The Slash and Dot collections originate from a shared vision and are united by a modern design, offering a choice between a cylindrical lever and one inclined upwards, ensuring functionality and refinement in any setting.



CHRONO

CHRONO è una collezione di miscelatori monocomando con un forte richiamo agli ingranaggi del tempo. La scelta di rubinetteria ideale per accompagnare uno stile di interni urbano e industriale.

CHRONO is a collection of single lever mixers with a strong reference to the gears of time. The perfect choice of faucets to match an industrial and urban interior style.

PAG. 36

ELEMENT

La collezione Element esprime un'eleganza sofisticata, definita da linee ricercate e da un'impugnatura dal design esclusivo, ergonomica e progettata per offrire comfort e stile senza compromessi.

The Element collection exudes sophisticated elegance, defined by refined lines and an exclusive handle design, both ergonomic and crafted to deliver unparalleled comfort and style.



PAG. 68



Celebrity è una collezione di miscelatori monocomando che fonde eleganza e raffinatezza. Il design senza tempo è impreziosito da intarsi pregiati, disponibili in tre modelli di maniglie, per un tocco di esclusività.

Celebrity is a collection of single-lever mixers that blends elegance and refinement. The timeless design is enhanced by exquisite inlays, available in three handle models, for a touch of exclusivity.

CELEBRITY

PAG. 52

LAVABO WASHBASIN

Con linee essenziali e materiali di alta qualità, questo lavabo è disponibile in varie finiture, perfetto per chi desidera uno stile elegante e raffinato in bagno.

With clean lines and high-quality materials, this sink is available in various finishes, perfect for those who desire both elegance and sophistication in the bathroom.



PAG. 558

WALLBOX

PAG. 296



Box incasso ingegneristiche, in svariate soluzioni, disposizione in orizzontale e verticale, da 1 a 5 vie.

Engineered built-in boxes, available in various solutions, designed for horizontal and vertical configurations, from 1 to 5 outlets.

PLACCHE WC TOILET PLATES

PAG. 556



Scopri la nostra gamma di placche WC, progettate per unire estetica e funzionalità. Offriamo due forme distintive: quadrata e tonda, e svariate finiture, per adattarsi perfettamente a qualsiasi bagno.

Discover our range of WC plates designed to combine aesthetics and functionality. We offer two distinctive shapes: square and round, available in various finishes to perfectly complement any bathroom.

TERMOSTATICI A PULSANTE PUSH-BUTTON THERMOSTATICS

THERMOBOX e THERMOSET, innovative soluzioni termostatiche ad incasso con singola box o box in linea per la gestione da una a cinque vie azionate da pulsanti ON/OFF.

THERMOBOX and THERMOSET, innovative built-in thermostatic solutions with single boxes or in-line boxes for managing one to five outlets operated by ON/OFF buttons.

PAG. 316



SOFFIONI SHOWER HEADS

PAG. 388

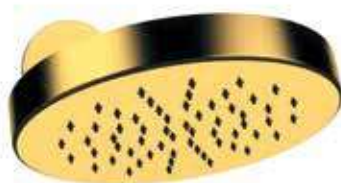

I lavabi con leva clinica sono progettati per garantire un'elevata igiene e facilità d'uso in contesti pubblici e professionali.

Clinical lever sinks are designed to ensure high hygiene standards and ease of use in public and professional settings.

LEVA CLINICA HYGIENIC LEVER MIXING

PAG. 536

OUTDOOR

Disponibili in diverse finiture e altezze, le nostre colonne doccia offrono soluzioni pratiche e raffinate per ogni spazio esterno.

Available in various finishes and heights, our outdoor shower columns provide practical and refined solutions for any outdoor space

PAG. 468



OPZIONI DI FINITURA

— FIN1 —



NO

NERO OPACO
MATT BLACK



Con flessibile | With flexible
332CN2G120NO



BO

BIANCO OPACO
MATT WHITE



Con flessibile | With flexible
332CN2G120BO



XV

VISUAL INOX
VISUAL STEEL



Con flessibile | With flexible
332CN2G120XV



BR

OIL BRONZE
OIL BRONZE



Con flessibile | With flexible
332CN2G120BR

— FIN2 —



CFP

CROMO NERO SPAZZOLATO
BRUSHED BLACK CHROME



Con flessibile | With flexible
332CN2G120CFP



BG

ORO SPAZZOLATO
BRUSHED GOLD



Con flessibile | With flexible
332CN2G120BG

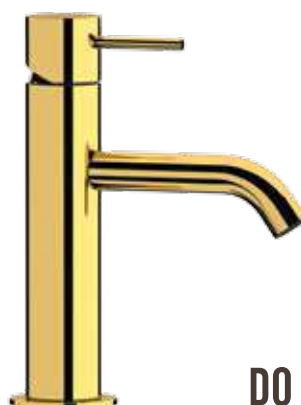

DO

ORO LUCIDO
SHINY GOLD



Con flessibile | With flexible
332CN2G120DO

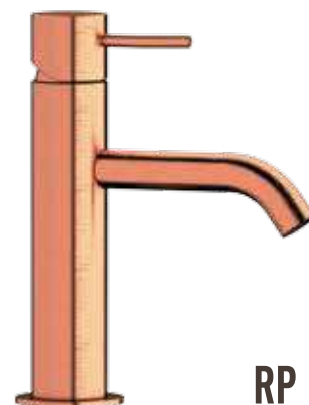

RP

RAME SPAZZOLATO
BRUSHED COPPER



Con flessibile | With flexible
332CN2G120RP

Crea uniche combinazioni di arredo personalizzando la rubinetteria con le opzioni di finitura. Un ventaglio di 8 colori che si inseriscono con facilità in ambienti sia classici che moderni per rispondere alle esigenze stilistiche dei progetti più creativi.

FINISHING OPTIONS

ATELIER	<table border="1"> <thead> <tr> <th colspan="3">FIN 1</th> <th colspan="4">FIN 2</th> </tr> </thead> <tbody> <tr> <td>NO</td> <td>BO</td> <td>XV</td> <td>CFP</td> <td>BG</td> <td>DO</td> <td>RP</td> </tr> </tbody> </table>	FIN 1			FIN 2				NO	BO	XV	CFP	BG	DO	RP	CHRONO	<table border="1"> <thead> <tr> <th colspan="3">FIN 1</th> <th colspan="4">FIN 2</th> </tr> </thead> <tbody> <tr> <td>NO</td> <td>BO</td> <td>XV</td> <td>CFP</td> <td>BG</td> <td>DO</td> <td>RP</td> </tr> </tbody> </table>	FIN 1			FIN 2				NO	BO	XV	CFP	BG	DO	RP		
FIN 1			FIN 2																														
NO	BO	XV	CFP	BG	DO	RP																											
FIN 1			FIN 2																														
NO	BO	XV	CFP	BG	DO	RP																											
CELEBRITY	<table border="1"> <thead> <tr> <th colspan="3">FIN 1</th> <th colspan="4">FIN 2</th> </tr> </thead> <tbody> <tr> <td>NO</td> <td>BO</td> <td>XV</td> <td>CFP</td> <td>BG</td> <td>DO</td> <td>RP</td> </tr> </tbody> </table>	FIN 1			FIN 2				NO	BO	XV	CFP	BG	DO	RP	ELEMENT	<table border="1"> <thead> <tr> <th colspan="3">FIN 1</th> <th colspan="4">FIN 2</th> </tr> </thead> <tbody> <tr> <td>NO</td> <td>BO</td> <td>XV</td> <td>CFP</td> <td>BG</td> <td>DO</td> <td>RP</td> </tr> </tbody> </table>	FIN 1			FIN 2				NO	BO	XV	CFP	BG	DO	RP		
FIN 1			FIN 2																														
NO	BO	XV	CFP	BG	DO	RP																											
FIN 1			FIN 2																														
NO	BO	XV	CFP	BG	DO	RP																											
Q DESIGN	<table border="1"> <thead> <tr> <th colspan="3">FIN 1</th> <th colspan="2">FIN 2</th> </tr> </thead> <tbody> <tr> <td>NO</td> <td>BO</td> <td>XV</td> <td>BG</td> <td>DO</td> </tr> </tbody> </table>	FIN 1			FIN 2		NO	BO	XV	BG	DO	X-STYLE	<table border="1"> <thead> <tr> <th colspan="3">FIN 1</th> <th colspan="4">FIN 2</th> </tr> </thead> <tbody> <tr> <td>NO</td> <td>BO</td> <td>XV</td> <td>BR</td> <td>CFP</td> <td>BG</td> <td>DO</td> <td>RP</td> </tr> </tbody> </table>	FIN 1			FIN 2				NO	BO	XV	BR	CFP	BG	DO	RP					
FIN 1			FIN 2																														
NO	BO	XV	BG	DO																													
FIN 1			FIN 2																														
NO	BO	XV	BR	CFP	BG	DO	RP																										
METRICA	<table border="1"> <thead> <tr> <th colspan="3">FIN 1</th> <th colspan="4">FIN 2</th> </tr> </thead> <tbody> <tr> <td>NO</td> <td>BO</td> <td>XV</td> <td>BR</td> <td>CFP</td> <td>BG</td> <td>DO</td> <td>RP</td> </tr> </tbody> </table>	FIN 1			FIN 2				NO	BO	XV	BR	CFP	BG	DO	RP	ENERGY	<table border="1"> <thead> <tr> <th colspan="3">FIN 1</th> <th colspan="4">FIN 2</th> </tr> </thead> <tbody> <tr> <td>NO</td> <td>BO</td> <td>XV</td> <td></td> <td></td> <td></td> <td></td> <td></td> </tr> </tbody> </table>	FIN 1			FIN 2				NO	BO	XV					
FIN 1			FIN 2																														
NO	BO	XV	BR	CFP	BG	DO	RP																										
FIN 1			FIN 2																														
NO	BO	XV																															
SLASH	<table border="1"> <thead> <tr> <th colspan="3">FIN 1</th> <th colspan="4">FIN 2</th> </tr> </thead> <tbody> <tr> <td>NO</td> <td>BO</td> <td>XV</td> <td></td> <td></td> <td></td> <td></td> <td></td> </tr> </tbody> </table>	FIN 1			FIN 2				NO	BO	XV						DOT	<table border="1"> <thead> <tr> <th colspan="3">FIN 1</th> <th colspan="4">FIN 2</th> </tr> </thead> <tbody> <tr> <td>NO</td> <td>BO</td> <td>XV</td> <td></td> <td></td> <td></td> <td></td> <td></td> </tr> </tbody> </table>	FIN 1			FIN 2				NO	BO	XV					
FIN 1			FIN 2																														
NO	BO	XV																															
FIN 1			FIN 2																														
NO	BO	XV																															
ABSOLUTE	<table border="1"> <thead> <tr> <th colspan="3">FIN 1</th> <th colspan="3">FIN 2</th> </tr> </thead> <tbody> <tr> <td>NO</td> <td>BO</td> <td>XV</td> <td>CFP</td> <td>BG</td> <td>DO</td> </tr> </tbody> </table>	FIN 1			FIN 2			NO	BO	XV	CFP	BG	DO	INFINITY	<table border="1"> <thead> <tr> <th colspan="3">FIN 1</th> <th colspan="2">FIN 2</th> </tr> </thead> <tbody> <tr> <td>NO</td> <td>BO</td> <td>XV</td> <td>BG</td> <td>DO</td> </tr> </tbody> </table>	FIN 1			FIN 2		NO	BO	XV	BG	DO								
FIN 1			FIN 2																														
NO	BO	XV	CFP	BG	DO																												
FIN 1			FIN 2																														
NO	BO	XV	BG	DO																													
VANITY	<table border="1"> <thead> <tr> <th colspan="3">FIN 1</th> <th colspan="2">FIN 2</th> </tr> </thead> <tbody> <tr> <td>NO</td> <td>BO</td> <td>XV</td> <td>CFP</td> <td>BG</td> </tr> </tbody> </table>	FIN 1			FIN 2		NO	BO	XV	CFP	BG	DREAM	<table border="1"> <thead> <tr> <th colspan="3">FIN 1</th> <th colspan="4">FIN 2</th> </tr> </thead> <tbody> <tr> <td>NO</td> <td>BO</td> <td>XV</td> <td></td> <td></td> <td></td> <td></td> <td></td> </tr> </tbody> </table>	FIN 1			FIN 2				NO	BO	XV										
FIN 1			FIN 2																														
NO	BO	XV	CFP	BG																													
FIN 1			FIN 2																														
NO	BO	XV																															
CLASS LINE	<table border="1"> <thead> <tr> <th colspan="3">FIN 1</th> <th colspan="4">FIN 2</th> </tr> </thead> <tbody> <tr> <td>NO</td> <td>BO</td> <td>XV</td> <td></td> <td></td> <td></td> <td></td> <td></td> </tr> </tbody> </table>	FIN 1			FIN 2				NO	BO	XV						WINNER	<table border="1"> <thead> <tr> <th colspan="3">FIN 1</th> <th colspan="4">FIN 2</th> </tr> </thead> <tbody> <tr> <td>NO</td> <td>BO</td> <td>XV</td> <td></td> <td></td> <td></td> <td></td> <td></td> </tr> </tbody> </table>	FIN 1			FIN 2				NO	BO	XV					
FIN 1			FIN 2																														
NO	BO	XV																															
FIN 1			FIN 2																														
NO	BO	XV																															

Create unique furniture combinations by customizing the taps with finishing options. A range of 8 colors that easily fit into both classic and modern environments to meet the stylistic needs of the most creative projects.

REMER GROUP



Dal 1965, anno di fondazione di Remer Rubinetterie, il nostro viaggio è stato costellato di crescita, innovazione e costante evoluzione. In questi 60 anni la passione e l'impegno hanno guidato ogni nostra scelta; abbiamo abbracciato il cambiamento, non solo per restare al passo con i tempi, ma per anticiparli, portando sul mercato prodotti all'avanguardia. Ogni rubinetto, ogni tecnologia, ogni dettaglio è il frutto dell'amore per il nostro lavoro e della dedizione che ci spinge a offrire solo il meglio.

Oggi siamo una grande Famiglia composta da 250 dipendenti e da una rete di collaboratori che condividono la stessa filosofia e gli stessi valori: lavorare uniti, con dedizione e competenza, per dare sempre il massimo. Il nostro successo è il risultato di questa sinergia, che ci rende una forza unica e ci permette di realizzare ogni giorno il nostro obiettivo di eccellenza.

Nel festeggiare il nostro 60° ANNIVERSARIO, desideriamo esprimere un RINGRAZIAMENTO SPECIALE ai nostri Partner commerciali. Grazie alla vostra fiducia, alla condivisione di obiettivi e alla costante collaborazione, Remer Rubinetterie ha raggiunto traguardi straordinari. Ogni passo compiuto insieme, ogni progetto portato a termine e ogni sfida affrontata fianco a fianco ha consolidato un legame sincero e prezioso, arricchendo il nostro cammino e aggiungendo valore a ogni fase del nostro lavoro.

Il nostro 60° ANNIVERSARIO rappresenta molto più di una celebrazione. È un nuovo punto di partenza che ci ispira a guardare avanti con entusiasmo, determinazione e rinnovate ambizioni. Forti della vostra FIDUCIA, continueremo a stupirvi con soluzioni innovative, a sostenervi con impegno quotidiano e a crescere INSIEME, pronti a raggiungere nuovi orizzonti e a scrivere, insieme a voi, capitoli sempre più brillanti della nostra storia.



- Antonio Repici -

Since 1965, the year Remer Rubinetterie was founded, our journey has been marked by growth, innovation, and constant evolution. Over the past 60 years, passion and commitment have guided our every choice. We have embraced change, not only to keep pace with the times but to stay ahead, bringing cutting-edge products to the market. Every faucet, every technology, and every detail reflects our love for our work and the dedication that drives us to offer only the best.

Today, we are a large Family of 250 employees, along with a network of collaborators who share the same philosophy and values: to work together with dedication and skill to always give our very best. Our success is the result of this synergy, which makes us a unique force and enables us to fulfill our commitment to excellence every day.

As we celebrate our 60th ANNIVERSARY, we would like to extend a SPECIAL THANK YOU to our commercial Partners. Your trust, shared goals, and constant support have enabled Remer Rubinetterie to achieve remarkable milestones.

Every step taken together, every project completed, and every challenge faced side by side has strengthened a sincere and valuable bond, enriching our journey and adding value to each phase of our work.

Our 60th ANNIVERSARY is much more than a celebration. It is a new starting point that inspires us to look forward with enthusiasm, determination, and renewed ambitions. With your TRUST, we will continue to surprise you with innovative solutions, support you with daily dedication, and grow TOGETHER, ready to reach new horizons and write ever brighter chapters in our story alongside you.

LA FORZA DI UN GRANDE GRUPPO

THE STRENGTH OF A BIG GROUP



PERCHÉ SIAMO UN PARTNER SPECIALE

- Dipartimento interno di R&D, Design ed Engineering.
- Produzione interna di articoli fusi, stampati, da barra e da tubo di ottone con macchinari automatizzati e robotizzati di ultima generazione.
- Produzione interna al Gruppo di cartucce, deviatori, cartucce termostatiche e vitoni ceramici
- Produzione interna al Gruppo di flessibili.
- Produzione interna al Gruppo di componenti in plastica.
- Dipartimento interno al Gruppo per lo sviluppo e la produzione di tecnologie elettroniche
- Dipartimento di pulitura e lucidatura metalli
- Dipartimento di cromatura metalli
- Dipartimento di verniciatura metalli a liquido e polvere.
- Dipartimento di finitura galvanica di pregio.
- Dipartimento di pre-assemblaggio, controllo qualità e test prodotto ad aria ed acqua.
- Linee di assemblaggio automatiche.
- Circa 100 postazioni in radio frequenza.
- Supporto commerciale qualificato pre e post vendita.
- Gruppo con forte propensione all'investimento in nuovi macchinari produttivi (ulteriori novità nel 2025)

WHAT MAKES US A SPECIAL PARTNER

- *Internal R&D, Design, and Engineering Department.*
- *In-house production of casted, forged, brass bar, and tube articles using state-of-the-art automated and robotic machinery.*
- *In-house Group production of cartridges, diverters, thermostatic cartridges, and ceramic disc valves.*
- *In-house Group production of flexible hoses.*
- *In-house Group production of plastic components.*
- *Internal Group department for the development and production of electronic technologies.*
- *In-house metal cleaning and polishing department.*
- *In-house metal chrome plating department.*
- *In-house liquid and powder metal vanishing department.*
- *High-end galvanic finishing department.*
- *Pre-assembly department, quality control, air and water product testing.*
- *Automatic assembly lines.*
- *Approximately 100 radio-frequency workstations.*
- *Qualified commercial support for pre- and post-sales services.*
- *A Group strongly oriented toward investing in new production machinery (additional innovations expected in 2025).*

REMER GROUP

FACTORY



TOUR

Cassano d'Adda (MI) - Italy
Lat: 45° 31' 37" N Long: 9° 30' 11" E



ENGINEERING 1
Dipartimento di produzione con macchinari high-tech, asserviti e robotizzati
Department of production with high-tech machineries, asserved and robotized



Dipartimento di preassemblaggio e test, dipartimento con impianti di verniciatura a polvere e liquido, dipartimento e impianto di galvanica per la produzione di articoli di pregio. *Pre-assembly and test facilities, powder and liquid vanishing plant and facilities, high- end galvanic electroplating department, plant and facilities.*

REMER



VANISHING AND HIGH END GALVANIC





ENGINEERING 2

Dipartimento di produzione con macchinari high-tech, asserviti e robotizzati. Uffici tecnici e R&D.
Department of production with high-tech machineries, asserved and robotized. Technical and R&D departments



Produzione flessibili.
Flexible hoses production.



Sede operativa, controllo finale, spedizioni, uffici commerciali, amministrativi
Head offices and factory.

Dipartimento di pulitura, pre-assemblaggio, test di tenuta e controllo qualità.
Polishing department, Test department, pre-assembly department.

POLISHING, PRE-ASSEMBLY, QUALITY



FLEXITALY



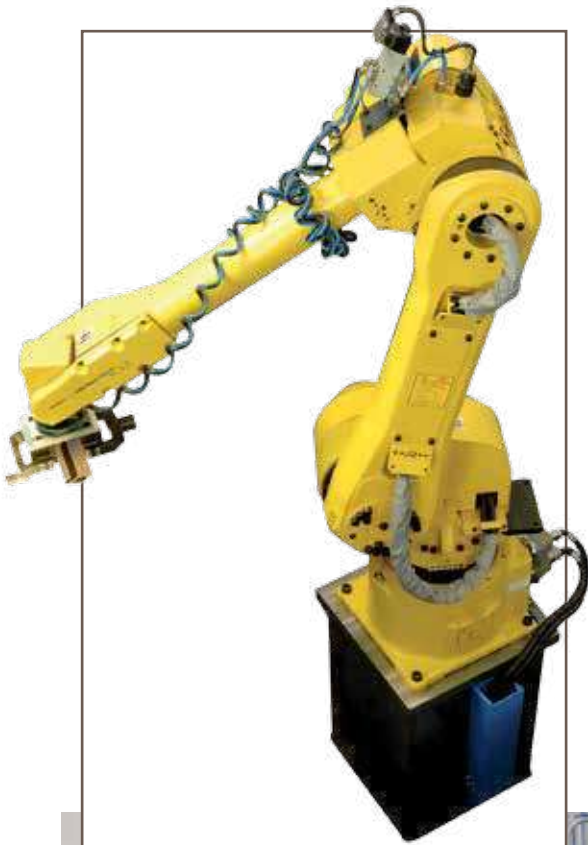

REMER ENGINEERING 1



Produzione high-tech, R.&D.
High-tech production, R.&D.



Dipartimento di produzione con macchinari high-tech, asserviti e robotizzati, per la tornitura di corpi fusi e stampati e area per lavorazioni combibar.
Department of production with high-tech machineries, asserved and robotized, for the turning of cast and molded bodies and area for combibar machining.

REMER ENGINEERING 2



Produzione high-tech di componenti da barra - *High-tech production for components made from bar*



PULITURA POLISHING DEPARTMENT



Macchine automatiche di pulitura con bracci robotizzati, a tavola rotante ed a doppia robotizzazione. *Automatic polishing machines with robotic arms, a rotating table and even a double robotization.*



VERNICIATURA VANISHING DEPARTMENT



Impianto semi-automatico interno per la verniciatura decorativa
Internal semi-automatic vanishing plant for decorative colorings

FINISHING DEPARTMENT

GALVANICA DI PREGIO HIGH-END GALVANIC



Reparto interno di finitura
galvanica di pregio
*Internal department for high-end
galvanic finishing*



CROMATURA CHROME PLATING PLANT



Grande impianto interno per la cromatura
decorativa
*Big internal plant for decorative chrome
plating*





SOLO CARTUCCE, DEVIATORI, THERMOSTATICI E COMPONENTI ELETTRONICI DI ALTA QUALITÀ E MADE IN ITALY

Tutti i miscelatori ed i prodotti a contenuto elettronico REMER godono di una garanzia di qualità aggiuntiva.

Cartucce a dischi ceramici per monocomando, deviatori per doccia, cartucce termostatiche e componenti elettronici sono tutti prodotti in Italia da S.T.S.R. - Studio Tecnico Sviluppo e Ricerche - con stabilimenti a Lacchiarella - MI - e sito internet www.stsr.it

ONLY HIGH QUALITY AND MADE IN ITALY CARTRIDGES, DIVERTERS, THERMOSTATICS AND ELECTRONICS

All REMER mixers and products with electronic parts have an additional quality guarantee.

Ceramic disk cartridges for single-lever mixers, diverters for shower, thermostatic cartridges and electronic components are all produced in Italy by S.T.S.R. - Studio Tecnico Sviluppo e Ricerche - with plants in Lacchiarella - MI - and website www.stsr.it



S.T.S.R. nasce nel 1985 come Studio Tecnico di Sviluppo e Ricerca producendo nel corso degli anni svariati brevetti sia relativi a cartucce che a prodotti elettronici. Al suo interno sono presenti macchinari all'avanguardia che coprono il ciclo produttivo dallo stampaggio delle speciali plastiche utilizzate fino all'assemblaggio e test su macchine automatiche di ultima generazione.

I prodotti S.T.S.R. godono inoltre di svariate Certificazioni. È per noi importante dotare i nostri miscelatori di una cartuccia di alta qualità, questo valore aggiunto dona agli articoli REMER caratteristiche superiori a conferma di qualità e del nostro made in ITALY.

S.T.S.R. was founded in 1985 as the Development and Research Technical Department, producing several patents related both to cartridges and electronic products over the years. Inside there is cutting-edge machinery covering the production cycle from the molding of special plastics up to the assembly and testing of latest generation automatic machines.

S.T.S.R. products also have various certifications. It is important for us to equip our mixers with a high quality cartridge, this added value gives to REMER articles superior characteristics as a confirmation of quality and of our made in ITALY.

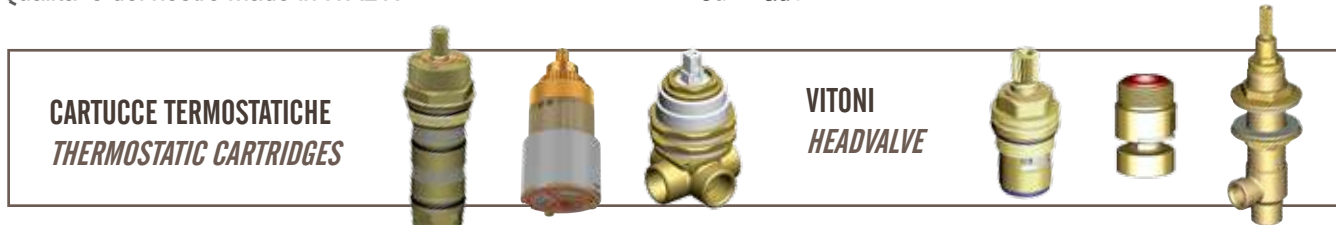

**UN ULTERIORE PLUS DEI PRODOTTI REMER
A FURTHER PLUS OF REMER PRODUCTS**

REMER
RUBINETTERIE



**FLESSIBILI MADE IN ITALY DI
ALTA QUALITÀ PRODOTTI CON
MACCHINARI AUTOMATIZZATI A
GARANZIA DI ELEVATI STANDARD.**

**MADE IN ITALY FLEXIBLE HOSES
OF HIGH QUALITY MADE BY
AUTOMATIC MACHINERIES FOR A
PERFECT PRODUCT.**

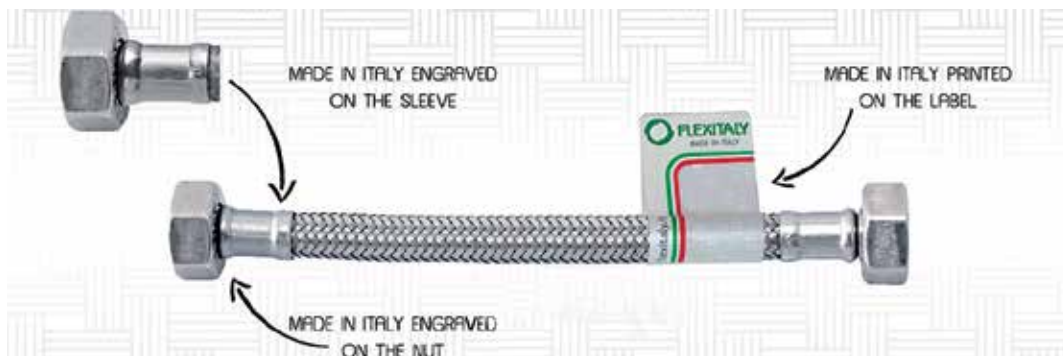

I prodotti REMER utilizzano solamente flessibili di alta qualità prodotti in Italia con macchinari automatizzati a garanzia di elevati standard. Flexitaly s.r.l., è una azienda facente parte del Gruppo REMER.

REMER products use only high quality flexible hoses produced in Italy with automated machinery in order to guarantee high standards. Flexitaly s.r.l., is a company belonging to the REMER Group.

Nata nel 1985, Flexitaly è dotata di propri stabilimenti ed impianti che iniziano il processo produttivo partendo dalla trecciatura del tubo (gomma epdm e filo secondo specifica) e, con l'ausilio di minuterie e raccorderie create internamente con i migliori materiali seguendo minuziosamente le tolleranze e macchine automatizzate specifiche, coprono l'intero ciclo produttivo, rendendo alla clientela un prodotto completamente made in Italy, ideato e poi creato per essere totalmente performante, atossico ed estremamente durevole nel tempo.

Founded in 1985, Flexitaly has its own plants, carrying on the production process starting from the hose braiding (epdm rubber and wire according to specification) and covering the entire production cycle with the help of small parts and fittings created in-house with the best materials, carefully following the tolerances and specific automated machines, thus offering to customers a product completely made in Italy, designed and then created to be totally performing, non-toxic and extremely durable over time.

Un ulteriore plus per i prodotti REMER.

A further plus for REMER products.



YOU'RE WELCOME

CERTIFICATIONS

Remer Rubinetterie S.p.A. è un'azienda certificata
UNI EN ISO 9001:2008 sistema di gestione qualità aziendale
e UNI EN ISO 14001: 2004 per l'impatto ambientale.

*Remer Rubinetterie S.p.A. is a
UNI EN ISO 9001:2008 certified factory for the quality system
and UNI EN ISO 14001: 2004 for environmental impact.*





REMER SALVS PER AQVAM







ARREDARE IL BAGNO
FURNISHING THE BATHROOM

ATELIER

IL GRANDE PASSATO DISEGNA IL PRESENTE
THE GREAT PAST DRAWS THE PRESENT



Nella collezione di miscelatori monocomando ATELIER, i dettagli decorativi dallo stile classico impreziosiscono le superfici di leva, basetta e aeratore, creando un equilibrio di assoluta eleganza con le forme più moderne e minimali del corpo. La collezione si sviluppa su una cartuccia dal diametro di 25mm, 35mm per le figure a incasso.

In the ATELIER single-lever mixer collection, classically styled decorative details adorn the surfaces of the lever, base and aerator, creating a balance of absolute elegance with the more modern and minimalist shapes of the body. The collection is developed on a 25mm diameter cartridge, 35mm for the built-in items.





AL08NO



ATELIER

AL10ACCNO



AL53D2PWBRP



AL12ADO

//////////////////////////////////// OPZIONI DI FINITURA - FINISHING OPTIONS //////////////////////////////////////

CR		FIN 1		FIN 2	
	cromo chrome		nero opaco matt black		cromo nero spazzolato brushed black chrome
	CR		bianco opaco matt white		oro spazzolato brushed gold
			visual inox visual steel		oro lucido shiny gold
			oil bronze oil bronze		rame spazzolato brushed copper
			NO		CFP
			BO		BG
			XV		DO
			BR		RP

MISCELATORI LAVABO - WASHBASIN MIXERS



AL10
Miscelatore monocomando per lavabo, con scarico.
Single-lever basin mixer, with pop-up waste.

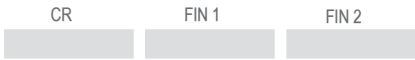

AL10ACC
Miscelatore monocomando per lavabo, modello "A" altezza media, scarico click-clack con troppo-pieno incluso.
Single-lever basin mixer, model "A" medium height, click-clack waste with overflow included.

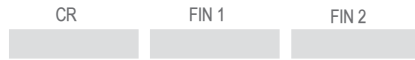

AL10LXL
Miscelatore monocomando alto per lavabo, misura XL, scarico click-clack con troppo-pieno incluso.
High single-lever washbasin mixer, XL size, click-clack waste with overflow included..

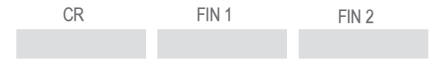

AL12
Miscelatore monocomando per lavabo, senza scarico e senza foro posteriore sul corpo.
Single-lever basin mixer, without waste and without rear body hole.

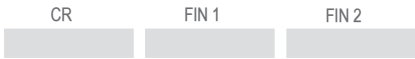

AL12A
Miscelatore monocomando per lavabo, modello "A" altezza media, senza scarico e senza foro sul corpo.
Single-lever basin mixer, model "A" medium height, without pop-up waste and with no rear hole.

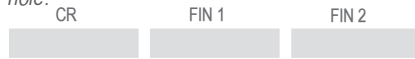

AL11LXL
Miscelatore monocomando alto per lavabo, misura XL, scarico non incluso.
High single-lever washbasin mixer, XL size, waste not included.

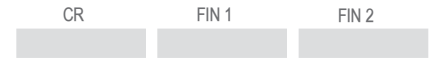

AL57
Miscelatore monocomando per lavabo a due fori. Scarico non incluso.
2-holes single-lever basin mixer. Waste not included.



AL57L
Miscelatore monocomando per lavabo a due fori, con bocca L. Scarico non incluso.
2-holes single-lever basin mixer, with L spout. Waste not included.



AL15
Miscelatore monocomando a incasso per lavabo. Piastra ultra-piatta. Lunghezza bocca 17 cm.
Single-lever built-it basin mixer. Ultra-flat plate. Spout length 17 cm.



AL15L
Miscelatore monocomando a incasso per lavabo. Piastra ultra-piatta. Lunghezza bocca 19 cm.
Single-lever built-it basin mixer. Ultra-flat plate. Spout length 19 cm.





AL15P

Miscelatore monocomando a incasso per lavabo, su due piastre tonde separate. Lunghezza bocca 17 cm.

Built-in single-lever basin mixer with two separate round plates. Spout length 17 cm.

CR FIN 1 FIN 2

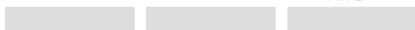

AL15PL

Miscelatore monocomando a incasso per lavabo, su due piastre tonde separate. Lunghezza bocca 19 cm.

Built-in single-lever basin mixer with two separate round plates. Spout length 19 cm.

CR FIN 1 FIN 2



AL18

Miscelatore monocomando da pavimento per lavabo, scarico click-clack con troppo-pieno incluso, articolo completo.

Floor mounting single-lever basin mixer, click-clack waste with overflow included, complete product.

CR FIN 1 FIN 2

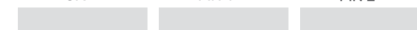

Q08FIS2

Solo parte interna.
Built-in components only.



CR

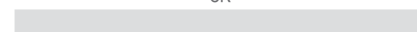

AL18E

Solo parti esterne.
Exposed components only.

CR FIN 1 FIN 2

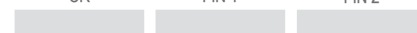

LAVABO A MURO CON BOX INCASSO - WALL WASHBASIN MIXER WITH BUILT-IN BOX



SOLO PARTE ESTERNA - EXPOSED COMPONENTS ONLY:

AL15WB

Parti esterne per miscelatore monocomando a incasso per lavabo da abbinare al box incasso (non incluso). Piastra ultra-piatta. Lunghezza bocca 17 cm.

Exposed components for single-lever built-in basin mixer, with ultra-flat wall plate. To match with the built-in box (not included). Spout length 17 cm.

CR FIN 1 FIN 2

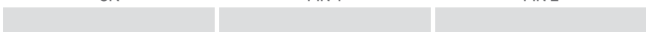

AL15LWB

Idem sopra, con lunghezza bocca 19 cm.
Same as above, with spout length 19 cm.

CR FIN 1 FIN 2

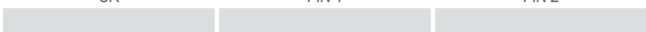

SOLO PARTE ESTERNA - EXPOSED COMPONENTS ONLY:

AL15PWB

Parti esterne per miscelatore monocomando a incasso per lavabo da abbinare al box incasso (non incluso). Su due piastre tonde separate. Lunghezza bocca 17 cm.

Exposed components for single-lever built-in basin mixer, with two separate round plates. To match with the built-in box (not included). Spout length 17 cm.

CR FIN 1 FIN 2

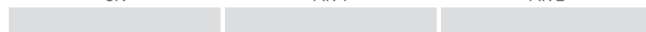

AL15PLWB

Idem sopra, con lunghezza bocca 19 cm.
Same as above, with spout length 19 cm.

CR FIN 1 FIN 2



SOLO PARTE INTERNA - BUILT-IN COMPONENTS ONLY:

WBOX15

SOLO PARTE INTERNA - BUILT-IN COMPONENTS ONLY:

WBOX15

MISCELATORI PER BIDET - BIDET MIXERS



AL20
Miscelatore monocomando per bidet, con scarico.
Single-lever bidet mixer, with pop-up waste.



AL22
Miscelatore monocomando per bidet, senza scarico e senza foro posteriore sul corpo.
Single-lever bidet mixer, without waste and without rear body hole.

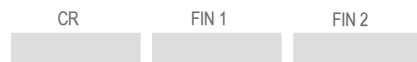

AL65Z
Set shut-off comprensivo di: miscelatore a incasso con supporto doccia/presa acqua, doccetta a pulsante(332OZ), tutto in ottone. Flessibile doccia cm 120.
Shut-off set including: built-in mixer with shower holder/water punch on flange, shut-off hand shower (332OZ), all in brass. Flexible hose cm 120.

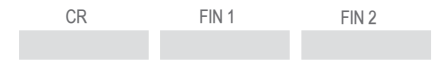

MISCELATORI ESTERNI PER VASCA - EXPOSED MIXERS FOR BATH

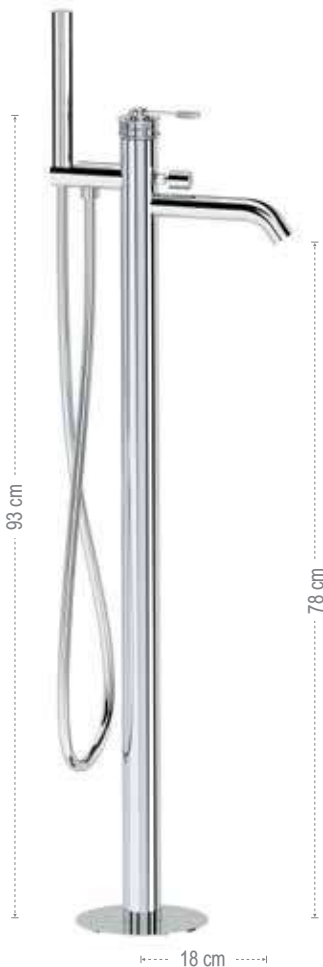

AL08
Miscelatore bordo vasca da pavimento, con deviatore e kit doccetta in ottone. Prodotto completo.
Floor mounting single-lever bath mixer, with diverter and brass hand shower kit. Complete product.



Q08FIS2
Solo parte interna.
Built-in components only.



AL08E
Solo parti esterne.
Exposed components only.



AL02
Miscelatore monocomando per vasca, con kit doccetta in ottone ad 1 funzione. Flessibile 150cm.
Wall mounted single-lever bath mixer with 1-function brass hand shower kit. 150cm flexible hose.

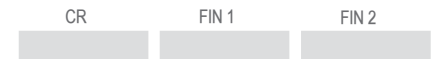

AL05
Miscelatore monocomando per vasca, senza kit doccia.
Wall mounted single-lever bath mixer, without shower kit.



MISCELATORI A INCASSO PER VASCA - BUILT-IN MIXERS FOR BATH

ATELIER

CHRONO

CELEBRITY

ELEMENT

Q DESIGN

X-STYLE

2 VIE
WAYS

SOLO PARTE ESTERNA - EXPOSED COMPONENTS ONLY:

AL53D2PWB

Set a incasso a 2 vie per vasca su piastre tonde separate.
2-way built-in set for bathtub on separate round plates.

CR

FIN 1

FIN 2



SOLO PARTE INTERNA - BUILT-IN COMPONENTS ONLY:

WBOX97D2

pag 304



SOLO PARTE ESTERNA - EXPOSED COMPONENTS ONLY:

AL53D2WB

Set a incasso a 2 vie per vasca su piastra unica rettangolare.
2-way built-in set for bathtub on a single rectangular plate.

CR

FIN 1

FIN 2



SOLO PARTE INTERNA - BUILT-IN COMPONENTS ONLY:

WBOX97D2

pag 304

2 VIE
WAYS

SOLO PARTE ESTERNA - EXPOSED COMPONENTS ONLY:

AL54D2PWB

Set miscelatore a incasso a 2 vie per vasca/doccia su 3 piastre tonde. Da completare con la seconda uscita acqua.
2-way built-in mixer set for bathtub / shower on 3 round plates. To be completed with the second water outlet.

CR

FIN 1

FIN 2

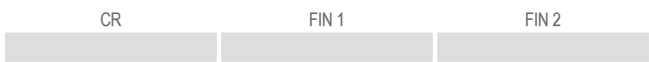

SOLO PARTE INTERNA - BUILT-IN COMPONENTS ONLY:

WBOX97D2

pag 304



SOLO PARTE ESTERNA - EXPOSED COMPONENTS ONLY:

AL54D2WB

Set miscelatore a incasso a 2 vie per vasca/doccia su piastra unica rettangolare. Da completare con la seconda uscita.
2-way built-in mixer set for bathtub / shower on single rectangular plate. To be completed with the second water outlet.

CR

FIN 1

FIN 2

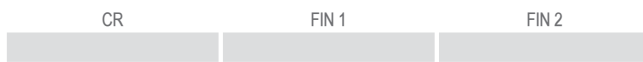

SOLO PARTE INTERNA - BUILT-IN COMPONENTS ONLY:

WBOX97D2

pag 304

3 VIE
WAYS

SOLO PARTE ESTERNA - EXPOSED COMPONENTS ONLY:

AL54D3PWB

Set miscelatore a incasso a 3 vie per vasca/doccia su 3 piastre tonde. Da completare con la seconda e la terza uscita acqua.
3-way built-in mixer set for bathtub / shower on 3 separate round plates. To be completed with the second and the third water outlet.

CR

FIN 1

FIN 2



SOLO PARTE INTERNA - BUILT-IN COMPONENTS ONLY:

WBOX97D3

pag 308



SOLO PARTE ESTERNA - EXPOSED COMPONENTS ONLY:

AL54D3WB

Set miscelatore a incasso a 3 vie per vasca/doccia su piastra unica rettangolare. Da completare con la seconda e la terza uscita acqua.
3-way built-in mixer set for bathtub / shower on single rectangular plate. To be completed with the second and the third water outlet.

CR

FIN 1

FIN 2



SOLO PARTE INTERNA - BUILT-IN COMPONENTS ONLY:

WBOX97D3

pag 308

Set doccia acquistabile separatamente a pagina 427 - Shower set can be purchased separately on page 427

MISCELATORI A INCASSO PER DOCCIA - BUILT-IN MIXERS FOR SHOWER



AL30L

Miscelatore a incasso per doccia, su piastra tonda ultra-piatta.
Built-in shower mixer, ultra-flat round wall plate.



AL30Q

Miscelatore a incasso per doccia, su piastra quadrata ultra-piatta.
Built-in shower mixer, ultra-flat square wall plate.



SOLO PARTE ESTERNA - EXPOSED COMPONENTS ONLY:

AL92ZPWB

Miscelatore a incasso per vasca/doccia con deviatore a 2 vie di tipo meccanico, su due piastre tonde.
Built-in bath/shower mixer with 2-way mechanical diverter, on two round plates.

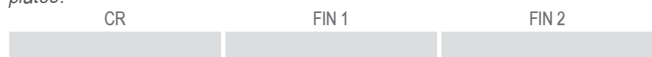

SOLO PARTE ESTERNA - EXPOSED COMPONENTS ONLY:

AL92ZWB

Miscelatore a incasso per vasca/doccia con deviatore a 2 vie di tipo meccanico, su piastra rettangolare.
Built-in bath/shower mixer with 2-way mechanical diverter, on rectangular plate.



SOLO PARTE INTERNA - BUILT-IN COMPONENTS ONLY:

WBOX92Z

pag 300

SOLO PARTE INTERNA - BUILT-IN COMPONENTS ONLY:

WBOX92Z

pag 300



AL09HL

Miscelatore a incasso per vasca/doccia con deviatore a 2 vie a vitone ceramico. Per selezionare l'uscita desiderata, la manopola del deviatore deve essere ruotata da una posizione all'altra.
Built-in bath/shower mixer with 2-way diverter with ceramic head valve. To select the desired output, the diverter knob must be turned from one position to the other.



AL09HRG

Miscelatore a incasso per vasca/doccia con deviatore a 2 vie con vitone ceramico, su piastra rettangolare, montaggio orizzontale. Per selezionare l'uscita desiderata, la manopola del deviatore deve essere ruotata da una posizione all'altra.
Built-in bath/shower mixer with 2-way diverter with ceramic head valve, on rectangular plate, horizontal mounting. To select the desired output, the diverter knob must be turned from one position to the other.



N09HB

Solo parte interna.
Built-in components only.



AL09LE

Solo parte esterna.
Exposed components only.



N09HRB

Solo parte interna.
Built-in components only.



AL09GE

Solo parte esterna.
Exposed components only.



2 VIE
WAYS

SOLO PARTE ESTERNA - EXPOSED COMPONENTS ONLY:

AL97D2PWB

Set miscelatore a incasso a 2 vie per vasca/doccia su 3 piastre tonde.
Da completare con la seconda uscita.
2-way built-in shower mixer set on 3 round plates. To be completed with the second water outlet.

CR

FIN 1

FIN 2



SOLO PARTE INTERNA - BUILT-IN COMPONENTS ONLY:

WBOX97D2

pag 304



SOLO PARTE ESTERNA - EXPOSED COMPONENTS ONLY:

AL97D2WB

Set miscelatore a incasso a 2 vie per vasca/doccia su piastra rettangolare.
Da completare con la seconda uscita.
2-way built-in shower mixer set on rectangular plate. To be completed with the second water outlet.

CR

FIN 1

FIN 2



SOLO PARTE INTERNA - BUILT-IN COMPONENTS ONLY:

WBOX97D2

pag 304

3 VIE
WAYS

SOLO PARTE ESTERNA - EXPOSED COMPONENTS ONLY:

AL93ZPWB

Miscelatore a incasso per vasca/doccia con deviatore a 3 vie di tipo meccanico, su due piastre tonde.
Built-in bath/shower mixer with 3-way mechanical diverter, on two round plates.

CR

FIN 1

FIN 2

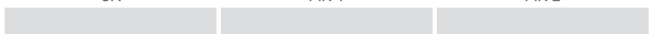

SOLO PARTE INTERNA - BUILT-IN COMPONENTS ONLY:

WBOX93Z

pag 302



SOLO PARTE ESTERNA - EXPOSED COMPONENTS ONLY:

AL93ZWB

Miscelatore a incasso per vasca/doccia con deviatore a 3 vie di tipo meccanico, su piastra rettangolare.
Built-in bath/shower mixer with 3-way mechanical diverter, on rectangular plate.

CR

FIN 1

FIN 2

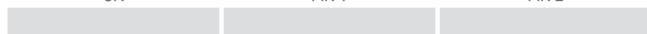

SOLO PARTE INTERNA - BUILT-IN COMPONENTS ONLY:

WBOX93Z

pag 302

3 VIE
WAYS

SOLO PARTE ESTERNA - EXPOSED COMPONENTS ONLY:

AL97D3PWB

Set miscelatore a incasso a 3 vie per vasca/doccia su 3 piastre tonde. Da completare con la seconda e la terza uscita acqua.
3-way built-in bath/shower mixer set on 3 round plates. To be completed with the second and the third water outlet.

CR

FIN 1

FIN 2



SOLO PARTE INTERNA - BUILT-IN COMPONENTS ONLY:

WBOX97D3

pag 308



SOLO PARTE ESTERNA - EXPOSED COMPONENTS ONLY:

AL97D3WB

Set miscelatore a incasso a 3 vie per vasca/doccia su piastra rettangolare. Da completare con la seconda e la terza uscita acqua.
3-way built-in shower mixer set on rectangular plate. To be completed with the second and the third water outlet.

CR

FIN 1

FIN 2



SOLO PARTE INTERNA - BUILT-IN COMPONENTS ONLY:

WBOX97D3

pag 308

CHRONO

**ISPIRATA AGLI INGRANAGGI MECCANICI DI PRECISIONE
INSPIRED BY PRECISION MECHANICAL GEARS**



CHRONO è una collezione di miscelatori monocomando con un forte richiamo agli ingranaggi del tempo. La scelta di rubinetteria ideale per accompagnare uno stile di interni urbano e industriale. Cartuccia diametro 25mm, 35mm per le figure a incasso.

CHRONO is a collection of single lever mixers with a strong reference to the gears of time. The perfect choice of faucets to match an industrial and urban interior style. 25mm diameter cartridge, 35mm for the built-in items.





CH15P

CHRONO



CH53D2PWB

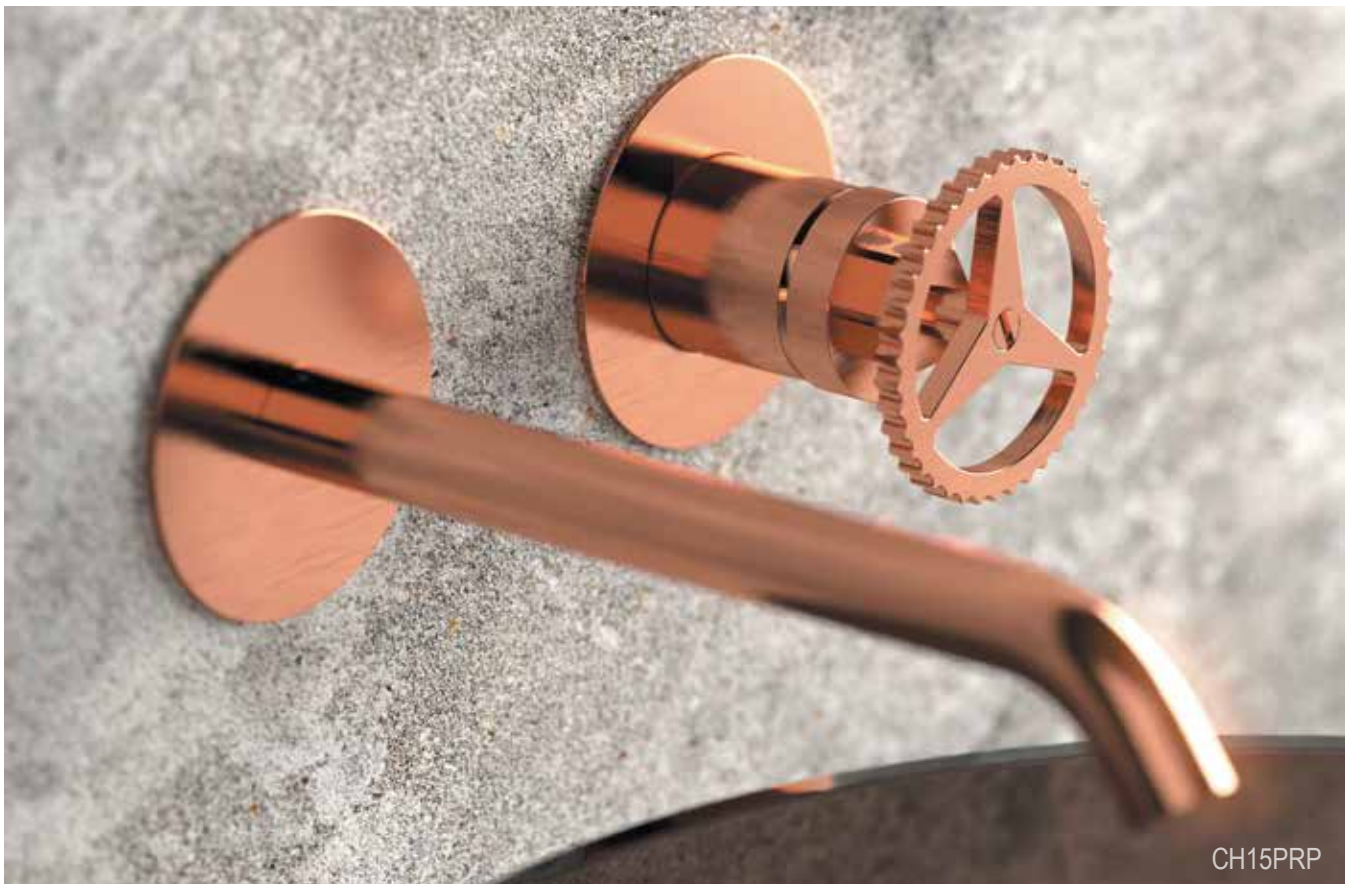



CH12BG

//////////////////// OPZIONI DI FINITURA - FINISHING OPTIONS //////////////////////

CR		FIN 1		FIN 2	
	cromo chrome		nero opaco matt black		cromo nero spazzolato brushed black chrome
	CR		bianco opaco matt white		oro spazzolato brushed gold
			visual inox visual steel		oro lucido shiny gold
			oil bronze oil bronze		rame spazzolato brushed copper
			NO		CFP
			BO		BG
			XV		DO
			BR		RP

MISCELATORI LAVABO - WASHBASIN MIXERS



CH10
 Miscelatore monocomando per lavabo, con scarico.
Single-lever basin mixer, with pop-up waste.



CH10ACC
 Miscelatore monocomando per lavabo, modello "A" altezza media, scarico click-clack con troppo-pieno incluso.
Single-lever basin mixer, model "A" medium height, click-clack waste with overflow included.



CH10LXL
 Miscelatore monocomando alto per lavabo, misura XL, scarico click-clack con troppo-pieno incluso.
High single-lever washbasin mixer, XL size, click-clack waste with overflow included.



CH12
 Miscelatore monocomando per lavabo, senza scarico e senza foro posteriore sul corpo.
Single-lever basin mixer, without waste and without rear body hole.



CH12A
 Miscelatore monocomando per lavabo, modello "A" altezza media, senza scarico e senza foro sul corpo.
Single-lever basin mixer, model "A" medium height, without pop-up waste and with no rear hole.



CH11LXL
 Miscelatore monocomando alto per lavabo, misura XL, scarico non incluso.
High single-lever washbasin mixer, XL size, waste not included.

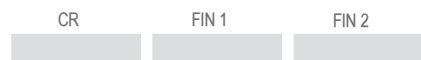

CH57
 Miscelatore monocomando per lavabo a due fori. Scarico non incluso.
2-holes single-lever basin mixer. Waste not included.



CH57L
 Miscelatore monocomando per lavabo a due fori, con bocca L. Scarico non incluso.
2-holes single-lever basin mixer, with L spout. Waste not included.



CH15
 Miscelatore monocomando a incasso per lavabo. Piastra ultra-piatta. Lunghezza bocca 17 cm.
Single-lever built-it basin mixer. Ultra-flat plate. Spout length 17 cm.

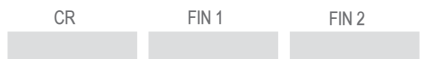

CH15L
 Miscelatore monocomando a incasso per lavabo. Piastra ultra-piatta. Lunghezza bocca 19 cm.
Single-lever built-it basin mixer. Ultra-flat plate. Spout length 19 cm.





CH15P

Miscelatore monocomando a incasso per lavabo, su due piastre tonde separate. Lunghezza bocca 17 cm.

Built-in single-lever basin mixer with two separate round plates. Spout length 17 cm.



CH15PL

Miscelatore monocomando a incasso per lavabo, su due piastre tonde separate. Lunghezza bocca 19 cm.

Built-in single-lever basin mixer with two separate round plates. Spout length 19 cm.

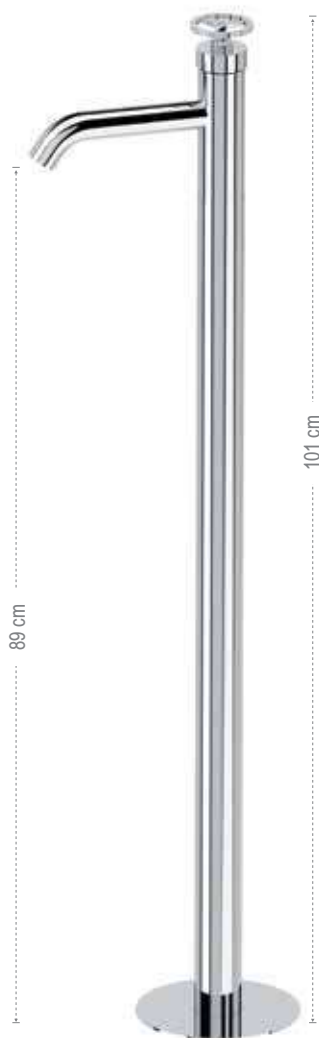

CH18

Miscelatore monocomando da pavimento per lavabo, scarico click-clack con troppo-pieno incluso. Prodotto completo.

Floor mounting single-lever basin mixer, click-clack waste with overflow included. Complete product.



Q08FIS2

Solo parte interna.
Built-in components only.



CH18E

Solo parti esterne.
Exposed components only.



LAVABO A MURO CON BOX INCASSO - WALL WASHBASIN MIXER WITH BUILT-IN BOX



SOLO PARTE ESTERNA - EXPOSED COMPONENTS ONLY:

CH15WB

Parti esterne per miscelatore monocomando a incasso per lavabo da abbinare al box incasso (non incluso). Piastra ultra-piatta. Lunghezza bocca 17 cm.
Exposed components for single-lever built-in basin mixer, with ultra-flat wall plate. To match with the built-in box (not included). Spout length 17 cm.



CH15LWB

Idem sopra, con lunghezza bocca 19 cm.
Same as above, with spout length 19 cm.



SOLO PARTE ESTERNA - EXPOSED COMPONENTS ONLY:

CH15PWB

Parti esterne per miscelatore monocomando a incasso per lavabo da abbinare al box incasso (non incluso). Su due piastre tonde separate. Lunghezza bocca 17 cm.

Exposed components for single-lever built-in basin mixer, with two separate round plates. To match with the built-in box (not included). Spout length 17 cm.



CH15PLWB

Idem sopra, con lunghezza bocca 19 cm.
Same as above, with spout length 19 cm.



SOLO PARTE INTERNA - BUILT-IN COMPONENTS ONLY:

WBOX15

SOLO PARTE INTERNA - BUILT-IN COMPONENTS ONLY:

WBOX15

MISCELATORI PER BIDET - BIDET MIXERS



CH20
Miscelatore monocomando per bidet, con scarico.
Single-lever bidet mixer, with pop-up waste.



CH22
Miscelatore monocomando per bidet, senza scarico e senza foro posteriore sul corpo.
Single-lever bidet mixer, without waste and without rear body hole.



CH65W
Set shut-off comprensivo di: miscelatore a incasso con supporto doccia/presa acqua, doccetta a pulsante, tutto in ottone. Flessibile doccia cm 120.
Shut-off set including: built-in mixer with shower holder/water punch on flange, shut-off hand shower, all in brass. Flexible hose cm 120.

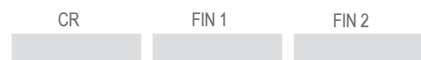

MISCELATORI ESTERNI PER VASCA E DOCCIA - EXPOSED MIXERS FOR BATH AND SHOWER

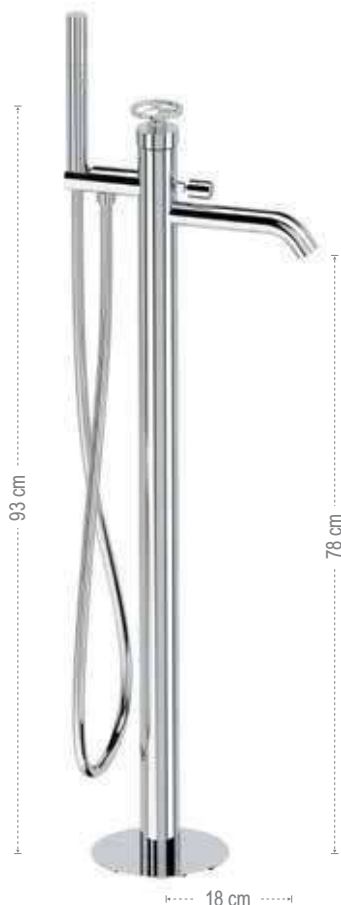

CH08
Miscelatore bordo vasca da pavimento, con deviatore e kit doccetta in ottone. Prodotto completo.
Floor mounting single-lever bath mixer, with diverter and brass hand shower kit. Complete product.

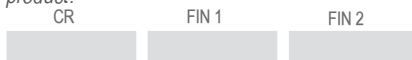

Q08FIS2
Solo parte interna.
Built-in components only.



CH08E
Solo parti esterne.
Exposed components only.



CH02
Miscelatore monocomando per vasca, con kit doccetta in ottone ad 1 funzione. Flessibile 150cm.
Wall mounted single-lever bath mixer with 1-function brass hand shower kit. 150cm flexible hose.



CH05
Miscelatore monocomando per vasca, senza kit doccia.
Wall mounted single-lever bath mixer, without shower kit.





CH08DO

MISCELATORI INCASSO PER VASCA - BUILT-IN MIXERS FOR BATH



2 VIE
WAYS



SOLO PARTE ESTERNA - EXPOSED COMPONENTS ONLY:

CH53D2PWB

Set a incasso a 2 vie per vasca su piastre tonde separate.
2-way built-in set for bathtub on separate round plates.

CR FIN 1 FIN 2

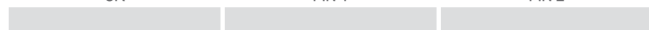

SOLO PARTE INTERNA - BUILT-IN COMPONENTS ONLY:

WBOX97D2

> pag 304



SOLO PARTE ESTERNA - EXPOSED COMPONENTS ONLY:

CH53D2WB

Set a incasso a 2 vie per vasca su piastra unica rettangolare.
2-way built-in set for bathtub on a single rectangular plate.

CR FIN 1 FIN 2

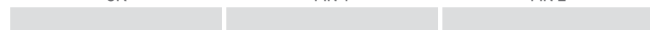

SOLO PARTE INTERNA - BUILT-IN COMPONENTS ONLY:

WBOX97D2

> pag 304



2 VIE
WAYS



SOLO PARTE ESTERNA - EXPOSED COMPONENTS ONLY:

CH54D2PWB

Set miscelatore a incasso a 2 vie per vasca/doccia su 3 piastre tonde. Da completare con la seconda uscita acqua.
2-way built-in mixer set for bathtub / shower on 3 round plates. To be completed with the second water outlet.

CR FIN 1 FIN 2

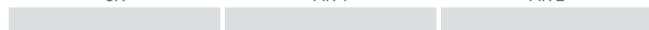

SOLO PARTE INTERNA - BUILT-IN COMPONENTS ONLY:

WBOX97D2

> pag 304



SOLO PARTE ESTERNA - EXPOSED COMPONENTS ONLY:

CH54D2WB

Set miscelatore a incasso a 2 vie per vasca/doccia su piastra unica rettangolare. Da completare con la seconda uscita.
2-way built-in mixer set for bathtub / shower on single rectangular plate. To be completed with the second water outlet.

CR FIN 1 FIN 2

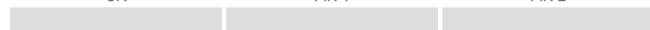

SOLO PARTE INTERNA - BUILT-IN COMPONENTS ONLY:

WBOX97D2

> pag 304



3 VIE
WAYS



SOLO PARTE ESTERNA - EXPOSED COMPONENTS ONLY:

CH54D3PWB

Set miscelatore a incasso a 3 vie per vasca/doccia su 3 piastre tonde. Da completare con la seconda e la terza uscita acqua.
3-way built-in mixer set for bathtub / shower on 3 separate round plates. To be completed with the second and the third water outlet.

CR FIN 1 FIN 2

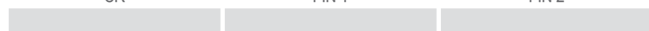

SOLO PARTE INTERNA - BUILT-IN COMPONENTS ONLY:

WBOX97D3

> pag 308



SOLO PARTE ESTERNA - EXPOSED COMPONENTS ONLY:

CH54D3WB

Set miscelatore a incasso a 3 vie per vasca/doccia su piastra unica rettangolare. Da completare con la seconda e la terza uscita acqua.
3-way built-in mixer set for bathtub / shower on single rectangular plate. To be completed with the second and the third water outlet.

CR FIN 1 FIN 2

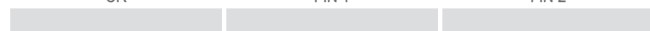

SOLO PARTE INTERNA - BUILT-IN COMPONENTS ONLY:

WBOX97D3

> pag 308

Set doccia acquistabile separatamente a pagina 427 - *Shower set can be purchased separately on page 427*

MISCELATORI INCASSO PER DOCCIA - BUILT-IN MIXERS FOR SHOWER

ATELIER



CH30L

Miscelatore a incasso per doccia, su piastra tonda ultra-piatta.
Built-in shower mixer, ultra-flat round wall plate.

CR FIN 1 FIN 2



CH30Q

Miscelatore a incasso per doccia, su piastra quadrata ultra-piatta.
Built-in shower mixer, ultra-flat square wall plate.

CR FIN 1 FIN 2

CHRONO



SOLO PARTE ESTERNA - EXPOSED COMPONENTS ONLY:

CH92ZPWB

Miscelatore a incasso per vasca/doccia con deviatore a 2 vie di tipo meccanico, su due piastre tonde.
Built-in bath/shower mixer with 2-way mechanical diverter, on two round plates.

CR FIN 1 FIN 2



SOLO PARTE ESTERNA - EXPOSED COMPONENTS ONLY:

CH92ZWB

Miscelatore a incasso per vasca/doccia con deviatore a 2 vie di tipo meccanico, su piastra rettangolare.
Built-in bath/shower mixer with 2-way mechanical diverter, on rectangular plate.

CR FIN 1 FIN 2

CELEBRITY

SOLO PARTE INTERNA - BUILT-IN COMPONENTS ONLY:

WBOX92Z

pag 300

SOLO PARTE INTERNA - BUILT-IN COMPONENTS ONLY:

WBOX92Z

pag 300

ELEMENT

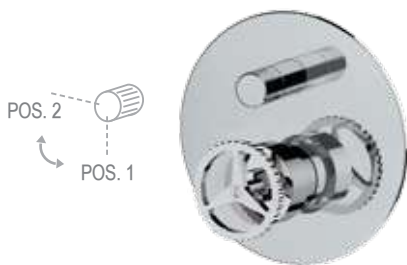

CH09HL

Miscelatore a incasso per vasca/doccia con deviatore a 2 vie a vitone ceramico. Per selezionare l'uscita desiderata, la manopola del deviatore deve essere ruotata da una posizione all'altra.
Built-in bath/shower mixer with 2-way diverter with ceramic head valve. To select the desired output, the diverter knob must be turned from one position to the other.

CR FIN 1 FIN 2

N09HB

Solo parte interna.
Built-in components only.



CH09LE

Solo parte esterna.
Exposed components only.

CR FIN 1 FIN 2 CR FIN 1 FIN 2



Q DESIGN

X-STYLE



2 VIE
WAYS



SOLO PARTE ESTERNA - EXPOSED COMPONENTS ONLY:

CH97D2PWB

Set miscelatore a incasso a 2 vie per vasca/doccia su 3 piastre tonde. Da completare con la seconda uscita.
2-way built-in shower mixer set on 3 round plates. To be completed with the second water outlet.

CR FIN 1 FIN 2

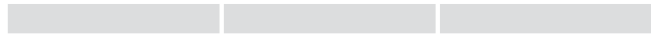

SOLO PARTE INTERNA - BUILT-IN COMPONENTS ONLY:

WBOX97D2

pag 304



SOLO PARTE ESTERNA - EXPOSED COMPONENTS ONLY:

CH97D2WB

Set miscelatore a incasso a 2 vie per vasca/doccia su piastra rettangolare. Da completare con la seconda uscita.
2-way built-in shower mixer set on rectangular plate. To be completed with the second water outlet.

CR FIN 1 FIN 2



SOLO PARTE INTERNA - BUILT-IN COMPONENTS ONLY:

WBOX97D2

pag 304



3 VIE
WAYS



SOLO PARTE ESTERNA - EXPOSED COMPONENTS ONLY:

CH93ZPWB

Miscelatore a incasso per vasca/doccia con deviatore a 3 vie di tipo meccanico, su due piastre tonde.
Built-in bath/shower mixer with 3-way mechanical diverter, on two round plates.

CR FIN 1 FIN 2



SOLO PARTE INTERNA - BUILT-IN COMPONENTS ONLY:

WBOX93Z

pag 302



SOLO PARTE ESTERNA - EXPOSED COMPONENTS ONLY:

CH93ZWB

Miscelatore a incasso per vasca/doccia con deviatore a 3 vie di tipo meccanico, su piastra rettangolare.
Built-in bath/shower mixer with 3-way mechanical diverter, on rectangular plate.

CR FIN 1 FIN 2



SOLO PARTE INTERNA - BUILT-IN COMPONENTS ONLY:

WBOX93Z

pag 302



3 VIE
WAYS



SOLO PARTE ESTERNA - EXPOSED COMPONENTS ONLY:

CH97D3PWB

Set miscelatore a incasso a 3 vie per vasca/doccia su 3 piastre tonde. Da completare con la seconda e la terza uscita acqua.
3-way built-in bath/shower mixer set on 3 round plates. To be completed with the second and the third water outlet.

CR FIN 1 FIN 2



SOLO PARTE INTERNA - BUILT-IN COMPONENTS ONLY:

WBOX97D3

pag 308



SOLO PARTE ESTERNA - EXPOSED COMPONENTS ONLY:

CH97D3WB

Set miscelatore a incasso a 3 vie per vasca/doccia su piastra rettangolare. Da completare con la seconda e la terza uscita acqua.
3-way built-in shower mixer set on rectangular plate. To be completed with the second and the third water outlet.

CR FIN 1 FIN 2

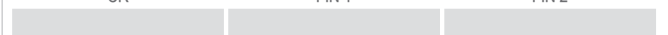

SOLO PARTE INTERNA - BUILT-IN COMPONENTS ONLY:

WBOX97D3

pag 308



ATELIER

CHRONO

CELEBRITY

ELEMENT

Q DESIGN

X-STYLE

MISCELATORI A 2/3/4/5 VIE CON VITONE CERAMICO
 2, 3, 4 OR 5-WAY MIXERS WITH CERAMIC HEADVALVE

SOLO PARTE ESTERNA - EXPOSED COMPONENTS ONLY:

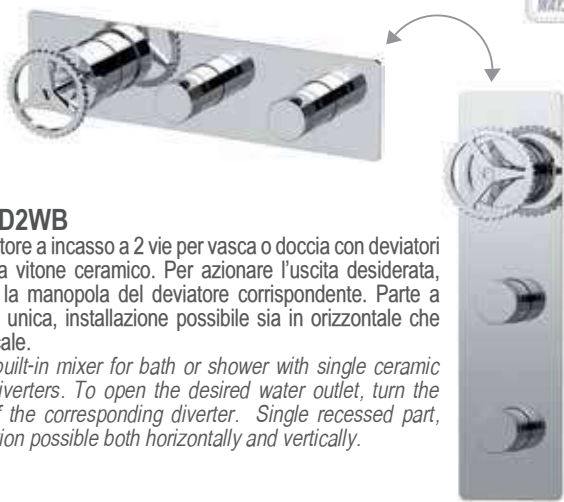

2 VIE
WAYS

CH98D2WB

Miscelatore a incasso a 2 vie per vasca o doccia con deviatori singoli a vitone ceramico. Per azionare l'uscita desiderata, ruotare la manopola del deviatore corrispondente. Parte a incasso unica, installazione possibile sia in orizzontale che in verticale.

2-way built-in mixer for bath or shower with single ceramic valve diverters. To open the desired water outlet, turn the knob of the corresponding diverter. Single recessed part, installation possible both horizontally and vertically.

CR

FIN 1

FIN 2

SOLO PARTE INTERNA - BUILT-IN COMPONENTS ONLY:

WBOX98D2

pag 313

SOLO PARTE ESTERNA - EXPOSED COMPONENTS ONLY:



2 VIE
WAYS

CH98D2PWB

Miscelatore a incasso a 2 vie per vasca o doccia con deviatori singoli a vitone ceramico. Per azionare l'uscita desiderata, ruotare la manopola del deviatore corrispondente. Parte a incasso unica, installazione possibile sia in orizzontale che in verticale.

2-way built-in mixer for bath or shower with single ceramic valve diverters. To open the desired water outlet, turn the knob of the corresponding diverter. Single recessed part, installation possible both horizontally and vertically.

CR

FIN 1

FIN 2

SOLO PARTE INTERNA - BUILT-IN COMPONENTS ONLY:

WBOX98D2

pag 313

SOLO PARTE ESTERNA - EXPOSED COMPONENTS ONLY:



3 VIE
WAYS

CH98D3WB

Miscelatore a incasso a 3 vie per vasca o doccia con deviatori singoli a vitone ceramico. Per azionare l'uscita desiderata, ruotare la manopola del deviatore corrispondente. Parte a incasso unica, installazione possibile sia in orizzontale che in verticale.

3-way built-in mixer for bath or shower with single ceramic valve diverters. To open the desired water outlet, turn the knob of the corresponding diverter. Single recessed part, installation possible both horizontally and vertically.

CR

FIN 1

FIN 2

SOLO PARTE INTERNA - BUILT-IN COMPONENTS ONLY:

WBOX98D3

pag 313

SOLO PARTE ESTERNA - EXPOSED COMPONENTS ONLY:

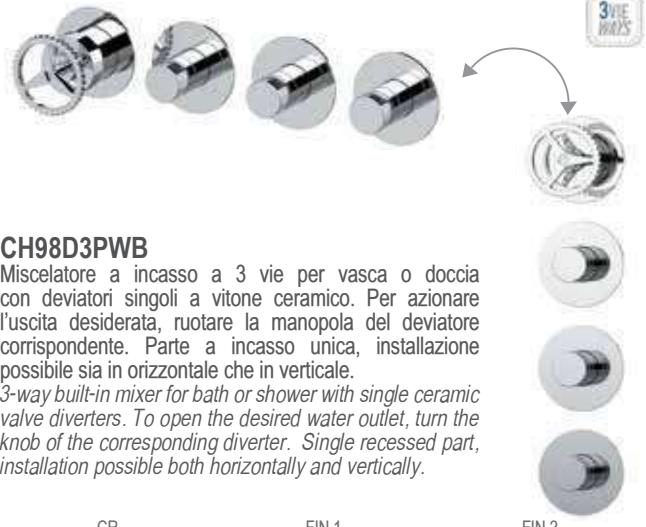

3 VIE
WAYS

CH98D3PWB

Miscelatore a incasso a 3 vie per vasca o doccia con deviatori singoli a vitone ceramico. Per azionare l'uscita desiderata, ruotare la manopola del deviatore corrispondente. Parte a incasso unica, installazione possibile sia in orizzontale che in verticale.

3-way built-in mixer for bath or shower with single ceramic valve diverters. To open the desired water outlet, turn the knob of the corresponding diverter. Single recessed part, installation possible both horizontally and vertically.

CR

FIN 1

FIN 2

SOLO PARTE INTERNA - BUILT-IN COMPONENTS ONLY:

WBOX98D3

pag 313

SOLO PARTE ESTERNA - EXPOSED COMPONENTS ONLY:

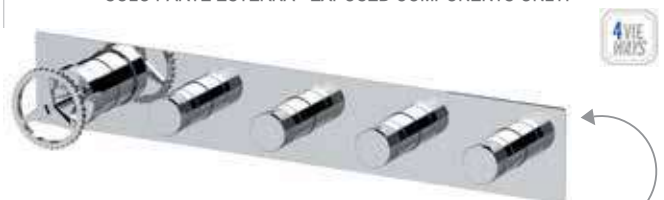

CH98D4WB

Miscelatore a incasso a 4 vie per vasca o doccia con deviatori singoli a vitone ceramico. Per azionare l'uscita desiderata, ruotare la manopola del deviatore corrispondente. Parte a incasso unica, installazione possibile sia in orizzontale che in verticale.

4-way built-in mixer for bath or shower with single ceramic valve diverters.

To open the desired water outlet, turn the knob of the corresponding diverter. Single recessed part, installation possible both horizontally and vertically.



CR FIN 1 FIN 2

SOLO PARTE ESTERNA - EXPOSED COMPONENTS ONLY:



CH98D4PWB

Miscelatore a incasso a 4 vie per vasca o doccia con deviatori singoli a vitone ceramico. Per azionare l'uscita desiderata, ruotare la manopola del deviatore corrispondente. Parte a incasso unica, installazione possibile sia in orizzontale che in verticale.

4-way built-in mixer for bath or shower with single ceramic valve diverters.

To open the desired water outlet, turn the knob of the corresponding diverter. Single recessed part, installation possible both horizontally and vertically.



CR FIN 1 FIN 2

SOLO PARTE INTERNA - BUILT-IN COMPONENTS ONLY:

WBOX98D4

> pag 314

SOLO PARTE INTERNA - BUILT-IN COMPONENTS ONLY:

WBOX98D4

> pag 314

SOLO PARTE ESTERNA - EXPOSED COMPONENTS ONLY:



CH98D5WB

Miscelatore a incasso a 5 vie per vasca o doccia con deviatori singoli a vitone ceramico. Per azionare l'uscita desiderata, ruotare la manopola del deviatore corrispondente. Parte a incasso unica, installazione possibile sia in orizzontale che in verticale.

5-way built-in mixer for bath or shower with single ceramic valve diverters. To open the desired water outlet, turn the knob of the corresponding diverter. Single recessed part, installation possible both horizontally and vertically.



CR FIN 1 FIN 2

SOLO PARTE ESTERNA - EXPOSED COMPONENTS ONLY:



CH98D5PWB

Miscelatore a incasso a 5 vie per vasca o doccia con deviatori singoli a vitone ceramico. Per azionare l'uscita desiderata, ruotare la manopola del deviatore corrispondente. Parte a incasso unica, installazione possibile sia in orizzontale che in verticale.

5-way built-in mixer for bath or shower with single ceramic valve diverters. To open the desired water outlet, turn the knob of the corresponding diverter. Single recessed part, installation possible both horizontally and vertically.



CR FIN 1 FIN 2

SOLO PARTE INTERNA - BUILT-IN COMPONENTS ONLY:

WBOX98D5

> pag 314

SOLO PARTE INTERNA - BUILT-IN COMPONENTS ONLY:

WBOX98D5

> pag 314

CELEBRITY

ICONA DI PERSONALIZZAZIONE
PERSONALIZATION ICON



CELEBRITY è una collezione di miscelatori monocomando dallo stile elegante e sofisticato. Un design senza tempo impreziosito dagli intarsi di 3 differenti modelli di maniglie. Cartuccia diametro 25mm, 35mm per le figure a incasso.

CELEBRITY is a collection of single-lever mixers with an elegant and sophisticated style. A timeless design enriched by the inlays of 3 different handle models. 25mm diameter cartridge, 35mm for the built-in items.



CELEBRITY

CELEBRITY

CEC08



CEC10ACC

ATELIER

CHRONO

CELEBRITY

ELEMENT

Q DESIGN

X-STYLE



CEC12RP



CEB10LXLXV - CED12BG - CEC12ARP

//////////////////// OPZIONI DI FINITURA - FINISHING OPTIONS //////////////////////

CR		FIN 1		FIN 2	
	cromo chrome		nero opaco matt black		cromo nero spazzolato brushed black chrome
	CR		bianco opaco matt white		oro spazzolato brushed gold
			visual inox visual steel		oro lucido shiny gold
			oil bronze oil bronze		rame spazzolato brushed copper
			NO		CFP
			BO		BG
			XV		DO
			BR		RP

LEVA / LEVER
CHESTER



LEVA / LEVER
DUNE



CELEBRITY

OPZIONE LEVA

La collezione è disponibile con tre varianti di maniglia, identificate dalle prime tre lettere del codice prodotto.

Indicare la preferenza al momento dell'ordine.

CELEBRITY

LEVER OPTION

This collection is available with three lever options, identified by the first three letters of the product code.

Show your preference when ordering.

LEVA / LEVER BOLD



MISCELATORI LAVABO - WASHBASIN MIXERS



CEC10
 Miscelatore monocomando per lavabo, con scarico.
Single-lever basin mixer, with pop-up waste.



CEC10ACC
 Miscelatore monocomando per lavabo, modello "A" altezza media, con scarico click-clack con troppo-pieno incluso.
Single-lever basin mixer, model "A" medium height, with click-clack waste and overflow.



CEC10LXL
 Miscelatore monocomando alto per lavabo, misura XL, scarico click-clack con troppo-pieno incluso.
High single-lever washbasin mixer, XL size, with "click-clack" waste and overflow.



CEC12
 Miscelatore monocomando per lavabo, senza scarico e senza foro posteriore sul corpo.
Single-lever basin mixer, without waste and without rear body hole.



CEC12A
 Miscelatore monocomando per lavabo, modello "A" altezza media, senza scarico e senza foro sul corpo.
Single-lever basin mixer, model "A" medium height, without pop-up waste and with no rear hole.



CEC11LXL
 Miscelatore monocomando alto per lavabo, misura XL, scarico non incluso.
High single-lever washbasin mixer, XL size, waste not included.



CEC57
 Miscelatore monocomando per lavabo a due fori. Scarico non incluso.
2-holes single-lever basin mixer. Waste not included.



CEC57L
 Miscelatore monocomando per lavabo a due fori, con bocca L. Scarico non incluso.
2-holes single-lever basin mixer, with L spout. Waste not included.



CEC15P
 Miscelatore monocomando a incasso per lavabo, su due piastre tonde separate. Lunghezza bocca 17 cm.
Built-in single-lever basin mixer with two separate round plates. Spout length 17 cm.





CEC18

Miscelatore monocomando da pavimento per lavabo, scarico click-clack con troppo-pieno incluso. Prodotto completo.
Floor mounting single-lever basin mixer, click-clack waste with overflow included. Complete product.



Q08FIS2

Solo parte interna.
Built-in components only.



CEC18E

Solo parti esterne.
Exposed components only.

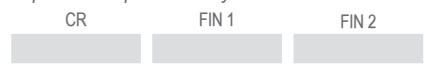

CEC15

Miscelatore monocomando a incasso per lavabo. Piastra ultra-piatta. Lunghezza bocca 17 cm.
Single-lever built-it basin mixer. Ultra-flat plate. Spout length 17 cm.



CEC15L

Miscelatore monocomando a incasso per lavabo. Piastra ultra-piatta. Lunghezza bocca 19 cm.
Single-lever built-it basin mixer. Ultra-flat plate. Spout length 19 cm.

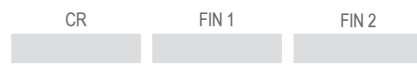

BOCCHIE - SPOUTS



CEC15PL

Miscelatore monocomando a incasso per lavabo, su due piastre tonde separate. Lunghezza bocca 19 cm.
Built-in single-lever basin mixer with two separate round plates. Spout length 19 cm.

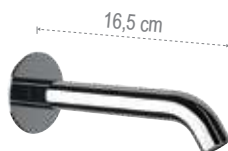

91X

Bocca incasso per miscelatore vasca/doccia.
Built-in spout for bath/shower mixer.

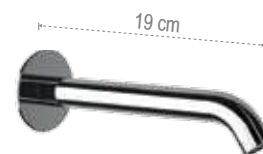

91XL

Bocca incasso per miscelatore vasca/doccia, 19cm
Built-in spout for bath/shower mixer, 19cm



LAVABO A MURO CON BOX INCASSO - WALL WASHBASIN MIXER WITH BUILT-IN BOX



SOLO PARTE ESTERNA - EXPOSED COMPONENTS ONLY:

CEC15WB

Parti esterne per miscelatore monocomando a incasso per lavabo da abbinare al box incasso (non incluso). Piastra ultra-piatta. Lunghezza bocca 17 cm.
Exposed components for single-lever built-in basin mixer, with ultra-flat wall plate. To match with the built-in box (not included). Spout length 17 cm.

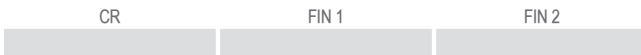

CEC15LWB

Idem sopra, con lunghezza bocca 19 cm.
Same as above, with spout length 19 cm.

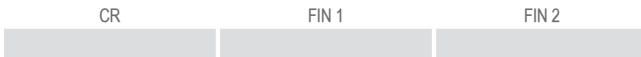

SOLO PARTE INTERNA - BUILT-IN COMPONENTS ONLY:

WBOX15



SOLO PARTE ESTERNA - EXPOSED COMPONENTS ONLY:

CEC15PWB

Parti esterne per miscelatore monocomando a incasso per lavabo da abbinare al box incasso (non incluso). Su due piastre tonde separate. Lunghezza bocca 17 cm.

Exposed components for single-lever built-in basin mixer, with two separate round plates. To match with the built-in box (not included). Spout length 17 cm.



CEC15PLWB

Idem sopra, con lunghezza bocca 19 cm.
Same as above, with spout length 19 cm.

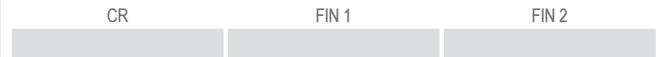

SOLO PARTE INTERNA - BUILT-IN COMPONENTS ONLY:

WBOX15



CEB15PNO

MISCELATORI BIDET - BIDET MIXERS

**CEC20**

Miscelatore monocomando per bidet, con scarico.
Single-lever bidet mixer, with pop-up waste.

CR FIN 1 FIN 2

**CEC22**

Miscelatore monocomando per bidet, senza scarico e senza foro posteriore sul corpo.
Single-lever bidet mixer, without waste and without rear body hole.

CR FIN 1 FIN 2

**CEC65W**

Set shut-off comprensivo di: miscelatore a incasso con supporto doccia/presa acqua, doccetta a pulsante(332OW), tutto in ottone. Flessibile doccia cm 120.

Shut-off set including: built-in mixer with shower holder/water punch on plate, shut-off hand shower (332OW), all in brass. Flexible hose cm 120.

CR FIN 1 FIN 2

MISCELATORI ESTERNI PER VASCA E DOCCIA - EXPOSED MIXERS FOR BATH AND SHOWER

**CEC02**

Miscelatore monocomando per vasca, con kit doccetta in ottone ad 1 funzione. Prodotto completo. 150cm.

Wall mounted single-lever bath mixer with 1-function brass hand shower kit. 150cm flexible hose.

CR FIN 1 FIN 2

**CEC05**

Miscelatore monocomando per vasca, senza doccia.

Wall mounted single-lever bath mixer, without shower kit.

CR FIN 1 FIN 2

**CEC08**

Miscelatore bordo vasca da pavimento, con deviatore e kit doccetta in ottone. Prodotto completo.

Floor mounting single-lever bath mixer, with diverter and brass hand shower kit. Complete product.

CR FIN 1 FIN 2

Q08FIS2

Solo parte interna.
Built-in components only.

CR

CEC08E

Solo parte esterna.
Exposed components only.

CR FIN 1 FIN 2

MISCELATORI A INCASSO PER VASCA - BUILT-IN MIXERS FOR BATH



SOLO PARTE ESTERNA - EXPOSED COMPONENTS ONLY:

CEC53D2PWB

Set a incasso a 2 vie per vasca su piastre tonde separate.
2-way built-in set for bathtub on separate round plates.

CR FIN 1 FIN 2

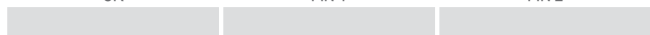

SOLO PARTE INTERNA - BUILT-IN COMPONENTS ONLY:

WBOX97D2

pag 304



SOLO PARTE ESTERNA - EXPOSED COMPONENTS ONLY:

CEC53D2WB

Set a incasso a 2 vie per vasca su piastra unica rettangolare.
2-way built-in set for bathtub on a single rectangular plate.

CR FIN 1 FIN 2

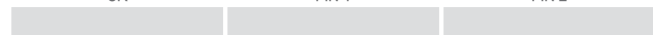

SOLO PARTE INTERNA - BUILT-IN COMPONENTS ONLY:

WBOX97D2

pag 304



SOLO PARTE ESTERNA - EXPOSED COMPONENTS ONLY:

CEC54D2PWB

Set miscelatore a incasso a 2 vie per vasca/doccia su 3 piastre tonde. Da completare con la seconda uscita acqua.
2-way built-in mixer set for bathtub / shower on 3 round plates. To be completed with the second water outlet.

CR FIN 1 FIN 2

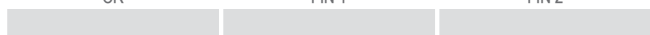

SOLO PARTE INTERNA - BUILT-IN COMPONENTS ONLY:

WBOX97D2

pag 304



SOLO PARTE ESTERNA - EXPOSED COMPONENTS ONLY:

CEC54D2WB

Set miscelatore a incasso a 2 vie per vasca/doccia su piastra unica rettangolare. Da completare con la seconda uscita.
2-way built-in mixer set for bathtub / shower on single rectangular plate. To be completed with the second water outlet.

CR FIN 1 FIN 2



SOLO PARTE INTERNA - BUILT-IN COMPONENTS ONLY:

WBOX97D2

pag 304



SOLO PARTE ESTERNA - EXPOSED COMPONENTS ONLY:

CEC54D3PWB

Set miscelatore a incasso a 3 vie per vasca/doccia su 3 piastre tonde. Da completare con la seconda e la terza uscita acqua.
3-way built-in mixer set for bathtub / shower on 3 separate round plates. To be completed with the second and the third water outlet.

CR FIN 1 FIN 2

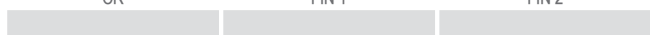

SOLO PARTE INTERNA - BUILT-IN COMPONENTS ONLY:

WBOX97D3

pag 308



SOLO PARTE ESTERNA - EXPOSED COMPONENTS ONLY:

CEC54D3WB

Set miscelatore a incasso a 3 vie per vasca/doccia su piastra unica rettangolare. Da completare con la seconda e la terza uscita acqua.
3-way built-in mixer set for bathtub / shower on single rectangular plate. To be completed with the second and the third water outlet.

CR FIN 1 FIN 2



SOLO PARTE INTERNA - BUILT-IN COMPONENTS ONLY:

WBOX97D3

pag 308

Set doccia acquistabile separatamente a pagina 427 - Shower set can be purchased separately on page 427

MISCELATORI A INCASSO PER DOCCIA - BUILT-IN MIXERS FOR SHOWER

ATELIER



CEC30L

Miscelatore a incasso per doccia, su piastra tonda ultra-piatta.
Built-in shower mixer, ultra-flat round wall plate.



CEC30Q

Miscelatore a incasso per doccia, su piastra quadrata ultra-piatta.
Built-in shower mixer, ultra-flat square wall plate.



CHRONO



CEC09L

Miscelatore a incasso per vasca/doccia con deviatore a pressione, su piastra tonda ultra-piatta.
Built-in bath/shower mixer with push button diverter, on ultra-flat round wall plate.



CEC09Q

Miscelatore a incasso per vasca/doccia con deviatore a pressione, su piastra quadrata ultra-piatta.
Built-in bath/shower mixer with push button diverter, on ultra-flat square wall plate.



CELEBRITY

N09B

Solo parte interna.
Built-in components only.



CEC09LE

Solo parte esterna.
Exposed components only.



N09B

Solo parte interna.
Built-in components only.



CEC09QE

Solo parte esterna.
Exposed components only.



ELEMENT

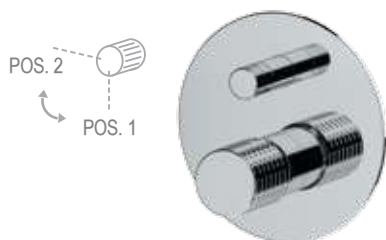

CEC09HL

Miscelatore a incasso per vasca/doccia con deviatore a 2 vie a vitone ceramico. Per selezionare l'uscita desiderata, la manopola del deviatore deve essere ruotata da una posizione all'altra.
Built-in bath/shower mixer with 2-way diverter with ceramic head valve. To select the desired output, the diverter knob must be turned from one position to the other.

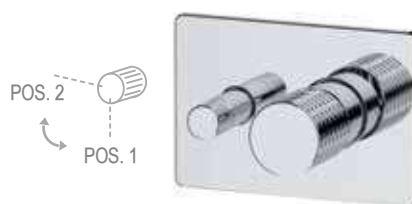

CEC09HRG

Miscelatore a incasso per vasca/doccia con deviatore a 2 vie con vitone ceramico, su piastra rettangolare, installazione orizzontale. Per selezionare l'uscita desiderata, la manopola del deviatore deve essere ruotata da una posizione all'altra.
Built-in bath/shower mixer with 2-way diverter with ceramic head valve, on rectangular plate, horizontal mounting. To select the desired output, the diverter knob must be turned from one position to the other.



Q DESIGN

N09HB

Solo parte interna.
Built-in components only.



CEC09LE

Solo parte esterna.
Exposed components only.



N09HRB

Solo parte interna.
Built-in components only.



CEC09GE

Solo parte esterna.
Exposed components only.



X-STYLE



SOLO PARTE ESTERNA - EXPOSED COMPONENTS ONLY:

CEC92ZPWB

Miscelatore a incasso per vasca/doccia con deviatore a 2 vie di tipo meccanico, su due piastre tonde.
Built-in bath/shower mixer with 2-way mechanical diverter, on two round plates.

CR FIN 1 FIN 2



SOLO PARTE INTERNA - BUILT-IN COMPONENTS ONLY:

WBOX92Z

pag 300

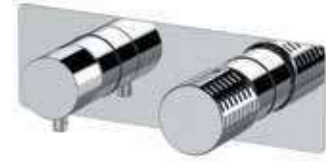

SOLO PARTE ESTERNA - EXPOSED COMPONENTS ONLY:

CEC92ZWB

Miscelatore a incasso per vasca/doccia con deviatore a 2 vie di tipo meccanico, su piastra rettangolare.
Built-in bath/shower mixer with 2-way mechanical diverter, on rectangular plate.

CR FIN 1 FIN 2



SOLO PARTE INTERNA - BUILT-IN COMPONENTS ONLY:

WBOX92Z

pag 300



SOLO PARTE ESTERNA - EXPOSED COMPONENTS ONLY:

CEC97D2PWB

Set miscelatore a incasso a 2 vie per vasca/doccia su 3 piastre tonde. Da completare con la seconda uscita.
2-way built-in shower mixer set on 3 round plates. To be completed with the second water outlet.

CR FIN 1 FIN 2



SOLO PARTE INTERNA - BUILT-IN COMPONENTS ONLY:

WBOX97D2

pag 304



SOLO PARTE ESTERNA - EXPOSED COMPONENTS ONLY:

CEC97D2WB

Set miscelatore a incasso a 2 vie per vasca/doccia su piastra rettangolare. Da completare con la seconda uscita.
2-way built-in shower mixer set on rectangular plate. To be completed with the second water outlet.

CR FIN 1 FIN 2



SOLO PARTE INTERNA - BUILT-IN COMPONENTS ONLY:

WBOX97D2

pag 304



SOLO PARTE ESTERNA - EXPOSED COMPONENTS ONLY:

CEC93ZPWB

Miscelatore a incasso per vasca/doccia con deviatore a 3 vie di tipo meccanico, su due piastre tonde.
Built-in bath/shower mixer with 3-way mechanical diverter, on two round plates

CR FIN 1 FIN 2

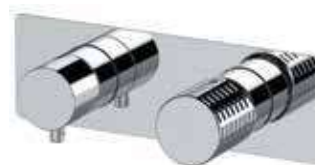

SOLO PARTE ESTERNA - EXPOSED COMPONENTS ONLY:

CEC93ZWB

Miscelatore a incasso per vasca/doccia con deviatore a 3 vie di tipo meccanico, su piastra rettangolare.
Built-in bath/shower mixer with 3-way mechanical diverter, on rectangular plate.

CR FIN 1 FIN 2

SOLO PARTE INTERNA - BUILT-IN COMPONENTS ONLY:

WBOX93Z

pag 302

SOLO PARTE INTERNA - BUILT-IN COMPONENTS ONLY:

WBOX93Z

pag 302



SOLO PARTE ESTERNA - EXPOSED COMPONENTS ONLY:

CEC97D3PWB

Set miscelatore a incasso a 3 vie per vasca/doccia su 3 piastre tonde. Da completare con la seconda e la terza uscita acqua.
3-way built-in bath/shower mixer set on 3 round plates. To be completed with the second and the third water outlet.

CR FIN 1 FIN 2



SOLO PARTE ESTERNA - EXPOSED COMPONENTS ONLY:

CEC97D3WB

Set miscelatore a incasso a 3 vie per vasca/doccia su piastra rettangolare. Da completare con la seconda e la terza uscita acqua.
3-way built-in shower mixer set on rectangular plate. To be completed with the second and the third water outlet.

CR FIN 1 FIN 2

SOLO PARTE INTERNA - BUILT-IN COMPONENTS ONLY:

WBOX97D3

pag 308

SOLO PARTE INTERNA - BUILT-IN COMPONENTS ONLY:

WBOX97D3

pag 308

ELEMENT

L'ARMONIA DELLA MATERIA

THE HARMONY OF SUBSTANCE



La collezione di rubinetteria ELEMENT esprime un'eleganza moderna data dall'essenzialità delle forme e dalla particolarità dell'impugnatura di miscelazione. L'assenza di tagli posteriori sulla leva e la basetta spessa con doppia inclinazione contribuiscono all'equilibrio estetico dell'intera figura. Cartuccia a dischi ceramici Ø 35 mm.

The ELEMENT faucet collection expresses a modern elegance given by the essentiality of the shapes and by the peculiarity of the mixing handle. The absence of back cuts on the lever and the thick base with double inclination contribute to the aesthetic balance of the whole figure. Ceramic disc cartridge Ø 35 mm.





ET08



ET10LXL



ET08CFP



ET57LCFP

//////////////////////////////////// OPZIONI DI FINITURA - FINISHING OPTIONS //////////////////////////////////////

CR		FIN 1		FIN 2	
	cromo chrome		nero opaco matt black		cromo nero spazzolato brushed black chrome
	CR		bianco opaco matt white		oro spazzolato brushed gold
			visual inox visual steel		oro lucido shiny gold
			oil bronze oil bronze		rame spazzolato brushed copper
			NO		CFP
			BO		BG
			XV		DO
			BR		RP

MISCELATORI LAVABO - WASHBASIN MIXERS



ET10
 Miscelatore monocomando per lavabo, con scarico.
Single-lever basin mixer, with pop-up waste.

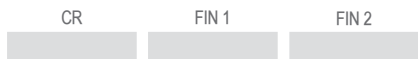

ET10ACC
 Miscelatore monocomando per lavabo, modello "A" altezza media, con scarico click-clack con troppo-pieno incluso.
Single-lever basin mixer, model "A" medium height, with click-clack waste and overflow.



ET10LXL
 Miscelatore monocomando alto per lavabo, scarico click-clack con troppo-pieno incluso.
High single-lever basin mixer, click-clack waste with overflow included.

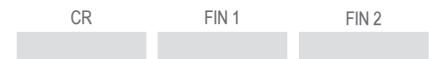

ET12
 Miscelatore monocomando per lavabo, senza scarico e senza foro posteriore sul corpo.
Single-lever basin mixer, without waste and without rear body hole.



ET12A
 Miscelatore monocomando per lavabo, modello "A" altezza media, senza scarico e senza foro sul corpo.
Single-lever basin mixer, model "A" medium height, without pop-up waste and with no rear hole.



ET11LXL
 Miscelatore monocomando alto per lavabo, senza scarico.
High single-lever basin mixer, without waste.



BOCCE - SPOUTS



ET57
 Miscelatore monocomando per lavabo a due fori. Scarico non incluso.
2-holes single-lever basin mixer. Waste not included.



ET57L
 Miscelatore monocomando per lavabo a due fori, con bocca L. Scarico non incluso.
2-holes single-lever basin mixer, with L spout. Waste not included.

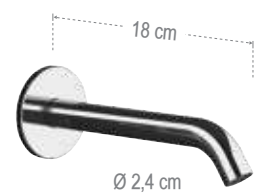

91ET
 Bocca incasso per miscelatore vasca/doccia.
Built-in spout for bath/shower mixer.





ET10ACCBG

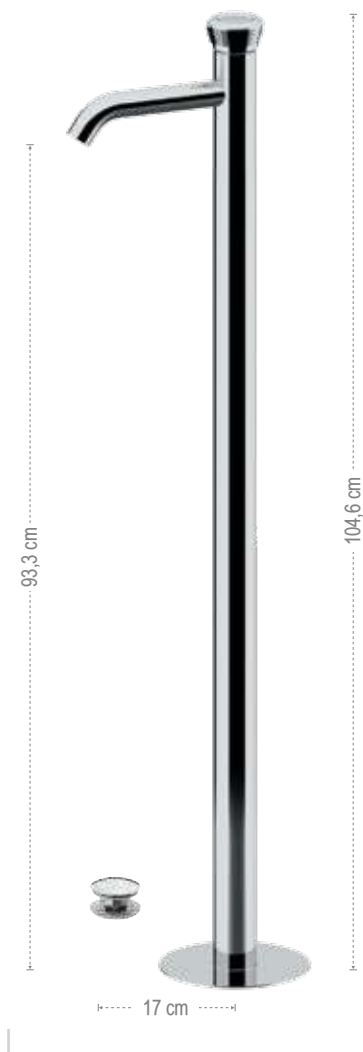

ET18

Miscelatore monocomando da pavimento per lavabo, scarico click-clack con troppo-pieno incluso. Prodotto completo.

Floor mounting single-lever basin mixer, click-clack waste with overflow included. Complete product.

CR FIN 1 FIN 2

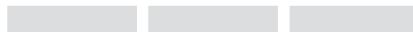

Q08FIS2

Solo parte interna.
Built-in components only.



CR

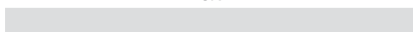

ET18E

Solo parti esterne.
Exposed components only.

CR FIN 1 FIN 2

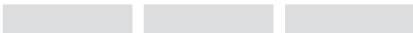

ET15

Miscelatore monocomando a incasso per lavabo. Piastra ultra-piatta. Lunghezza bocca 18 cm.
Single-lever built-in basin mixer. Ultra-flat plate. Spout length 18 cm.

CR FIN 1 FIN 2

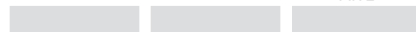

ET15P

Miscelatore monocomando a incasso per lavabo, su due piastre tonde separate. Lunghezza bocca 18 cm.
Built-in single-lever basin mixer with two separate round plates. Spout length 18 cm.

CR FIN 1 FIN 2

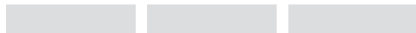

LAVABO A MURO CON BOX INCASSO - WALL WASHBASIN MIXER WITH BUILT-IN BOX



SOLO PARTE ESTERNA - EXPOSED COMPONENTS ONLY:

ET15WB

Parti esterne per miscelatore monocomando a incasso per lavabo da abbinare al box incasso (non incluso). Piastra ultra-piatta. Lunghezza bocca 18 cm.
Exposed components for single-lever built-in basin mixer, with ultra-flat wall plate. To match with the built-in box (not included). Spout length 18 cm.

CR FIN 1 FIN 2

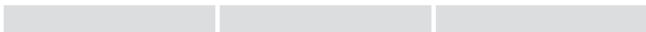

SOLO PARTE ESTERNA - EXPOSED COMPONENTS ONLY:

ET15PWB

Parti esterne per miscelatore monocomando a incasso per lavabo da abbinare al box incasso (non incluso). Su due piastre tonde separate. Lunghezza bocca 18 cm.
Exposed components for single-lever built-in basin mixer, with two separate round plates. To match with the built-in box (not included). Spout length 18 cm.

CR FIN 1 FIN 2

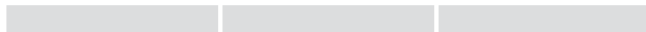

SOLO PARTE INTERNA - BUILT-IN COMPONENTS ONLY:

WBOX15

SOLO PARTE INTERNA - BUILT-IN COMPONENTS ONLY:

WBOX15

MISCELATORI BIDET - *BIDET MIXERS***ET20**

Miscelatore monocomando per bidet, con scarico.
Single-lever bidet mixer, with pop-up waste.



CR FIN 1 FIN 2

**ET22**

Miscelatore monocomando per bidet, senza scarico e senza foro posteriore sul corpo.
Single-lever bidet mixer, without waste and without rear body hole.



CR FIN 1 FIN 2

**ET65**

Set shut-off comprensivo di: miscelatore a incasso con supporto doccia/presa acqua, doccetta a pulsante, tutto in ottone. Flessibile doccia cm 120.
"Shut-off set including: built-in mixer with shower holder/water punch on flange, shut-off hand shower, all in brass. Flexible hose cm 120".

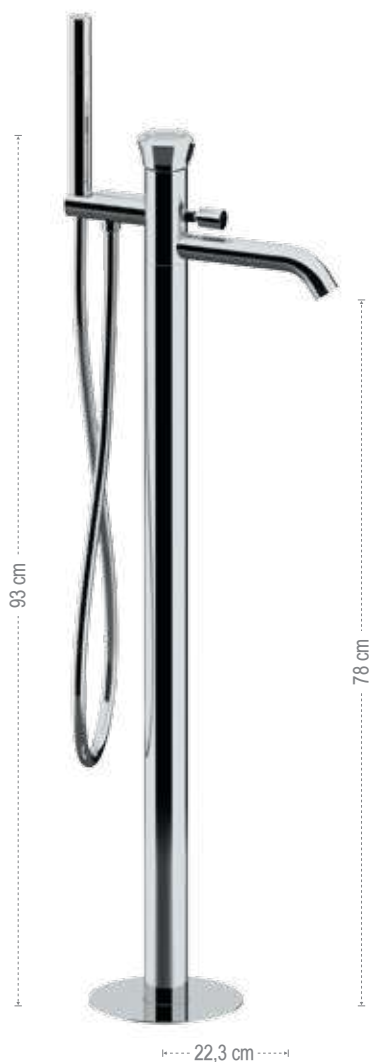

CR FIN 1 FIN 2

MISCELATORI ESTERNI PER VASCA E DOCCIA - *EXPOSED MIXERS FOR BATH AND SHOWER***ET08**

Miscelatore bordo vasca da pavimento, con deviatore e kit doccetta in ottone. Prodotto completo.

Floor mounting single-lever bath mixer, with diverter and brass hand shower kit. Complete product.

CR FIN 1 FIN 2

**ET02**

Miscelatore monocomando per vasca, con kit doccetta in ottone ad 1 funzione. Flessibile 150cm.
Wall mounted single-lever bath mixer with 1-function brass hand shower kit. 150cm flexible hose.

CR FIN 1 FIN 2

Q08FIS2

Solo parte interna.
Built-in components only.



CR

ET08E

Solo parti esterne.
Exposed components only.

CR FIN 1 FIN 2

**ET05**

Miscelatore monocomando per vasca, senza kit doccia.
Wall mounted single-lever bath mixer, without shower kit.

CR FIN 1 FIN 2

MISCELATORI A INCASSO PER VASCA - BUILT-IN MIXERS FOR BATH

2 VIE
WAYS

SOLO PARTE ESTERNA - EXPOSED COMPONENTS ONLY:

ET53D2WB

Set a incasso a 2 vie per vasca su piastra unica rettangolare.
2-way built-in set for bathtub on a single rectangular plate.

CR FIN 1 FIN 2

SOLO PARTE INTERNA - BUILT-IN COMPONENTS ONLY:

WBOX97D2

pag 304



SOLO PARTE ESTERNA - EXPOSED COMPONENTS ONLY:

ET53D2PWB

Set a incasso a 2 vie per vasca su piastre tonde separate.
2-way built-in set for bathtub on separate round plates.

CR FIN 1 FIN 2

SOLO PARTE INTERNA - BUILT-IN COMPONENTS ONLY:

WBOX97D2

pag 304

2 VIE
WAYS

SOLO PARTE ESTERNA - EXPOSED COMPONENTS ONLY:

ET54D2WB

Set miscelatore a incasso a 2 vie per vasca/doccia su piastra unica rettangolare. Da completare con la seconda uscita.
2-way built-in mixer set for bathtub / shower on single rectangular plate. To be completed with the second water outlet.

CR FIN 1 FIN 2

SOLO PARTE INTERNA - BUILT-IN COMPONENTS ONLY:

WBOX97D2

pag 304



SOLO PARTE ESTERNA - EXPOSED COMPONENTS ONLY:

ET54D2PWB

Set miscelatore a incasso a 2 vie per vasca/doccia su 3 piastre tonde. Da completare con la seconda uscita acqua.
2-way built-in mixer set for bathtub / shower on 3 round plates. To be completed with the second water outlet.

CR FIN 1 FIN 2

SOLO PARTE INTERNA - BUILT-IN COMPONENTS ONLY:

WBOX97D2

pag 304

3 VIE
WAYS

SOLO PARTE ESTERNA - EXPOSED COMPONENTS ONLY:

ET54D3WB

Set miscelatore a incasso a 3 vie per vasca/doccia su piastra unica rettangolare. Da completare con la seconda e la terza uscita acqua.
3-way built-in mixer set for bathtub / shower on single rectangular plate. To be completed with the second and the third water outlet.

CR FIN 1 FIN 2

SOLO PARTE INTERNA - BUILT-IN COMPONENTS ONLY:

WBOX97D3

pag 308



SOLO PARTE ESTERNA - EXPOSED COMPONENTS ONLY:

ET54D3PWB

Set miscelatore a incasso a 3 vie per vasca/doccia su 3 piastre tonde. Da completare con la seconda e la terza uscita acqua.
3-way built-in mixer set for bathtub / shower on 3 separate round plates. To be completed with the second and the third water outlet.

CR FIN 1 FIN 2

SOLO PARTE INTERNA - BUILT-IN COMPONENTS ONLY:

WBOX97D3

pag 308

Set doccia acquistabile separatamente a pagina 427 - Shower set can be purchased separately on page 427

MISCELATORI A INCASSO PER DOCCIA - BUILT-IN MIXERS FOR SHOWER

ATELIER



ET30L

Miscelatore a incasso per doccia, su piastra tonda ultra-piatta.
Built-in shower mixer, ultra-flat round wall plate.

CR	FIN 1	FIN 2
----	-------	-------



ET30Q

Miscelatore a incasso per doccia, su piastra quadrata ultra-piatta.
Built-in shower mixer, ultra-flat square wall plate.

CR	FIN 1	FIN 2
----	-------	-------

CHRONO



ET09L

Miscelatore a incasso per vasca/doccia con deviatore a pressione, su piastra tonda ultra-piatta.
Built-in bath/shower mixer with push button diverter, on ultra-flat round wall plate.

CR	FIN 1	FIN 2
----	-------	-------



ET09Q

Miscelatore a incasso per vasca/doccia con deviatore a pressione, su piastra quadrata ultra-piatta.
Built-in bath/shower mixer with push button diverter, on ultra-flat square wall plate.

CR	FIN 1	FIN 2
----	-------	-------

CELEBRITY

N09B

Solo parte interna.
Built-in components only.

CR	FIN 1	FIN 2
----	-------	-------



ET09LE

Solo parte esterna.
Exposed components only.

CR	FIN 1	FIN 2
----	-------	-------

N09B

Solo parte interna.
Built-in components only.

CR	FIN 1	FIN 2
----	-------	-------



ET09QE

Solo parte esterna.
Exposed components only.

CR	FIN 1	FIN 2
----	-------	-------

ELEMENT

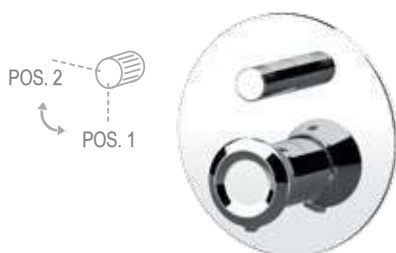

ET09HL

Miscelatore a incasso per vasca/doccia con deviatore a 2 vie a vitone ceramico. Per selezionare l'uscita desiderata, la manopola del deviatore deve essere ruotata da una posizione all'altra.
Built-in bath/shower mixer with 2-way diverter with ceramic head valve. To select the desired output, the diverter knob must be turned from one position to the other.

CR	FIN 1	FIN 2
----	-------	-------



ET09HRG

Miscelatore a incasso per vasca/doccia con deviatore a 2 vie con vitone ceramico, su piastra rettangolare, montaggio orizzontale. Per selezionare l'uscita desiderata, la manopola del deviatore deve essere ruotata da una posizione all'altra.
Built-in bath/shower mixer with 2-way diverter with ceramic head valve, on rectangular plate, horizontal mounting. To select the desired output, the diverter knob must be turned from one position to the other.

CR	FIN 1	FIN 2
----	-------	-------

Q DESIGN

N09HB

Solo parte interna.
Built-in components only.

CR	FIN 1	FIN 2
----	-------	-------



ET09LE

Solo parte esterna.
Exposed components only.

CR	FIN 1	FIN 2
----	-------	-------

N09HRB

Solo parte interna.
Built-in components only.

CR	FIN 1	FIN 2
----	-------	-------



ET09GE

Solo parte esterna.
Exposed components only.

CR	FIN 1	FIN 2
----	-------	-------

X-STYLE

2 VIE
WAYS



SOLO PARTE ESTERNA - EXPOSED COMPONENTS ONLY:

ET92ZWB

Miscelatore a incasso per vasca/doccia con deviatore a 2 vie di tipo meccanico, su piastra rettangolare.
Built-in bath/shower mixer with 2-way mechanical diverter, on rectangular plate.

CR FIN 1 FIN 2

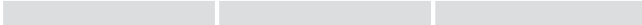

SOLO PARTE INTERNA - BUILT-IN COMPONENTS ONLY:

WBOX92Z

> pag 300



SOLO PARTE ESTERNA - EXPOSED COMPONENTS ONLY:

ET92ZPW

Miscelatore a incasso per vasca/doccia con deviatore a 2 vie di tipo meccanico, su due piastre tonde.
Built-in bath/shower mixer with 2-way mechanical diverter, on two round plates.

CR FIN 1 FIN 2

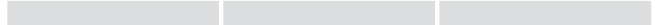

SOLO PARTE INTERNA - BUILT-IN COMPONENTS ONLY:

WBOX92Z

> pag 300

2 VIE
WAYS



SOLO PARTE ESTERNA - EXPOSED COMPONENTS ONLY:

ET97D2PWB

Set miscelatore a incasso a 2 vie per vasca/doccia su 3 piastre tonde. Da completare con la seconda uscita.
2-way built-in shower mixer set on 3 round plates. To be completed with the second water outlet.

CR FIN 1 FIN 2

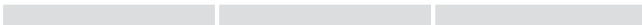

SOLO PARTE INTERNA - BUILT-IN COMPONENTS ONLY:

WBOX97D2

> pag 304



SOLO PARTE ESTERNA - EXPOSED COMPONENTS ONLY:

ET97D2WB

Set miscelatore a incasso a 2 vie per vasca/doccia su piastra rettangolare. Da completare con la seconda uscita.
2-way built-in shower mixer set on rectangular plate. To be completed with the second water outlet.

CR FIN 1 FIN 2

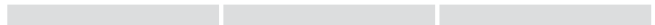

SOLO PARTE INTERNA - BUILT-IN COMPONENTS ONLY:

WBOX97D2

> pag 304



SOLO PARTE ESTERNA - EXPOSED COMPONENTS ONLY:

ET93ZWB

Miscelatore a incasso per vasca/doccia con deviatore a 3 vie di tipo meccanico, su piastra rettangolare.
Built-in bath/shower mixer with 3-way mechanical diverter, on rectangular plate.

CR FIN 1 FIN 2

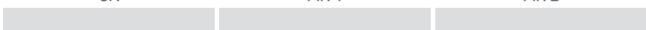

SOLO PARTE INTERNA - BUILT-IN COMPONENTS ONLY:

WBOX93Z

> pag 302



SOLO PARTE ESTERNA - EXPOSED COMPONENTS ONLY:

ET93ZPWB

Miscelatore a incasso per vasca/doccia con deviatore a 3 vie di tipo meccanico, su due piastre tonde.
Built-in bath/shower mixer with 3-way mechanical diverter, on two round plates.

CR FIN 1 FIN 2

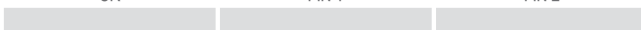

SOLO PARTE INTERNA - BUILT-IN COMPONENTS ONLY:

WBOX93Z

> pag 302



SOLO PARTE ESTERNA - EXPOSED COMPONENTS ONLY:

ET97D3PWB

Set miscelatore a incasso a 3 vie per vasca/doccia su 3 piastre tonde. Da completare con la seconda e la terza uscita acqua.
3-way built-in bath/shower mixer set on 3 round plates. To be completed with the second and the third water outlet.

CR FIN 1 FIN 2

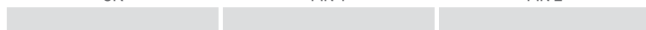

SOLO PARTE INTERNA - BUILT-IN COMPONENTS ONLY:

WBOX97D3

> pag 308



SOLO PARTE ESTERNA - EXPOSED COMPONENTS ONLY:

ET97D3WB

Set miscelatore a incasso a 3 vie per vasca/doccia su piastra rettangolare. Da completare con la seconda e la terza uscita acqua.
3-way built-in shower mixer set on rectangular plate. To be completed with the second and the third water outlet.

CR FIN 1 FIN 2

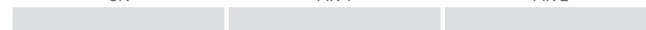

SOLO PARTE INTERNA - BUILT-IN COMPONENTS ONLY:

WBOX97D3

> pag 308

Q DESIGN

MINIMALISMO GEOMETRICO E POTENZA VISIVA
GEOMETRIC MINIMALISM AND VISUAL POWER



Q-DESIGN è una collezione di rubinetteria monocomando caratterizzata da un design totalmente squadrato e da un forte impatto moderno. La base quadrata del miscelatore si sviluppa intorno a una cartuccia dal diametro di 25 mm e si interseca a bocca e leva rettangolari di spessore minimo. La collezione dispone di numerose soluzioni sia da appoggio che da parete per inserirsi con naturale eleganza in ogni progetto d'arredo.

Q-DESIGN is a single-lever faucet collection characterized by a totally squared design and by a strong modern impact. The square base of the mixer is developed on a cartridge with a diameter of 25 mm and is intersected by rectangular spout and lever of minimum thickness. The collection has numerous solutions both as stand and built-in to naturally fit into any furnishing project.



Q DESIGN



Q DESIGN



QD53D2WB



QD18DO

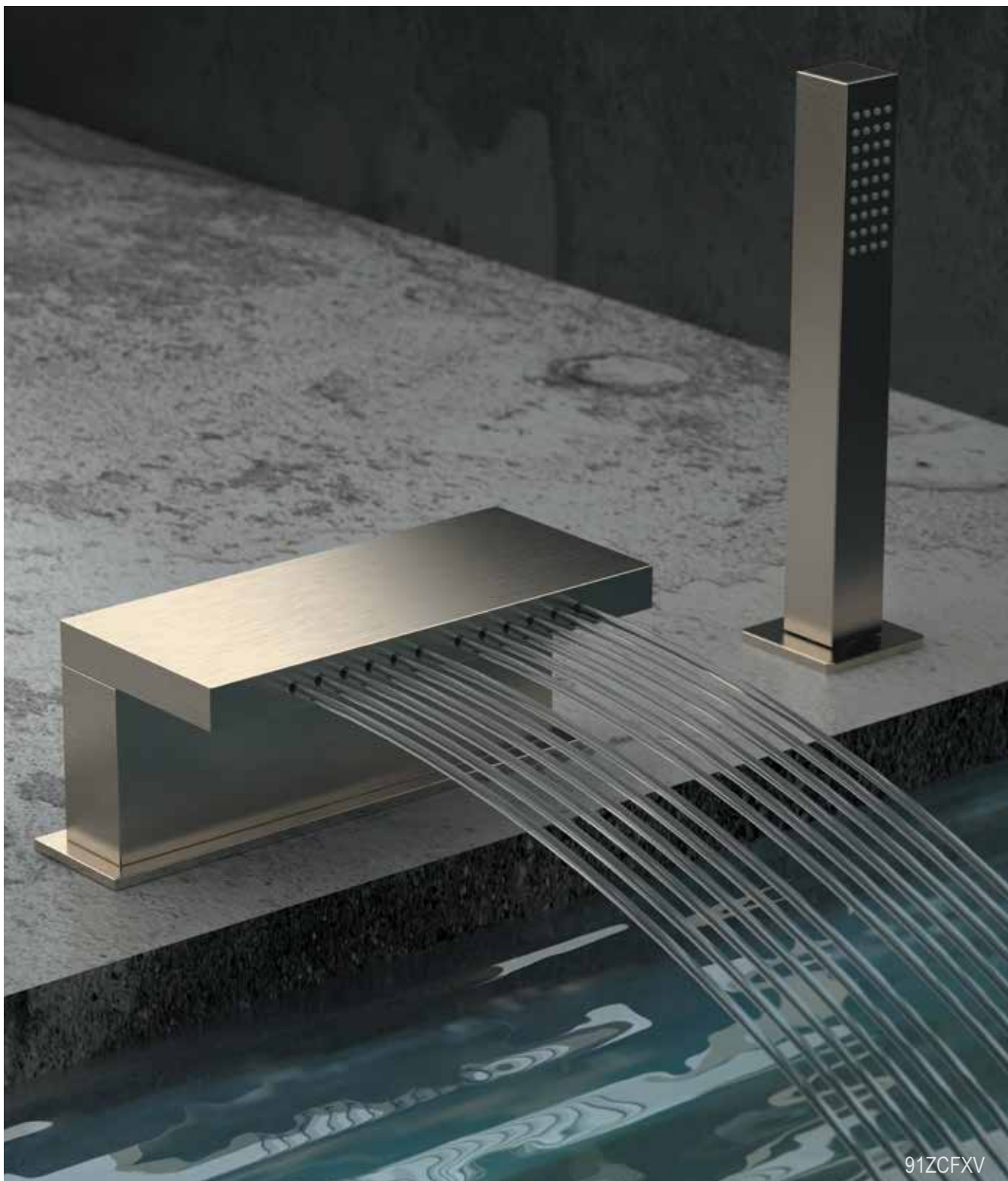

91ZCFXV

//////////////////// OPZIONI DI FINITURA - FINISHING OPTIONS //////////////////////

CR		FIN 1		FIN 2	
	cromo chrome		nero opaco matt black		oro spazzolato brushed gold
	CR		bianco opaco matt white		oro lucido shiny gold
			visual inox visual steel		
			NO		BG
			BO		DO
			XV		

MISCELATORI LAVABO - WASHBASIN MIXERS



QD10
 Miscelatore monocomando lavabo, con scarico quadrato.
Single-lever basin mixer, with squared pop-up waste.

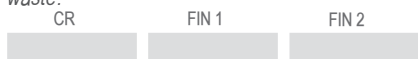

QD11
 Miscelatore monocomando lavabo, senza scarico.
Single-lever basin mixer, without waste.



QD12
 Miscelatore monocomando lavabo, senza scarico e senza foro sul corpo.
Single-lever basin mixer, without waste and without body hole.

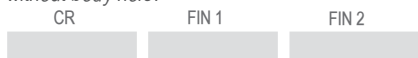

QD10A
 Miscelatore monocomando lavabo medio, con scarico quadrato.
Medium single-lever basin mixer, with squared pop-up waste.

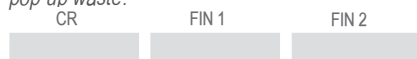

QD11A
 Miscelatore monocomando lavabo medio, senza scarico.
Medium single-lever basin mixer, without waste.

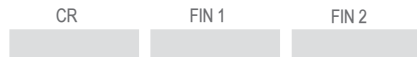

QD12A
 Miscelatore monocomando lavabo medio, senza scarico e senza foro sul corpo.
Medium single-lever basin mixer, without waste and without body hole.



QD10L
 Miscelatore monocomando lavabo alto L, con scarico quadrato click-clack con troppo-pieno.
L high single-lever basin mixer, with squared click-clack waste and overflow.

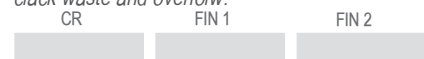

QD11L
 Miscelatore monocomando lavabo alto L, senza scarico.
L high single-lever basin mixer, without waste.

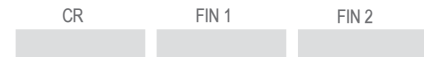

QD10LXL
 Miscelatore monocomando lavabo alto LXL, con scarico quadrato click-clack con troppo-pieno.
Single-lever LXL high washbasin mixer, with squared click-clack waste and overflow.



QD11LXL
 Miscelatore monocomando lavabo alto LXL, senza scarico.
Single-lever LXL high washbasin mixer, without waste.



QD10LXXL
 Miscelatore monocomando lavabo alto LXXL con scarico quadrato click-clack con troppo-pieno.
Single-lever LXXL high washbasin mixer with squared click-clack waste with overflow.



QD42U
 Miscelatore monocomando per lavello, con bocca alta a "U" girevole.
Single-lever one-hole sink mixer, with high "U" swivel spout.

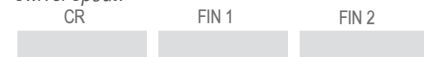

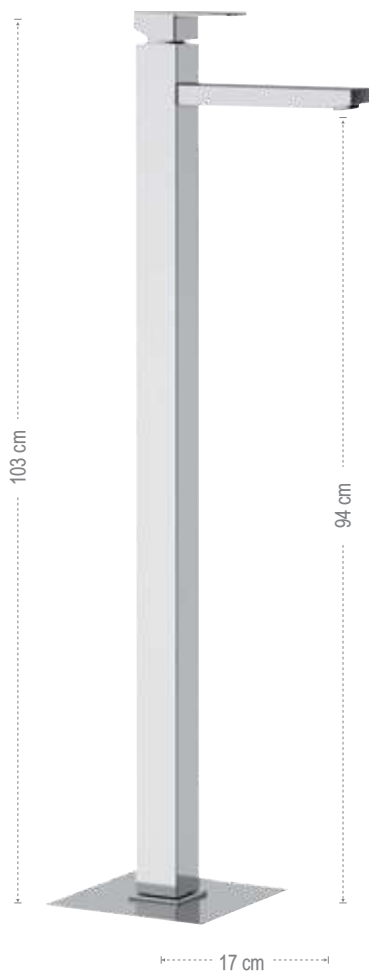

QD18

Miscelatore monocomando lavabo da pavimento con scarico quadrato click-clack con troppo-pieno, prodotto completo.

Single-lever mixer floor mounting with squared click-clack waste with overflow, complete product.



Q08FIS2

Solo parte interna.
Built-in components only.



QD18E

Solo parti esterne.
Exposed components only.

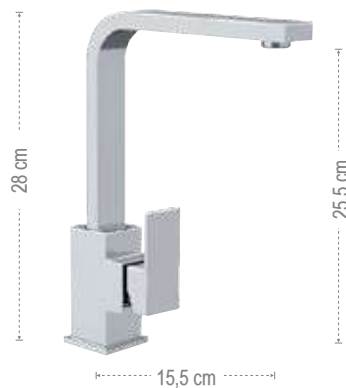

QD10G

Miscelatore monocomando per lavabo con canna a "U" girevole e scarico click-clack quadrato con troppo-pieno.

Single-lever one-hole sink mixer with "U" swivel spout and click-clack waste.

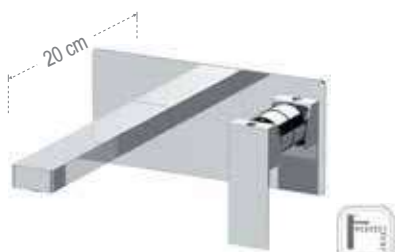

QD15

Miscelatore monocomando a incasso per lavabo, con piastra rettangolare.

Single-lever built-in basin mixer, with rectangular wall plate.



QD15P

Miscelatore monocomando a incasso per lavabo, su due piastre quadrate separate. Lunghezza bocca 20 cm.

Built-in single-lever basin mixer with two separate square plates. Spout length 20 cm.

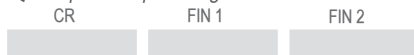

INSTALLAZIONE LIBERA
FREE INSTALLATION

QD15C

Miscelatore lavabo da incasso.
Single-lever built-in basin mixer, in chrome plated brass.

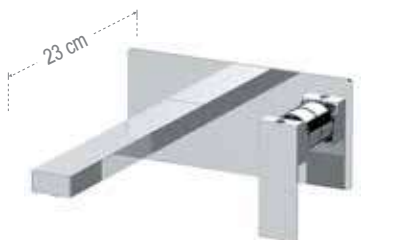

QD15L

Miscelatore monocomando a incasso per lavabo, con piastra rettangolare. Lunghezza bocca 23 cm.

Single-lever built-in basin mixer, with rectangular wall plate. Spout length 23 cm.



QD15PL

Miscelatore monocomando a incasso per lavabo, su due piastre quadrate separate. Lunghezza bocca 23 cm.

Built-in single-lever basin mixer with two separate square plates. Spout length 23 cm.



LAVABO A MURO CON BOX INCASSO - WALL WASHBASIN MIXER WITH BUILT-IN BOX

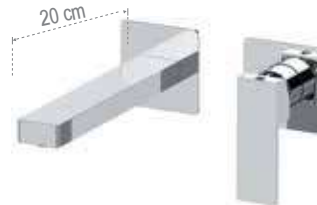
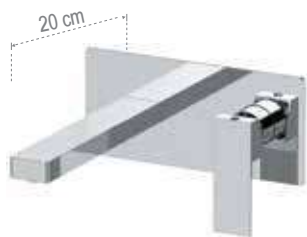

SOLO PARTE ESTERNA - EXPOSED COMPONENTS ONLY:

QD15WB

Parti esterne per miscelatore monocomando a incasso per lavabo da abbinare al box incasso (non incluso). Piastra ultra-piatta. Lunghezza bocca 20 cm.
Exposed components for single-lever built-in basin mixer, with ultra-flat wall plate. To match with the built-in box (not included). Spout length 20 cm.



QD15LWB

Idem sopra, con lunghezza bocca 23 cm.
Same as above, with spout length 23 cm.



SOLO PARTE ESTERNA - EXPOSED COMPONENTS ONLY:

QD15PWB

Parti esterne per miscelatore monocomando a incasso per lavabo da abbinare al box incasso (non incluso). Su due piastre quadrate separate. Lunghezza bocca 20 cm.
Exposed components for single-lever built-in basin mixer, with two separate square plates. To match with the built-in box (not included). Spout length 20 cm.



QD15PLWB

Idem sopra, con lunghezza bocca 23 cm.
Same as above, with spout length 23 cm.



SOLO PARTE INTERNA - BUILT-IN COMPONENTS ONLY:

WBOX15

SOLO PARTE INTERNA - BUILT-IN COMPONENTS ONLY:

WBOX15

BOCCHIE - SPOUTS

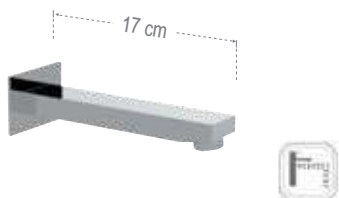

91Q

Bocca incasso per miscelatore vasca/doccia. Lunghezza bocca 17cm.
Built-in spout for bath/shower mixer. Spout length 17cm.

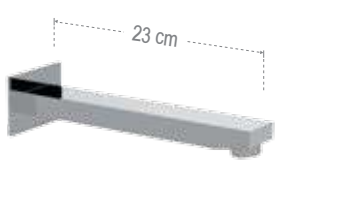

91QL

Bocca incasso per miscelatore vasca/doccia. Lunghezza bocca 23cm.
Built-in spout for bath/shower mixer. Spout length 23cm.

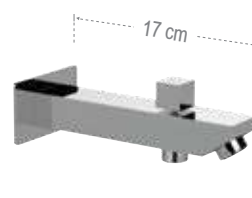

91QD

Bocca incasso con deviatore integrato.
Built-in spout with diverter.



91ZCA

Bocca bordo vasca.
Spout for deck bath/shower.



91ZCF

Bocca bordo vasca.
Spout for deck bath/shower.



91ZC

Bocca incasso con getto a cascata.
Built-in spout with waterfall jet.



MISCELATORI BIDET - BIDET MIXERS

ATELIER



QD20

Miscelatore monocomando bidet, con scarico quadrato.
Single-lever bidet mixer with, with squared pop-up waste.

CR FIN 1 FIN 2



QD21

Miscelatore monocomando bidet, senza scarico.
Single-lever bidet mixer, without waste.

CR FIN 1 FIN 2



QD22

Miscelatore monocomando bidet senza scarico e senza foro sul corpo.
Single-lever bidet mixer without waste and without body hole.

CR FIN 1 FIN 2

CHRONO



QD20

CELEBRITY

ELEMENT

Q DESIGN

X-STYLE

MISCELATORI ESTERNI PER VASCA E DOCCIA - EXPOSED MIXERS FOR BATH AND SHOWER

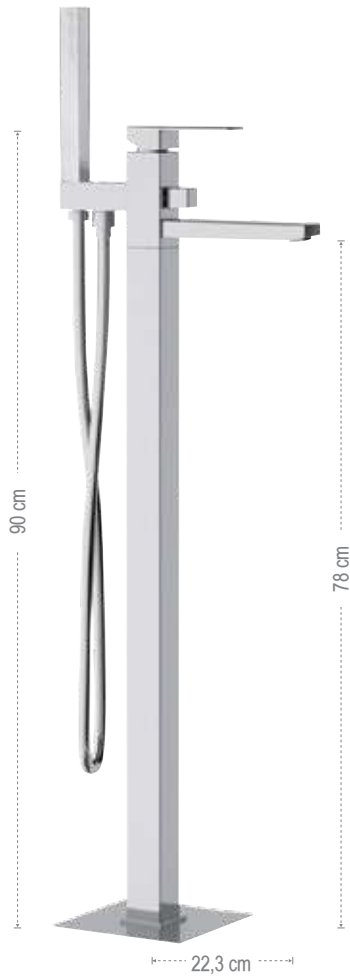

QD08

Miscelatore vasca da pavimento con deviatore, doccia ad 1 funzione in ottone e flessibile 150 cm. Prodotto completo.

Free standing bath mixer floor mounting with diverter, 1 function handshower and flexible hose 150 cm. Complete product.



CR FIN 1 FIN 2

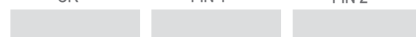

Q08FIS2

Solo parte interna.
Built-in components only.



CR

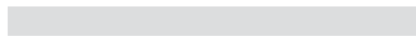

QD08E

Solo parti esterne.
Exposed components only.

CR FIN 1 FIN 2

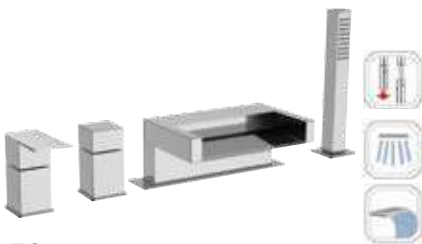

ZC06

Miscelatore monocomando bordo vasca con deviatore, doccia estraibile in ottone e bocca a cascata.

Single-lever deck bath/shower mixer with diverter, pull-out brass handshower and waterfall spout.

CR FIN 1 FIN 2

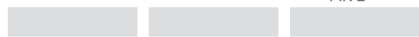

QD02

Miscelatore vasca esterno con kit doccia, flessibile 150 cm e doccia ad una funzione in ottone.

Exposed bath mixer with shower kit, flexible 150 cm and one function brass minimal handshower.

CR FIN 1 FIN 2

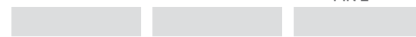

QD05

Miscelatore vasca esterno con kit doccia, senza kit doccia.

Exposed bath mixer with shower kit, without shower kit.

CR FIN 1 FIN 2

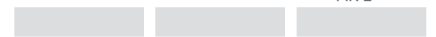

MISCELATORI A INCASSO PER VASCA - BUILT-IN MIXERS FOR BATH



SOLO PARTE ESTERNA - EXPOSED COMPONENTS ONLY:

QD53D2WB

Set a incasso a 2 vie per vasca su piastra unica rettangolare.
2-way built-in set for bathtub on a single rectangular plate.

CR FIN 1 FIN 2



SOLO PARTE ESTERNA - EXPOSED COMPONENTS ONLY:

QD53D2PWB

Set a incasso a 2 vie per vasca su piastre quadrate separate.
2-way built-in set for bathtub on separate square plates.

CR FIN 1 FIN 2

SOLO PARTE INTERNA - BUILT-IN COMPONENTS ONLY:

WBOX97D2

pag 304

SOLO PARTE INTERNA - BUILT-IN COMPONENTS ONLY:

WBOX97D2

pag 304



SOLO PARTE ESTERNA - EXPOSED COMPONENTS ONLY:

QD54D2PWB

Set miscelatore a incasso a 2 vie per vasca/doccia su 3 piastre quadrate. Da completare con la seconda uscita acqua.
2-way built-in mixer set for bathtub / shower on 3 square plates. To be completed with the second water outlet.

CR FIN 1 FIN 2



SOLO PARTE ESTERNA - EXPOSED COMPONENTS ONLY:

QD54D2WB

Set miscelatore a incasso a 2 vie per vasca/doccia su piastra unica rettangolare. Da completare con la seconda uscita.
2-way built-in mixer set for bathtub / shower on single rectangular plate. To be completed with the second water outlet.

CR FIN 1 FIN 2

SOLO PARTE INTERNA - BUILT-IN COMPONENTS ONLY:

WBOX97D2

pag 304

SOLO PARTE INTERNA - BUILT-IN COMPONENTS ONLY:

WBOX97D2

pag 304



SOLO PARTE ESTERNA - EXPOSED COMPONENTS ONLY:

QD54D3PWB

Set miscelatore a incasso a 3 vie per vasca/doccia su 3 piastre quadrate. Da completare con la seconda e la terza uscita acqua.
3-way built-in mixer set for bathtub / shower on 3 separate square plates. To be completed with the second and the third water outlet.

CR FIN 1 FIN 2



SOLO PARTE ESTERNA - EXPOSED COMPONENTS ONLY:

QD54D3WB

Set miscelatore a incasso a 3 vie per vasca/doccia su piastra unica rettangolare. Da completare con la seconda e la terza uscita acqua.
3-way built-in mixer set for bathtub / shower on single rectangular plate. To be completed with the second and the third water outlet.

CR FIN 1 FIN 2

SOLO PARTE INTERNA - BUILT-IN COMPONENTS ONLY:

WBOX97D3

pag 308

SOLO PARTE INTERNA - BUILT-IN COMPONENTS ONLY:

WBOX97D3

pag 308

Set doccia acquistabile separatamente a pagina 427 - Shower set can be purchased separately on page 427

MISCELATORI A INCASSO PER DOCCIA - BUILT-IN MIXERS FOR SHOWER



QD30

Miscelatore monocomando a incasso per doccia completo.
Complete single lever built-in shower mixer.

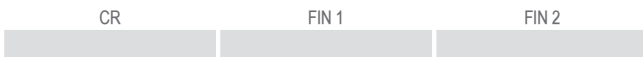

QD09

Miscelatore monocomando a incasso con deviatore per vasca/doccia completo.
Complete single lever built-in bath/shower mixer with diverter.



N09B

Solo parte interna.
Built-in components only.



QD09E

Solo parte esterna.
Exposed components only.



QD09H

Miscelatore a incasso per vasca/doccia con deviatore a 2 vie a vitone ceramico. Per selezionare l'uscita desiderata, la manopola del deviatore deve essere ruotata da una posizione all'altra.
Built-in bath/shower mixer with 2-way diverter with ceramic head valve. To select the desired output, the diverter knob must be turned from one position to the other.

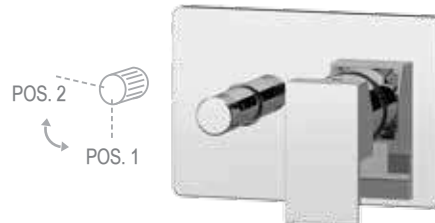

QD09HRG

Miscelatore a incasso per vasca/doccia con deviatore a 2 vie con vitone ceramico, su piastra rettangolare, montaggio orizzontale. Per selezionare l'uscita desiderata, la manopola del deviatore deve essere ruotata da una posizione all'altra.
Built-in bath/shower mixer with 2-way diverter with ceramic head valve, on rectangular plate, horizontal mounting. To select the desired output, the diverter knob must be turned from one position to the other.



N09HB

Solo parte interna.
Built-in components only.



QD09E

Solo parte esterna.
Exposed components only.



N09HRB

Solo parte interna.
Built-in components only.



QD09GE

Solo parte esterna.
Exposed components only.





SOLO PARTE ESTERNA - EXPOSED COMPONENTS ONLY:

QD97D2WB

Set miscelatore a incasso a 2 vie per vasca/doccia su piastra rettangolare. Da completare con la seconda uscita.
2-way built-in shower mixer set on rectangular plate. To be completed with the second water outlet.

CR FIN 1 FIN 2



SOLO PARTE ESTERNA - EXPOSED COMPONENTS ONLY:

QD97D2PWB

Set miscelatore a incasso a 2 vie per vasca/doccia su 3 piastre quadrate. Da completare con la seconda uscita.
2-way built-in shower mixer set on 3 square plates. To be completed with the second water outlet.

CR FIN 1 FIN 2



SOLO PARTE INTERNA - BUILT-IN COMPONENTS ONLY:

WBOX97D2

pag 304

SOLO PARTE INTERNA - BUILT-IN COMPONENTS ONLY:

WBOX97D2

pag 304

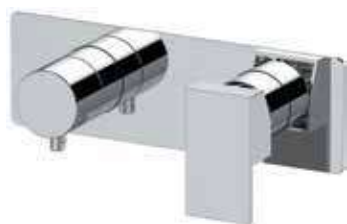

SOLO PARTE ESTERNA - EXPOSED COMPONENTS ONLY:

QD92ZWB

Miscelatore a incasso per vasca/doccia con deviatore a 2 vie di tipo meccanico, su piastra rettangolare.
Built-in bath/shower mixer with 2-way mechanical diverter, on rectangular plate.

CR FIN 1 FIN 2

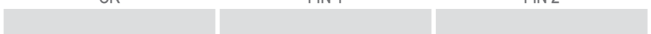

SOLO PARTE INTERNA - BUILT-IN COMPONENTS ONLY:

WBOX92Z

pag 300

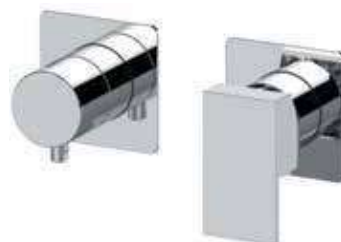

SOLO PARTE ESTERNA - EXPOSED COMPONENTS ONLY:

QD92ZPWB

Miscelatore a incasso per vasca/doccia con deviatore a 2 vie di tipo meccanico, su due piastre quadrate.
Built-in bath/shower mixer with 2-way mechanical diverter, on two square plates.

CR FIN 1 FIN 2



SOLO PARTE INTERNA - BUILT-IN COMPONENTS ONLY:

WBOX92Z

pag 300



Z92

Miscelatore monocomando a incasso per doccia, con deviatore a due posizioni (due uscite ed una entrata) su piastra unica.
Single-lever built-in shower mixer with 2 positions diverter (2 outlets and 1 inlet) on single plate.

CR FIN 1 FIN 2

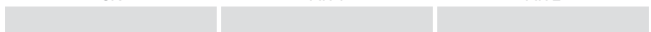



3 VIE
WAYS



SOLO PARTE ESTERNA - EXPOSED COMPONENTS ONLY:

QD97D3WB

Set miscelatore a incasso a 3 vie per vasca/doccia su piastra rettangolare. Da completare con la seconda e la terza uscita acqua.
3-way built-in shower mixer set on rectangular plate. To be completed with the second and the third water outlet.

CR FIN 1 FIN 2

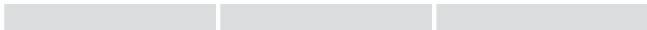

SOLO PARTE INTERNA - BUILT-IN COMPONENTS ONLY:

WBOX97D3

> pag 308



SOLO PARTE ESTERNA - EXPOSED COMPONENTS ONLY:

QD97D3PWB

Set miscelatore a incasso a 3 vie per vasca/doccia su 3 piastre quadrate. Da completare con la seconda e la terza uscita acqua.
3-way built-in bath/shower mixer set on 3 square plates. To be completed with the second and the third water outlet.

CR FIN 1 FIN 2

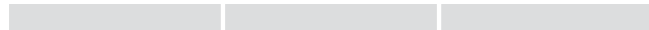

SOLO PARTE INTERNA - BUILT-IN COMPONENTS ONLY:

WBOX97D3

> pag 308

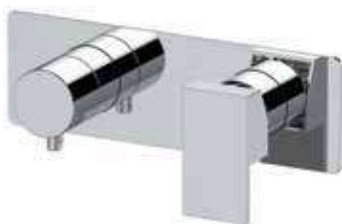

SOLO PARTE ESTERNA - EXPOSED COMPONENTS ONLY:

QD93ZWB

Miscelatore a incasso per vasca/doccia con deviatore a 3 vie di tipo meccanico, su piastra rettangolare.
Built-in bath/shower mixer with 3-way mechanical diverter, on rectangular plate.

CR FIN 1 FIN 2

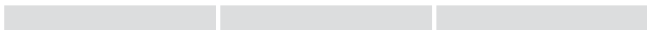

SOLO PARTE INTERNA - BUILT-IN COMPONENTS ONLY:

WBOX93Z

> pag 302

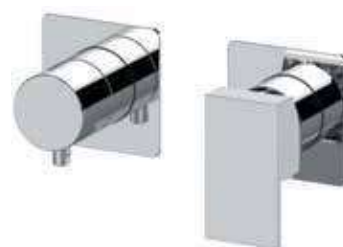

SOLO PARTE ESTERNA - EXPOSED COMPONENTS ONLY:

QD93ZPWB

Miscelatore a incasso per vasca/doccia con deviatore a 3 vie di tipo meccanico, su due piastre quadrate.
Built-in bath/shower mixer with 3-way mechanical diverter, on two square plates.

CR FIN 1 FIN 2

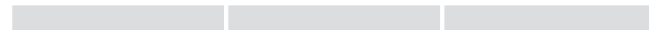

SOLO PARTE INTERNA - BUILT-IN COMPONENTS ONLY:

WBOX93Z

> pag 302



Z93

Miscelatore monocomando per doccia con deviatore a 3 vie e 3 posizioni (una entrata e tre uscite) su unica piastra.
Single lever built-in shower mixer with 3 ways diverter and 3 positions (1 inlet and 3 outlets) on single plate.

CR FIN 1 FIN 2



4/5 VIE WAYS



Z94

Miscelatore monocomando per doccia, con deviatore a 4 posizioni (4 uscite ed 1 entrata) su piastra unica.

Single-lever shower mixer with 4 positions diverter (4 outlets and 1 inlet,) on single plate.

CR FIN 1 FIN 2



Z95

Miscelatore monocomando per doccia, con deviatore a 5 posizioni (5 uscite ed una entrata) su piastra unica.

Single-lever shower mixer with 5 positions diverter (5 outlets and 1 inlet) on single plate.

CR FIN 1 FIN 2

SALISCENDI E COLONNE DOCCIA - SLIDING RAILS AND SHOWER COLUMNS



QD37

Set doccia composto da: miscelatore esterno doccia, colonna doccia quadra con saliscendi e deviatore, doccia 1 funzione in ottone cromato 317SS; soffione 20x20 cm in ottone 359SSX; flessibile 150 cm.

Shower set including: exposed shower mixer, square shower column with sliding rail and diverter, 1-function hand shower in chromed brass 317SS; 20x20 cm brass shower head 359SSX; flexible hose 150 cm.

CR FIN 1 FIN 2



317R317RR

Saliscendi e doccia tutto in ottone serie ultrapiatta rettangolare minimale lusso, flessibile 150 cm.

Deluxe sliding rail and handshower ultraflat serie, rectangular minimal, all in brass, flexible hose 150 cm.

CR



X-STYLE

L'ESSENZA DEL MINIMALISMO
THE ESSENCE OF MINIMALISM



L'utilizzo di una cartuccia dal diametro di 25 mm rende il corpo del miscelatore particolarmente slanciato, mentre la bocca di erogazione accompagna dolcemente il fluire dell'acqua con una morbida curvatura. Una collezione di rubinetteria monocomando dall'eleganza intramontabile, disponibile in un'ampia gamma di finiture. La serie è dotata di cartuccia a dischi ceramici Ø 25 mm.

The use of a 25 mm diameter cartridge makes the mixer body particularly slender, while the spout gently accompanies the flow of water with a soft curvature. A collection of single-lever mixers with timeless elegance, available in a wide range of finishes. The series is equipped with a Ø 25 mm ceramic disc cartridge.





X-STYLE

X53D2PWB



X15PL



X08DO



X10LXLBR

//////////////////// OPZIONI DI FINITURA - FINISHING OPTIONS //////////////////////

CR		FIN 1		FIN 2	
	cromo chrome		nero opaco matt black		cromo nero spazzolato brushed black chrome
	CR		bianco opaco matt white		oro spazzolato brushed gold
			visual inox visual steel		oro lucido shiny gold
			oil bronze oil bronze		rame spazzolato brushed copper
			NO		CFP
			BO		BG
			XV		DO
			BR		RP

MISCELATORI LAVABO - WASHBASIN MIXERS



X10
Miscelatore monocomando lavabo, con scarico.
Single-lever basin mixer, with pop-up waste.

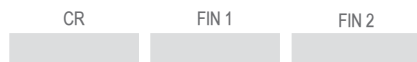

X10A
Monocomando lavabo con bocca lunga, con scarico.
Single-lever basin mixer with long spout and pop-up waste



X10LXL
Miscelatore monocomando lavabo alto XL, con scarico click-clack con troppo-pieno.
XL high single-lever basin mixer, with click-clack waste and overflow.

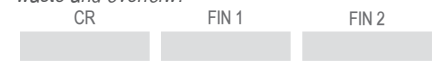

X12
Miscelatore monocomando lavabo, senza scarico e senza foro sul corpo.
Single-lever basin mixer, without waste and without body hole.

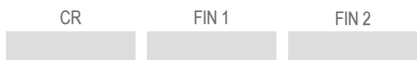

X12A
Monocomando lavabo con bocca lunga, senza scarico e senza foro sul corpo.
Single-lever basin mixer with long spout, without waste and without body hole.



X11LXL
Miscelatore monocomando lavabo alto XL, senza scarico.
XL high single-lever basin mixer, without waste.

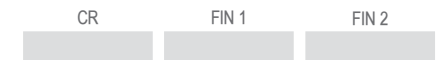

X72
Miscelatore monocomando monoforo con canna alta a "U" girevole.
Single-lever sink mixer high movable "U" spout.



X72C
miscelatore monocomando per lavello con canna corta a "u", tipo lusso.
Single-lever one-hole sink mixer with short "u" spout, luxury type.



X15
Miscelatore monocomando a incasso per lavabo, con piastra orizzontale in ottone.
Single-lever built-in basin mixer, with horizontal wall plate in brass.



X15L
Miscelatore monocomando a incasso per lavabo, con piastra orizzontale in ottone, lunghezza bocca 19 cm.
Single-lever built-in basin mixer, with horizontal wall plate in brass, spout length 19 cm.



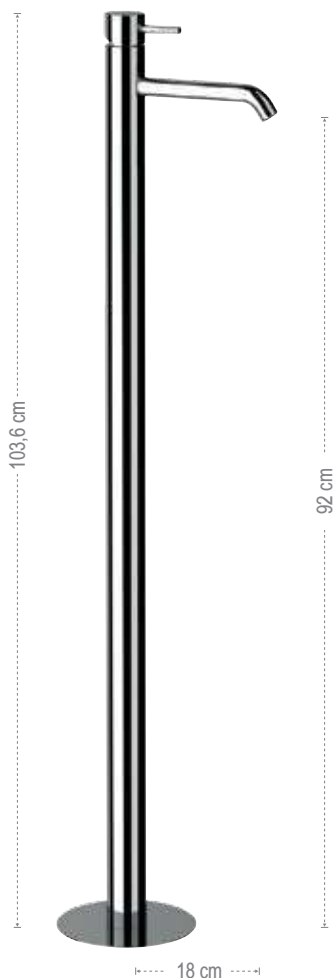

X18

Miscelatore monocomando lavabo da pavimento con scarico click-clack con troppo-pieno. Prodotto completo.
Single-lever mixer floor mounting with click-clack waste with overflow. Complete product.

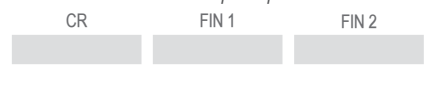

Q08FIS2

Solo parte interna.
Built-in components only.



X18E

Solo parti esterne.
Exposed components only.



X57

Miscelatore monocomando lavabo due fori senza scarico.
Two holes single-lever washbasin mixer without waste.



X57L

Miscelatore monocomando per lavabo a due fori, con bocca L, altezza 33,2cm. Scarico non incluso.
2-holes single-lever basin mixer, with L spout, height 33.2 cm. Waste not included.

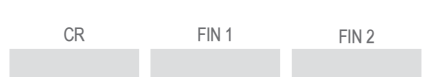

X15P

Miscelatore monocomando a incasso per lavabo, su due piastre tonde separate. Lunghezza bocca 17 cm.
Built-in single-lever basin mixer with two separate round plates. Spout length 17 cm.



X15Q

Miscelatore monocomando a incasso per lavabo, con piastra rettangolare in ottone.
Single-lever built-in basin mixer, with rectangular wall plate in brass.



X15C

Miscelatore monocomando lavabo da incasso con piastre separate Ø90 in libera installazione.
Built-in basin single-lever mixer with separated plates Ø90, free installation



X15PL

Miscelatore monocomando a incasso per lavabo, su due piastre tonde separate. Lunghezza bocca 19 cm.
Built-in single-lever basin mixer with two separate round plates. Spout length 19 cm.



X15QL

Miscelatore monocomando a incasso per lavabo, con piastra rettangolare in ottone, lunghezza bocca 19 cm.
Single-lever built-in basin mixer, with rectangular wall plate in brass, spout length 19 cm.



X15LC

Miscelatore monocomando lavabo da incasso con bocca 19cm, piastre separate Ø90 in libera installazione.
Built-in basin single-lever mixer with spout 19cm, separated plates Ø90, free installation.





Miscelatore da soffitto in ottone, con miscelazione e controllo flusso integrati nella bocca di erogazione.
Ceiling mixer in brass, with mixing and flow control integrated in the outlet spout.

N17

Lunghezza - Length 166 cm.
 CR

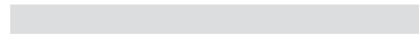

N17L

Lunghezza - Length 181 cm.
 CR

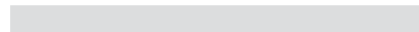

N17LXL

Lunghezza - Length 231 cm.
 CR

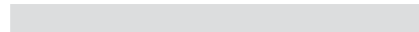

Miscelatore da soffitto in ottone, con miscelazione e controllo flusso integrati nella bocca di erogazione, dispositivo COLOR LED LIGHT.
Ceiling mixer in brass, with mixing and flow control integrated in the outlet spout, including COLOR LED LIGHT device.

NR17

Lunghezza - Length 166 cm.
 CR

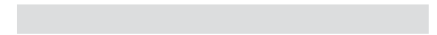

NR17L

Lunghezza - Length 181 cm.
 CR



NR17LXL

Lunghezza - Length 231 cm.
 CR

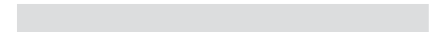

LAVABO A MURO CON BOX INCASSO - WALL WASHBASIN MIXER WITH BUILT-IN BOX

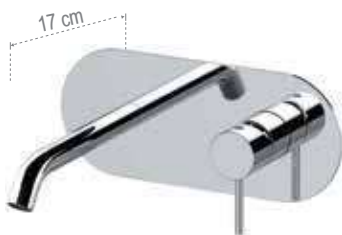

SOLO PARTE ESTERNA - EXPOSED COMPONENTS ONLY:

X15WB

Parti esterne per miscelatore monocomando a incasso per lavabo da abbinare al box incasso (non incluso). Piastra ultra-piatta. Lunghezza bocca 17 cm.
Exposed components for single-lever built-in basin mixer, with ultra-flat wall plate. To match with the built-in box (not included). Spout length 17 cm.

CR

FIN 1

FIN 2

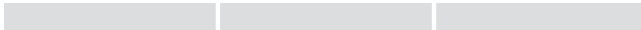

X15LWB

Idem sopra, con lunghezza bocca 19 cm.
Same as above, with spout length 19 cm.

CR

FIN 1

FIN 2

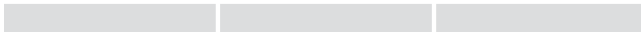

SOLO PARTE INTERNA - BUILT-IN COMPONENTS ONLY:

WBOX15



SOLO PARTE ESTERNA - EXPOSED COMPONENTS ONLY:

X15PWB

Parti esterne per miscelatore monocomando a incasso per lavabo da abbinare al box incasso (non incluso). Su due piastre tonde separate. Lunghezza bocca 17 cm.

Exposed components for single-lever built-in basin mixer, with two separate round plates. To match with the built-in box (not included). Spout length 17 cm.

CR

FIN 1

FIN 2

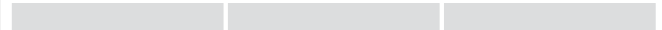

X15PLWB

Idem sopra, con lunghezza bocca 19 cm.
Same as above, with spout length 19 cm.

CR

FIN 1

FIN 2

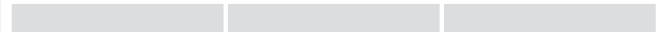

SOLO PARTE INTERNA - BUILT-IN COMPONENTS ONLY:

WBOX15

BOCCHIE - SPOUTS



Bocca da soffitto in ottone.
Ceiling spout in brass.

91VN2

Lunghezza - Length 166 cm.

CR

91VLN2

Lunghezza - Length 181 cm.

CR

Bocca da soffitto in ottone, dispositivo COLOR LED LIGHT.
Ceiling spout in brass, including COLOR LED LIGHT device.

91VNR

Lunghezza - Length 166 cm.

CR



91VLNR

Lunghezza - Length 181 cm.

CR

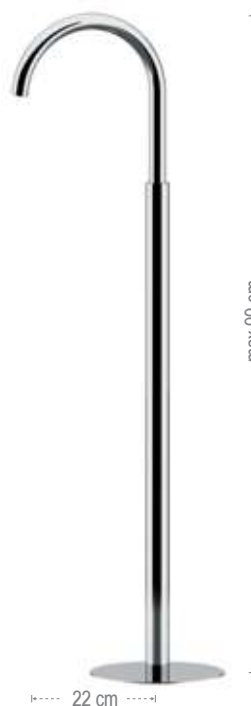

91PN2

Bocca free-standing con installazione a pavimento per vasca.
Free-standing floor mounted spout for bathtub.

CR

FIN 1

FIN 2

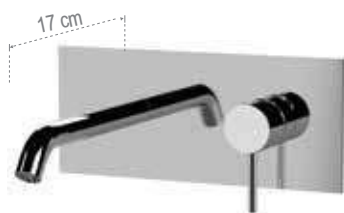

SOLO PARTE ESTERNA - EXPOSED COMPONENTS ONLY:

X15QWB

Parti esterne per miscelatore monocomando a incasso per lavabo da abbinare al box incasso (non incluso). Con piastra rettangolare in ottone. Lunghezza bocca 17 cm.

Exposed components for single-lever built-in basin mixer, with rectangular wall plate in brass. To match with the built-in box (not included). Spout length 17 cm.

CR

FIN 1

FIN 2

X15QLWB

Idem sopra, con lunghezza bocca 19 cm.
Same as above, with spout length 19 cm.

CR

FIN 1

FIN 2

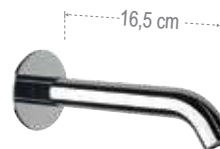

91X

Bocca incasso per miscelatore vasca/doccia, lunghezza 16,5 cm.
Built-in spout for bath/shower mixer, length 16,5 cm

CR

FIN 1

FIN 2

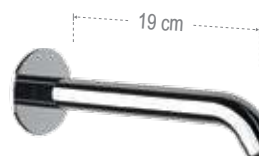

91XL

Bocca incasso per miscelatore vasca/doccia, lunghezza 19 cm.
Built-in spout for bath/shower mixer, length 19 cm.

CR

FIN 1

FIN 2

SOLO PARTE INTERNA - BUILT-IN COMPONENTS ONLY:

WBOX15

ATELIER

CHRONO

CELEBRITY

ELEMENT

Q DESIGN

X-STYLE

MISCELATORI BIDET - BIDET MIXERS



X20
Miscelatore monocomando bidet, con scarico.
Single-lever bidet mixer, with pop-up waste.

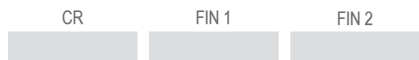

X20L
Miscelatore monocomando bidet con scarico, modello L.
Single-lever bidet mixer, L model, with pop-up waste.



X65W
Miscelatore incasso per shut-off con supporto doccia/presa acqua integrato, attacco conico da 1/2", tutto in ottone, con doccetta shut-off e flessibile cm 120.
Built-in shower mixer with integrated shower holder/water punch on flange all in brass, with 1/2 connection, with shut-off and flexible hose cm 120.



X22
Miscelatore monocomando bidet, senza scarico e senza foro sul corpo.
Single-lever bidet mixer, without waste and without body hole.



X22L
Miscelatore monocomando bidet modello L, senza scarico e senza foro sul corpo.
Single-lever bidet mixer L-model, without pop-waste and without body hole.



N64W
Miscelatore shut-off con cartuccia progressiva, apertura su acqua fredda e passaggio ad acqua calda tramite rotazione di maniglia unica, comprensivo di doccetta shut-off e flessibile doccia cm 120.
Shut-off mixer with progressive cartridge, opening with cold water, switching on hot water by rotating one single handle including shut-off and shower flexible 120 cm.



MISCELATORI ESTERNI PER VASCA E DOCCIA - EXPOSED MIXERS FOR BATH AND SHOWER

ATELIER

CHRONO

CELEBRITY

ELEMENT

Q DESIGN

X-STYLE

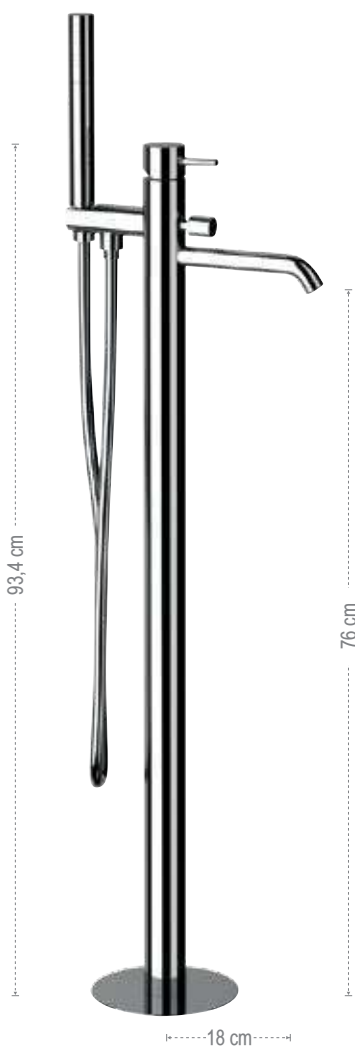

X08

Miscelatore vasca da pavimento, con deviatore, flessibile 150 cm e doccetta ad una funzione in ottone. Prodotto completo.

Freestanding bath mixer, with diverter, flexible 150 cm and one function brass minimal handshower. Complete product.

CR FIN 1 FIN 2

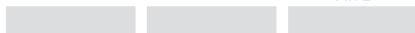

Q08FIS2

Solo parte interna.
Built-in components only.



CR

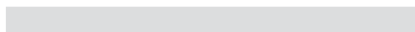

X08E

Solo parti esterne.
Exposed components only.

CR FIN 1 FIN 2

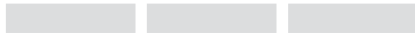

X02

Miscelatore vasca esterno con kit doccia, flessibile 150 cm e doccetta ad una funzione in ottone.

Exposed bath mixer with shower kit, flexible 150 cm and one function brass minimal handshower.

CR FIN 1 FIN 2

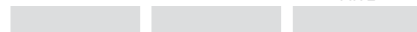

X05

Miscelatore vasca esterno senza kit doccia.
Exposed bath mixer without shower kit.

CR FIN 1 FIN 2

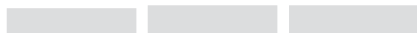

X39

Monocomando doccia esterno, con kit doccia, flessibile 150 cm e doccetta ad una funzione in ottone.

Exposed shower mixer, with shower kit, flexible 150 cm and one function brass minimal handshower.

CR FIN 1 FIN 2

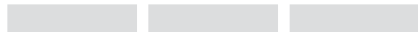

X31

Monocomando doccia esterno, senza kit doccia.
Exposed shower mixer, without shower kit.

CR FIN 1 FIN 2

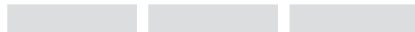

MISCELATORI A INCASSO PER VASCA - BUILT-IN MIXERS FOR BATH



2 VIE
WAYS



SOLO PARTE ESTERNA - EXPOSED COMPONENTS ONLY:

X53D2WB

Set a incasso a 2 vie per vasca su piastra unica rettangolare.
2-way built-in set for bathtub on a single rectangular plate.

CR FIN 1 FIN 2



SOLO PARTE ESTERNA - EXPOSED COMPONENTS ONLY:

X53D2PWB

Set a incasso a 2 vie per vasca su piastre tonde separate.
2-way built-in set for bathtub on separate round plates.

CR FIN 1 FIN 2

SOLO PARTE INTERNA - BUILT-IN COMPONENTS ONLY:

WBOX97D2

pag 304

SOLO PARTE INTERNA - BUILT-IN COMPONENTS ONLY:

WBOX97D2

pag 304



2 VIE
WAYS



SOLO PARTE ESTERNA - EXPOSED COMPONENTS ONLY:

X54D2WB

Set miscelatore a incasso a 2 vie per vasca/doccia su piastra unica rettangolare. Da completare con la seconda uscita.
2-way built-in mixer set for bathtub / shower on single rectangular plate. To be completed with the second water outlet.

CR FIN 1 FIN 2



SOLO PARTE ESTERNA - EXPOSED COMPONENTS ONLY:

X54D2PWB

Set miscelatore a incasso a 2 vie per vasca/doccia su 3 piastre tonde. Da completare con la seconda uscita acqua.
2-way built-in mixer set for bathtub / shower on 3 round plates. To be completed with the second water outlet.

CR FIN 1 FIN 2

SOLO PARTE INTERNA - BUILT-IN COMPONENTS ONLY:

WBOX97D2

pag 304

SOLO PARTE INTERNA - BUILT-IN COMPONENTS ONLY:

WBOX97D2

pag 304



INSTALLAZIONE LIBERA
FREE INSTALLATION

2 VIE
WAYS



X96S0390

Set miscelatore vasca a incasso compost da: Miscelatore a incasso orizzontale con deviatore, bocca ad incasso (91X), presa d'acqua a muro con supporto doccetta, doccetta minimale in ottone 1 funzione (317MM) e flessibile in PVC atossico da 150 cm.

NB: Le parti a incasso sono indipendenti tra loro e permettono di posizionare i singoli elementi liberamente in base alle esigenze del progetto.

Built in bath set including: Horizontal built in mixer with diverter, built in spout (91X), wall water connection with shower older, 1 function brass hand shower 317MM and flexible hose in atoxic PVC 150 cm.

NB: The built-in parts are independent of each other and allow the individual elements to be positioned freely according to each project needs.

CR FIN 1 FIN 2

3 VIE
WAYS3 VIE
WAYS

SOLO PARTE ESTERNA - EXPOSED COMPONENTS ONLY:

X54D3WB

Set miscelatore a incasso a 3 vie per vasca/doccia su piastra unica rettangolare. Da completare con la seconda e la terza uscita acqua.

3-way built-in mixer set for bathtub / shower on single rectangular plate. To be completed with the second and the third water outlet.

CR

FIN 1

FIN 2

3 VIE
WAYS

SOLO PARTE ESTERNA - EXPOSED COMPONENTS ONLY:

X54D3PWB

Set miscelatore a incasso a 3 vie per vasca/doccia su 3 piastre tonde. Da completare con la seconda e la terza uscita acqua.

3-way built-in mixer set for bathtub / shower on 3 separate round plates. To be completed with the second and the third water outlet.

CR

FIN 1

FIN 2

SOLO PARTE INTERNA - BUILT-IN COMPONENTS ONLY:

WBOX97D3

pag 308

SOLO PARTE INTERNA - BUILT-IN COMPONENTS ONLY:

WBOX97D3

pag 308

MISCELATORI A INCASSO PER DOCCIA - BUILT-IN MIXERS FOR SHOWER

1 VIA
WAY**X30L**

Miscelatore a incasso per doccia, su piastra tonda ultra-piatta.
Built-in shower mixer, ultra-flat round wall plate.

CR

FIN 1

FIN 2

**X30Q**

Miscelatore a incasso per doccia, su piastra quadrata ultra-piatta.
Built-in shower mixer, ultra-flat square wall plate.

CR

FIN 1

FIN 2

Set doccia acquistabile separatamente a pagina 427 - Shower set can be purchased separately on page 427



X09L

Miscelatore a incasso per vasca/doccia con deviatore a pressione, su piastra tonda ultra-piatta.
Built-in bath/shower mixer with push button diverter, on ultra-flat round wall plate.



X09Q

Miscelatore a incasso per vasca/doccia con deviatore a pressione, su piastra quadrata ultra-piatta.
Built-in bath/shower mixer with push button diverter, on ultra-flat square wall plate.



N09B

Solo parte interna.
Built-in components only.



X09LE

Solo parte esterna.
Exposed components only.



N09B

Solo parte interna.
Built-in components only.



X09QE

Solo parte esterna.
Exposed components only.

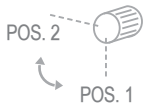

X09HL

Miscelatore a incasso per vasca/doccia con deviatore a 2 vie a vitone ceramico. Per selezionare l'uscita desiderata, la manopola del deviatore deve essere ruotata da una posizione all'altra.
Built-in bath/shower mixer with 2-way diverter with ceramic head valve. To select the desired output, the diverter knob must be turned from one position to the other.

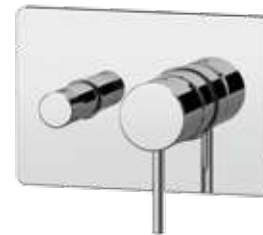

X09HRG

Miscelatore a incasso per vasca/doccia con deviatore a 2 vie con vitone ceramico, su piastra rettangolare, montaggio orizzontale. Per selezionare l'uscita desiderata, la manopola del deviatore deve essere ruotata da una posizione all'altra.
Built-in bath/shower mixer with 2-way diverter with ceramic head valve, on rectangular plate, horizontal mounting. To select the desired output, the diverter knob must be turned from one position to the other.



N09HB

Solo parte interna.
Built-in components only.



X09LE

Solo parte esterna.
Exposed components only.



N09HRB

Solo parte interna.
Built-in components only.



X09GE

Solo parte esterna.
Exposed components only.



INSTALLAZIONE LIBERA
FREE INSTALLATION



X96

Miscelatore e deviatore a 2 vie su piastre separate.
Built-in shower mixer with 2-way diverter on double plate.



INSTALLAZIONE LIBERA
FREE INSTALLATION



XT96

Miscelatore da incasso termostatico con deviatore 2 vie e piastre separate Ø90 con libera installazione.
Thermostatic built-in mixer with 2 way diverter and separated plates Ø90, free installation.



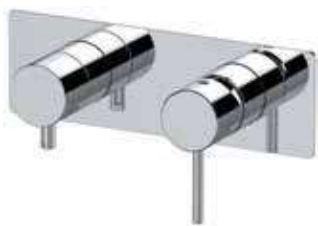

SOLO PARTE ESTERNA - EXPOSED COMPONENTS ONLY:

X92ZWB

Miscelatore a incasso per vasca/doccia con deviatore a 2 vie di tipo meccanico, su piastra rettangolare.
Built-in bath/shower mixer with 2-way mechanical diverter, on rectangular plate.

CR FIN 1 FIN 2

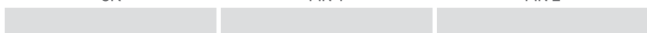

SOLO PARTE INTERNA - BUILT-IN COMPONENTS ONLY:

WBOX92Z

pag 300



SOLO PARTE ESTERNA - EXPOSED COMPONENTS ONLY:

X92ZPWB

Miscelatore a incasso per vasca/doccia con deviatore a 2 vie di tipo meccanico, su due piastre tonde.
Built-in bath/shower mixer with 2-way mechanical diverter, on two round plates.

CR FIN 1 FIN 2

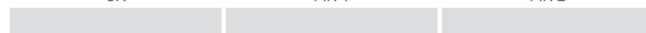

SOLO PARTE INTERNA - BUILT-IN COMPONENTS ONLY:

WBOX92Z

pag 300



X92

Miscelatore monocomando a incasso per doccia, con deviatore a due posizioni (due uscite ed una entrata) su piastra unica.
Single-lever built-in shower mixer with 2 positions diverter (2 outlets and 1 inlet) on single plate.

CR FIN 1 FIN 2

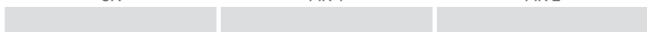

X92Q

Miscelatore monocomando per doccia con deviatore a 2 posizioni su piastra unica squadrata.
Single-lever shower mixer, with 2 positions diverter on single square plate.

CR FIN 1 FIN 2

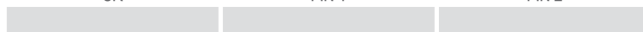

SOLO PARTE ESTERNA - EXPOSED COMPONENTS ONLY:

X97D2PWB

Set miscelatore a incasso a 2 vie per vasca/doccia su 3 piastre tonde. Da completare con la seconda uscita.
2-way built-in shower mixer set on 3 round plates. To be completed with the second water outlet.

CR FIN 1 FIN 2

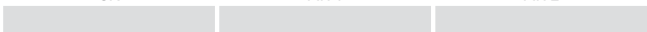

SOLO PARTE INTERNA - BUILT-IN COMPONENTS ONLY:

WBOX97D2

pag 304



SOLO PARTE ESTERNA - EXPOSED COMPONENTS ONLY:

X97D2WB

Set miscelatore a incasso a 2 vie per vasca/doccia su piastra rettangolare. Da completare con la seconda uscita.
2-way built-in shower mixer set on rectangular plate. To be completed with the second water outlet.

CR FIN 1 FIN 2

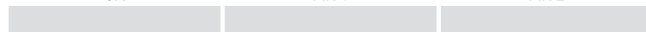

SOLO PARTE INTERNA - BUILT-IN COMPONENTS ONLY:

WBOX97D2

pag 304

3 VIE
WAYS

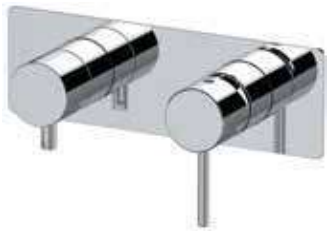

SOLO PARTE ESTERNA - EXPOSED COMPONENTS ONLY:

X93ZWB

Miscelatore a incasso per vasca/doccia con deviatore a 3 vie di tipo meccanico, su piastra rettangolare.

Built-in bath/shower mixer with 3-way mechanical diverter, on rectangular plate.

CR FIN 1 FIN 2

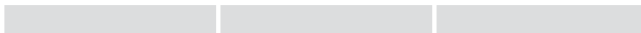

SOLO PARTE ESTERNA - EXPOSED COMPONENTS ONLY:

X93ZPWB

Miscelatore a incasso per vasca/doccia con deviatore a 3 vie di tipo meccanico, su due piastre tonde.

Built-in bath/shower mixer with 3-way mechanical diverter, on two round plates.

CR FIN 1 FIN 2

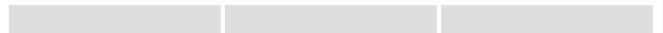

SOLO PARTE INTERNA - BUILT-IN COMPONENTS ONLY:

WBOX93Z

pag 302

SOLO PARTE INTERNA - BUILT-IN COMPONENTS ONLY:

WBOX93Z

pag 302

3 VIE
WAYS



X93

Miscelatore monocomando per doccia con deviatore a tre vie e tre posizioni (una entrata e tre uscite) su unica piastra.

Single lever built-in shower mixer with 3-ways and 3-positions diverter (1 inlet and 3 outlets) on single plate.

CR FIN 1 FIN 2

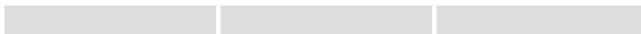

X93Q

Miscelatore monocomando per doccia con deviatore a 3 posizioni (3 uscite ed 1 entrata) su piastra unica quadrata.

Single-lever shower mixer with 3-positions diverter (3 outlets and 1 inlet) on single square plate.

CR FIN 1 FIN 2

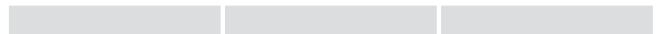

3 VIE
WAYS

INSTALLAZIONE LIBERA
FREE INSTALLATION



X96D3

Miscelatore e deviatore a 3 vie su piastre separate.

Built-in shower mixer with 3-way diverter on double plate.

CR FIN 1 FIN 2

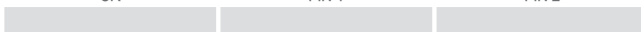

INSTALLAZIONE LIBERA
FREE INSTALLATION



XT96D3

Miscelatore da incasso termostatico con deviatore 3 vie e piastre separate Ø90 con libera installazione.

Thermostatic built-in mixer with 3 way diverter and separated plates Ø90, free installation.

CR FIN 1 FIN 2

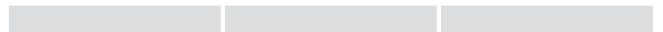



3 VIE WAYS



SOLO PARTE ESTERNA - EXPOSED COMPONENTS ONLY:

X97D3PWB

Set miscelatore a incasso a 3 vie per vasca/doccia su 3 piastre tonde. Da completare con la seconda e la terza uscita acqua.
 3-way built-in bath/shower mixer set on 3 round plates. To be completed with the second and the third water outlet.

CR FIN 1 FIN 2

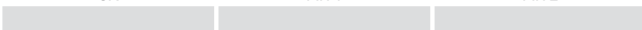

SOLO PARTE INTERNA - BUILT-IN COMPONENTS ONLY:

WBOX97D3

pag 308



SOLO PARTE ESTERNA - EXPOSED COMPONENTS ONLY:

X97D3WB

Set miscelatore a incasso a 3 vie per vasca/doccia su piastra rettangolare. Da completare con la seconda e la terza uscita acqua.
 3-way built-in shower mixer set on rectangular plate. To be completed with the second and the third water outlet.

CR FIN 1 FIN 2

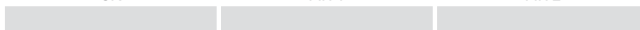

SOLO PARTE INTERNA - BUILT-IN COMPONENTS ONLY:

WBOX97D3

pag 308



4/5 VIE WAYS



X94Q

Miscelatore monocomando per doccia, con deviatore a 4 posizioni (4 uscite ed 1 entrata) su piastra unica squadrata.
 Single-lever shower mixer with 4 positions diverter (4 outlets and 1 inlet,) on single square plate.

CR FIN 1 FIN 2

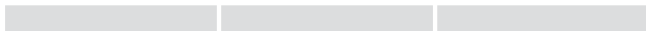

X95Q

Miscelatore monocomando per doccia, con deviatore a 5 posizioni (5 uscite ed una entrata) su piastra unica squadrata.
 Single-lever shower mixer with 5 positions diverter (5 outlets and 1 inlet) on single square plate.

CR FIN 1 FIN 2

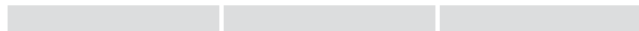

4/5 VIE WAYS



X94

Miscelatore monocomando per doccia, con deviatore a 4 posizioni (4 uscite ed 1 entrata) su piastra unica.
 Single-lever shower mixer with 4 positions diverter (4 outlets and 1 inlet,) on single plate.

CR FIN 1 FIN 2

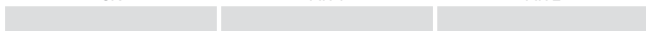

X95

Miscelatore monocomando per doccia, con deviatore a 5 posizioni (5 uscite ed una entrata) su piastra unica.
 Single-lever shower mixer with 5 positions diverter (5 outlets and 1 inlet) on single plate.

CR FIN 1 FIN 2

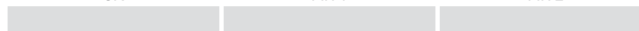

SALISCENDI E COLONNE DOCCIA - SLIDING RAILS AND SHOWER COLUMNS

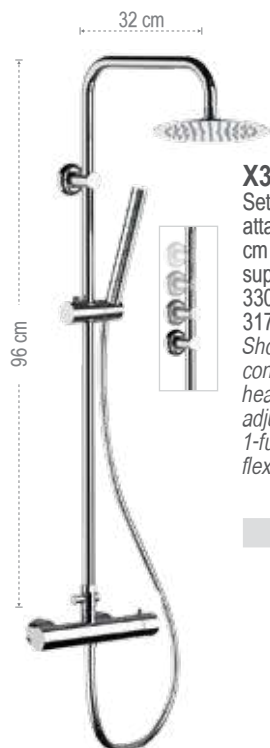

X37X7MCUFM20

Set doccia composto da: miscelatore esterno con attacco superiore, soffione in acciaio inox Ø 20 cm 357UFM20X, colonna doccia con fissaggio superiore regolabile in altezza, con deviatore 330X, doccetta minimale in ottone, 1 funzione 317MM, flessibile 150 cm.

Shower set including: exposed mixer with upper connection, stainless steel Ø 20cm shower head 357UFM20X, shower column with height-adjustable upper fixing and diverter 330X, 1-function brass hand shower 317MM, 150 cm flexible hose.

CR

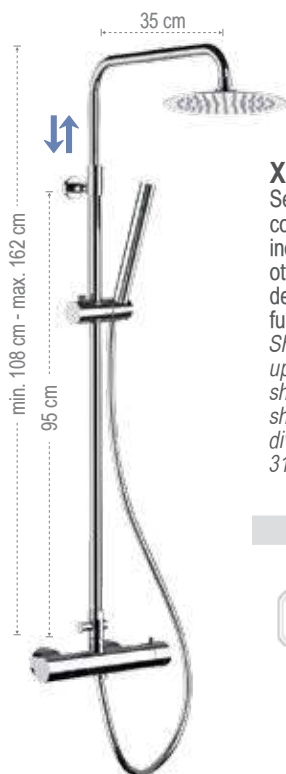

X37A7MCUFM20

Set doccia composto da: miscelatore esterno con attacco superiore, soffione in acciaio inox Ø 20 cm 357UFM20X, colonna doccia in ottone telescopica, altezza asta regolabile, con deviatore 330A, doccetta minimale in ottone, 1 funzione 317MM, flessibile 150 cm.

Shower set including: exposed mixer with upper connection, stainless steel Ø 20cm shower head 357UFM20X, telescopic brass shower column, with height-adjustable rod, with diverter 330A, 1-function brass hand shower 317MM, 150 cm flexible hose.

CR





X37A7MMUFM20

ATELIER

CHRONO

CELEBRITY

ELEMENT

Q DESIGN

X-STYLE

MISCELATORI A 2/3/4/5 VIE CON VITONE CERAMICO
2, 3, 4 OR 5-WAY MIXER WITH CERAMIC HEADVALVE

SOLO PARTE ESTERNA - EXPOSED COMPONENTS ONLY:

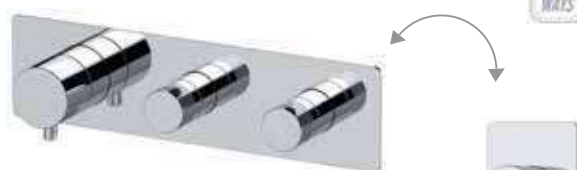

N98D2WB

Miscelatore a incasso a 2 vie per vasca o doccia con deviatori singoli a vitone ceramico. Per azionare l'uscita desiderata, ruotare la manopola del deviatore corrispondente. Parte a incasso unica, installazione possibile sia in orizzontale che in verticale.

2-way built-in mixer for bath or shower with single ceramic valve diverters. To open the desired water outlet, turn the knob of the corresponding diverter. Single recessed part, installation possible both horizontally and vertically.

CR

FIN 1

FIN 2

SOLO PARTE ESTERNA - EXPOSED COMPONENTS ONLY:



N98D2PWB

Miscelatore a incasso a 2 vie per vasca o doccia con deviatori singoli a vitone ceramico. Per azionare l'uscita desiderata, ruotare la manopola del deviatore corrispondente. Parte a incasso unica, installazione possibile sia in orizzontale che in verticale.

2-way built-in mixer for bath or shower with single ceramic valve diverters. To open the desired water outlet, turn the knob of the corresponding diverter. Single recessed part, installation possible both horizontally and vertically.

CR

FIN 1

FIN 2

SOLO PARTE INTERNA - BUILT-IN COMPONENTS ONLY:

WBOX98D2

pag 313

SOLO PARTE INTERNA - BUILT-IN COMPONENTS ONLY:

WBOX98D2

pag 313

SOLO PARTE ESTERNA - EXPOSED COMPONENTS ONLY:



N98D3WB

Miscelatore a incasso a 3 vie per vasca o doccia con deviatori singoli a vitone ceramico. Per azionare l'uscita desiderata, ruotare la manopola del deviatore corrispondente. Parte a incasso unica, installazione possibile sia in orizzontale che in verticale.

3-way built-in mixer for bath or shower with single ceramic valve diverters. To open the desired water outlet, turn the knob of the corresponding diverter. Single recessed part, installation possible both horizontally and vertically.

CR

FIN 1

FIN 2

SOLO PARTE ESTERNA - EXPOSED COMPONENTS ONLY:



N98D3PWB

Miscelatore a incasso a 3 vie per vasca o doccia con deviatori singoli a vitone ceramico. Per azionare l'uscita desiderata, ruotare la manopola del deviatore corrispondente. Parte a incasso unica, installazione possibile sia in orizzontale che in verticale.

3-way built-in mixer for bath or shower with single ceramic valve diverters. To open the desired water outlet, turn the knob of the corresponding diverter. Single recessed part, installation possible both horizontally and vertically.

CR

FIN 1

FIN 2

SOLO PARTE INTERNA - BUILT-IN COMPONENTS ONLY:

WBOX98D3

pag 313

SOLO PARTE INTERNA - BUILT-IN COMPONENTS ONLY:

WBOX98D3

pag 313

SOLO PARTE ESTERNA - EXPOSED COMPONENTS ONLY:



N98D4WB

Miscelatore a incasso a 4 vie per vasca o doccia con deviatori singoli a vitone ceramico. Per azionare l'uscita desiderata, ruotare la manopola del deviatore corrispondente. Parte a incasso unica, installazione possibile sia in orizzontale che in verticale.

4-way built-in mixer for bath or shower with single ceramic valve diverters.

To open the desired water outlet, turn the knob of the corresponding diverter. Single recessed part, installation possible both horizontally and vertically.

SOLO PARTE ESTERNA - EXPOSED COMPONENTS ONLY:

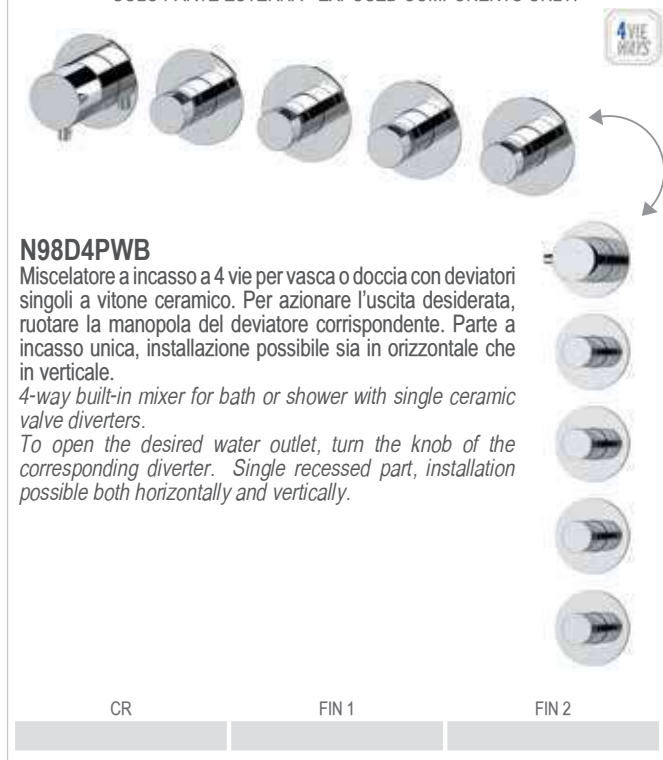

N98D4PWB

Miscelatore a incasso a 4 vie per vasca o doccia con deviatori singoli a vitone ceramico. Per azionare l'uscita desiderata, ruotare la manopola del deviatore corrispondente. Parte a incasso unica, installazione possibile sia in orizzontale che in verticale.

4-way built-in mixer for bath or shower with single ceramic valve diverters.

To open the desired water outlet, turn the knob of the corresponding diverter. Single recessed part, installation possible both horizontally and vertically.

SOLO PARTE INTERNA - BUILT-IN COMPONENTS ONLY:

WBOX98D4

> pag 314

SOLO PARTE INTERNA - BUILT-IN COMPONENTS ONLY:

WBOX98D4

> pag 314

SOLO PARTE ESTERNA - EXPOSED COMPONENTS ONLY:



N98D5WB

Miscelatore a incasso a 5 vie per vasca o doccia con deviatori singoli a vitone ceramico. Per azionare l'uscita desiderata, ruotare la manopola del deviatore corrispondente. Parte a incasso unica, installazione possibile sia in orizzontale che in verticale.

5-way built-in mixer for bath or shower with single ceramic valve diverters. To open the desired water outlet, turn the knob of the corresponding diverter. Single recessed part, installation possible both horizontally and vertically.

SOLO PARTE ESTERNA - EXPOSED COMPONENTS ONLY:

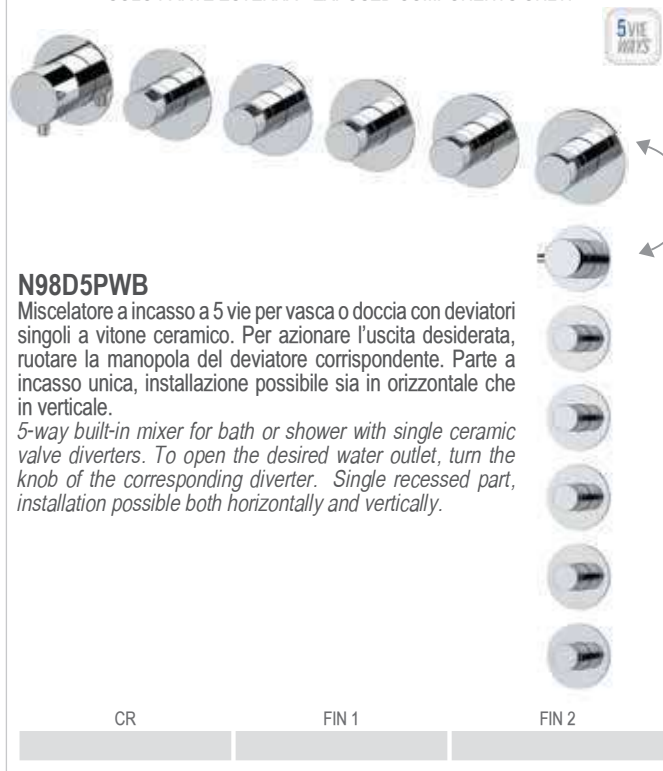

N98D5PWB

Miscelatore a incasso a 5 vie per vasca o doccia con deviatori singoli a vitone ceramico. Per azionare l'uscita desiderata, ruotare la manopola del deviatore corrispondente. Parte a incasso unica, installazione possibile sia in orizzontale che in verticale.

5-way built-in mixer for bath or shower with single ceramic valve diverters. To open the desired water outlet, turn the knob of the corresponding diverter. Single recessed part, installation possible both horizontally and vertically.

SOLO PARTE INTERNA - BUILT-IN COMPONENTS ONLY:

WBOX98D5

> pag 314

SOLO PARTE INTERNA - BUILT-IN COMPONENTS ONLY:

WBOX98D5

> pag 314

METRICA

IL CARATTERE DISTINTIVO NELL'EVOLUZIONE PROGETTUALE
THE DISTINCTIVE CHARACTER IN DESIGNING EVOLUTION



METRICA è una collezione di rubinetteria monocomando ideale per un ambiente moderno e accattivante. Il particolare design della leva di miscelazione dona stile e personalità all'intera figura. La collezione si sviluppa su una cartuccia dal diametro di 25mm, 35mm per le figure a incasso.

METRICA is a collection of single-lever taps, perfect for a modern an attractive interior. The special design of the mixing lever adds style and personality to the entire figure. The collection is developed on a 25mm diameter cartridge, 35mm for the built-in items.



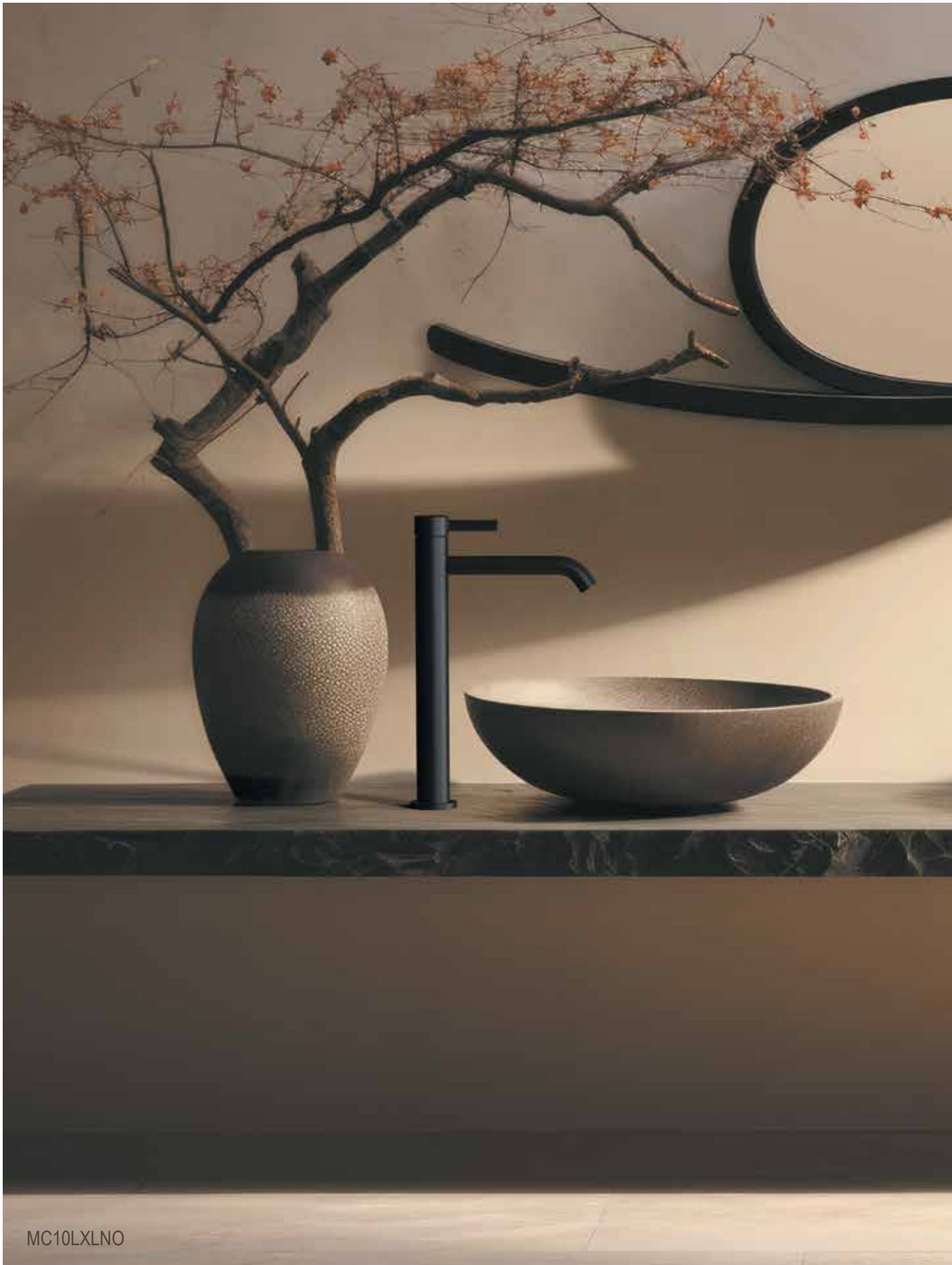

MC10LXLNO

METRICA





MC53D2WBNO



MC15PBO

OPZIONI DI FINITURA - FINISHING OPTIONS

CR		FIN 1		FIN 2	
	cromo chrome		nero opaco matt black		cromo nero spazzolato brushed black chrome
	CR		bianco opaco matt white		oro spazzolato brushed gold
			visual inox visual steel		oro lucido shiny gold
			oil bronze oil bronze		rame spazzolato brushed copper
			NO		CFP
			BO		BG
			XV		DO
			BR		RP

MISCELATORI LAVABO - WASHBASIN MIXERS



MC10
Miscelatore monocomando per lavabo, con scarico.
Single-lever basin mixer, with pop-up waste.



MC10ACC
Miscelatore monocomando per lavabo, modello "A" altezza media, con scarico click-clack con troppo-pieno incluso.
Single-lever basin mixer, model "A" medium height, click-clack waste with overflow included.



MC10LXL
Miscelatore monocomando alto per lavabo, misura XL, scarico click-clack con troppo-pieno incluso.
High single-lever washbasin mixer, XL size, click-clack waste with overflow included.



MC12
Miscelatore monocomando per lavabo, senza scarico e senza foro posteriore sul corpo.
Single-lever basin mixer, without waste and without rear body hole.



MC12A
Miscelatore monocomando per lavabo, modello "A" altezza media, senza scarico e senza foro sul corpo.
Single-lever basin mixer, model "A" medium height, without pop-up waste and with no rear hole.

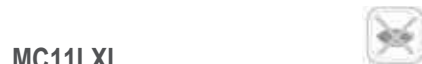

MC11LXL
Miscelatore monocomando alto per lavabo, misura XL, scarico non incluso.
High single-lever washbasin mixer, XL size, waste not included.



MC57
Miscelatore monocomando per lavabo a due fori. Scarico non incluso.
2-holes single-lever basin mixer. Waste not included.

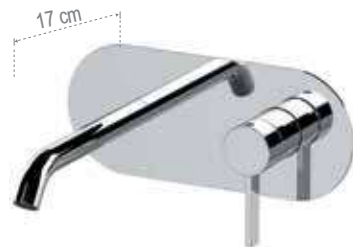

MC15
Miscelatore monocomando a incasso per lavabo. Piastra ultra-piatta. Lunghezza bocca 17 cm.
Single-lever built-it basin mixer. Ultra-flat plate. Spout length 17 cm.



MC15P
Miscelatore monocomando a incasso per lavabo, su due piastre tonde separate. Lunghezza bocca 17 cm.
Built-in single-lever basin mixer on two separate round plates. Spout length 17 cm.



MC57L
Miscelatore monocomando per lavabo a due fori, con bocca L, altezza 33cm. Scarico non incluso.
2-holes single-lever basin mixer, with L spout, height 33cm. Waste not included.



MC15L
Miscelatore monocomando a incasso per lavabo. Piastra ultra-piatta. Lunghezza bocca 19 cm.
Single-lever built-it basin mixer. Ultra-flat plate. Spout length 19 cm.



MC15PL
Miscelatore monocomando a incasso per lavabo, su due piastre tonde separate. Lunghezza bocca 19 cm.
Built-in single-lever basin mixer on two separate round plates. Spout length 19 cm.



BOCCHIE - SPOUTS



MC18

Miscelatore monocomando per lavabo, modello "A" altezza media, con scarico click-clack con troppo-pieno incluso. Prodotto completo.
Single-lever basin mixer, model "A" medium height, click-clack waste with overflow included. Complete product.

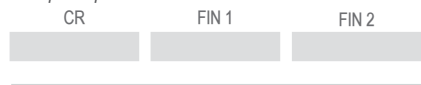

Q08FIS2

Solo parte interna.
Built-in components only.



MC18E

Solo parti esterne.
Exposed components only.

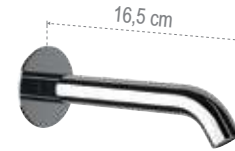
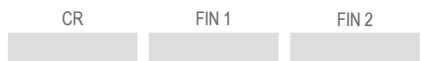

91X

Bocca incasso per miscelatore vasca/doccia.
Built-in spout for bath/shower mixer.

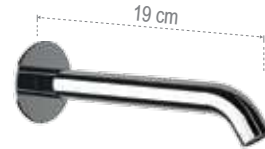
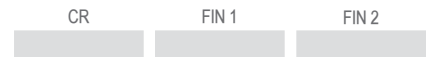

91XL

Bocca incasso per miscelatore vasca/doccia, 19cm
Built-in spout for bath/shower mixer, 19cm

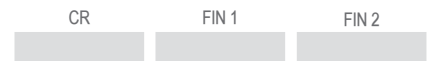

LAVABO A MURO CON BOX INCASSO - WALL WASHBASIN MIXER WITH BUILT-IN BOX



SOLO PARTE ESTERNA - EXPOSED COMPONENTS ONLY:

MC15WB

Parti esterne per miscelatore monocomando a incasso per lavabo da abbinare al box incasso (non incluso). Piastra ultra-piatta. Lunghezza bocca 17 cm.
Exposed components for single-lever built-in basin mixer, with ultra-flat wall plate. To match with the built-in box (not included). Spout length 17 cm.



MC15LWB

Idem sopra, con lunghezza bocca 19 cm.
Same as above, with spout length 19 cm.

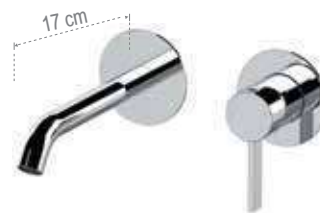

SOLO PARTE ESTERNA - EXPOSED COMPONENTS ONLY:

MC15PWB

Parti esterne per miscelatore monocomando a incasso per lavabo da abbinare al box incasso (non incluso). Su due piastre tonde separate. Lunghezza bocca 17 cm.
Exposed components for single-lever built-in basin mixer, with two separate round plates. To match with the built-in box (not included). Spout length 17 cm.



MC15PLWB

Idem sopra, con lunghezza bocca 19 cm.
Same as above, with spout length 19 cm.



SOLO PARTE INTERNA - BUILT-IN COMPONENTS ONLY:

WBOX15

SOLO PARTE INTERNA - BUILT-IN COMPONENTS ONLY:

WBOX15



MISCELATORI BIDET - BIDET MIXERS



MC20
Miscelatore monocomando per bidet, con scarico.
Single-lever bidet mixer, with pop-up waste.



MC22
Miscelatore monocomando per bidet, senza scarico e senza foro posteriore.
Single-lever bidet mixer, without waste and without rear hole.



MC65W
Set shut-off comprensivo di: miscelatore a incasso con supporto doccia/presa acqua, doccetta a pulsante (332OW), tutto in ottone. Flessibile doccia cm 120.
Shut-off set including: built-in mixer with shower holder/water punch on flange, shut-off hand shower (332OW), all in brass. Flexible hose cm 120.



MISCELATORI ESTERNI PER VASCA E DOCCIA - EXPOSED MIXERS FOR BATH AND SHOWER



MC02

Miscelatore monocomando per vasca, con kit doccia in ottone ad 1 funzione. Flessibile 150cm.
 Wall mounted single-lever bath mixer with 1-function brass hand shower kit. 150cm flexible hose.

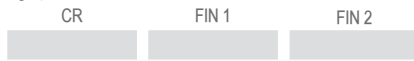

MC05

Miscelatore monocomando per vasca, senza kit doccia.
 Wall mounted single-lever bath mixer, without shower kit.

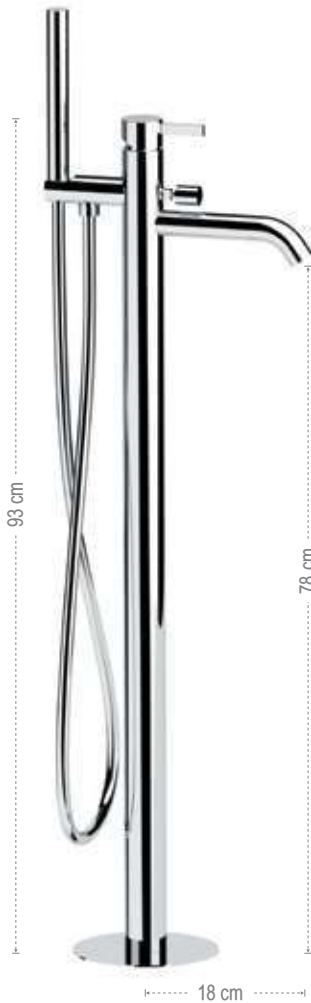
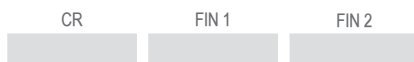

MC08

Miscelatore bordo vasca da pavimento, con deviatore e kit doccia in ottone. Prodotto completo.
 Floor mounting single-lever bath mixer, with diverter and brass hand shower kit. Complete product.



Q08FIS2

Solo parte interna.
 Built-in CR components only.



MC08E

Solo parti esterne.
 Exposed components only.

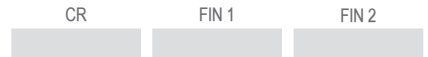

MC027MD

Miscelatore monocomando per vasca, con kit doccia in ABS ad 1 funzione e getti in silicone. Flessibile 150cm.
 Wall mounted single-lever bath mixer with 1-function ABS hand shower kit with jets in silicone. 150cm flexible hose.



MC38

Miscelatore monocomando esterno per doccia, con kit doccia in ottone ad 1 funzione. Flessibile 150cm.
 Wall mounted exposed single-lever shower mixer with 1-function brass hand shower kit. 150cm flexible hose.



MC33

Miscelatore monocomando esterno per doccia, senza kit doccia.
 Wall mounted exposed single-lever shower mixer, without shower kit.



MISCELATORI A INCASSO PER VASCA - BUILT-IN MIXERS FOR BATH



2 VIE
WAYS



SOLO PARTE ESTERNA - EXPOSED COMPONENTS ONLY:

MC53D2PWB

Set a incasso a 2 vie per vasca su piastre tonde separate.
2-way built-in set for bathtub on separate round plates.

CR FIN 1 FIN 2



SOLO PARTE INTERNA - BUILT-IN COMPONENTS ONLY:

WBOX97D2

> pag 304



SOLO PARTE ESTERNA - EXPOSED COMPONENTS ONLY:

MC53D2WB

Set a incasso a 2 vie per vasca su piastra unica rettangolare.
2-way built-in set for bathtub on a single rectangular plate

CR FIN 1 FIN 2



SOLO PARTE INTERNA - BUILT-IN COMPONENTS ONLY:

WBOX97D2

> pag 304



2 VIE
WAYS



SOLO PARTE ESTERNA - EXPOSED COMPONENTS ONLY:

MC54D2PWB

Set miscelatore a incasso a 2 vie per vasca/doccia su 3 piastre tonde. Da completare con la seconda uscita acqua.
2-way built-in mixer set for bathtub / shower on 3 round plates. To be completed with the second water outlet.

CR FIN 1 FIN 2



SOLO PARTE INTERNA - BUILT-IN COMPONENTS ONLY:

WBOX97D2

> pag 304



SOLO PARTE ESTERNA - EXPOSED COMPONENTS ONLY:

MC54D2WB

Set miscelatore a incasso a 2 vie per vasca/doccia su piastra unica rettangolare. Da completare con la seconda uscita.
2-way built-in mixer set for bathtub / shower on single rectangular plate. To be completed with the second water outlet.

CR FIN 1 FIN 2

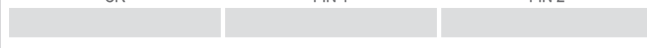

SOLO PARTE INTERNA - BUILT-IN COMPONENTS ONLY:

WBOX97D2

> pag 304



3 VIE
WAYS



SOLO PARTE ESTERNA - EXPOSED COMPONENTS ONLY:

MC54D3PWB

Set miscelatore a incasso a 3 vie per vasca/doccia su 3 piastre tonde. Da completare con la seconda e la terza uscita acqua.
3-way built-in mixer set for bathtub / shower on 3 separate round plates. To be completed with the second and the third water outlet.

CR FIN 1 FIN 2



SOLO PARTE INTERNA - BUILT-IN COMPONENTS ONLY:

WBOX97D3

> pag 308



SOLO PARTE ESTERNA - EXPOSED COMPONENTS ONLY:

MC54D3WB

Set miscelatore a incasso a 3 vie per vasca/doccia su piastra unica rettangolare. Da completare con la seconda e la terza uscita acqua.
3-way built-in mixer set for bathtub / shower on single rectangular plate. To be completed with the second and the third water outlet.

CR FIN 1 FIN 2

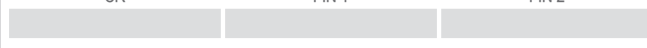

SOLO PARTE INTERNA - BUILT-IN COMPONENTS ONLY:

WBOX97D3

> pag 308

Set doccia acquistabile separatamente a pagina 427 - Shower set can be purchased separately on page 427

MISCELATORI A INCASSO PER DOCCIA - BUILT-IN MIXERS FOR SHOWER

1 VIA WAY



MC30L

Miscelatore a incasso per doccia, su piastra tonda ultra-piatta.
Built-in shower mixer, ultra-flat round wall plate.

CR FIN 1 FIN 2



MC30Q

Miscelatore a incasso per doccia, su piastra quadrata ultra-piatta.
Built-in shower mixer, ultra-flat square wall plate.

CR FIN 1 FIN 2

2 VIE WAYS



MC09L

Miscelatore a incasso per vasca/doccia con deviatore a pressione, su piastra tonda ultra-piatta.
Built-in bath/shower mixer with push button diverter, on ultra-flat round wall plate.

CR FIN 1 FIN 2



MC09Q

Miscelatore a incasso per vasca/doccia con deviatore a pressione, su piastra quadrata ultra-piatta.
Built-in bath/shower mixer with push button diverter, on ultra-flat square wall plate.

CR FIN 1 FIN 2

N09B

Solo parte interna.
Built-in components only.



CR FIN 1 FIN 2

MC09LE

Solo parte esterna.
Exposed components only.

CR FIN 1 FIN 2

N09B

Solo parte interna.
Built-in components only.



CR FIN 1 FIN 2

MC09QE

Solo parte esterna.
Exposed components only.

CR FIN 1 FIN 2

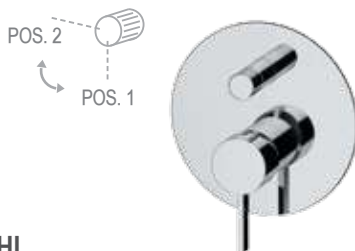

MC09HL

Miscelatore a incasso per vasca/doccia con deviatore a 2 vie a vitone ceramico. Per selezionare l'uscita desiderata, la manopola del deviatore deve essere ruotata da una posizione all'altra.
Built-in bath/shower mixer with 2-way diverter with ceramic head valve. To select the desired output, the diverter knob must be turned from one position to the other.

CR FIN 1 FIN 2

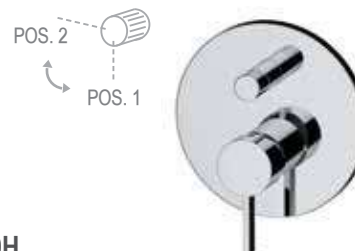

MC09H

Miscelatore a incasso per vasca/doccia con deviatore a 2 vie a vitone ceramico, su piastra tonda. Per selezionare l'uscita desiderata, la manopola del deviatore deve essere ruotata da una posizione all'altra.
Built-in bath/shower mixer with 2-way diverter with ceramic head valve, on round wall plate. To select the desired output, the diverter knob must be turned from one position to the other.

CR FIN 1 FIN 2

N09HB

Solo parte interna.
Built-in components only.



CR FIN 1 FIN 2

MC09LE

Solo parte esterna.
Exposed components only.

CR FIN 1 FIN 2

N09HB

Solo parte interna.
Built-in components only.



CR FIN 1 FIN 2

MC09E

Solo parte esterna.
Exposed components only.

CR FIN 1 FIN 2

METRICA

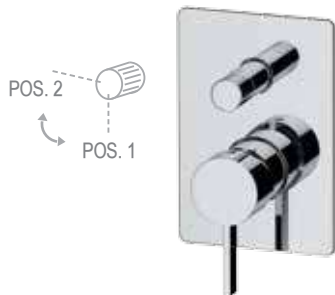

2 VIE WAYS

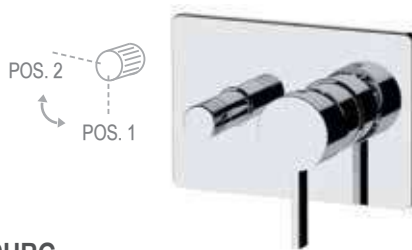

2 VIE WAYS

MC09HG

Miscelatore a incasso per vasca/doccia con deviatore a 2 vie a vitone ceramico. Per selezionare l'uscita desiderata, la manopola del deviatore deve essere ruotata da una posizione all'altra.
Built-in bath/shower mixer with 2-way diverter with ceramic head valve. To select the desired output, the diverter knob must be turned from one position to the other.



MC09HRG

Miscelatore a incasso per vasca/doccia con deviatore a 2 vie con vitone ceramico, su piastra rettangolare, installazione orizzontale. Per selezionare l'uscita desiderata, la manopola del deviatore deve essere ruotata da una posizione all'altra.
Built-in bath/shower mixer with 2-way diverter with ceramic head valve, on rectangular plate, horizontal mounting. To select the desired output, the diverter knob must be turned from one position to the other.



N09HB

Solo parte interna.
Built-in components only.



MC09GE

Solo parte esterna.
Exposed components only.



N09HRB

Solo parte interna.
Built-in components only.



MC09GE

Solo parte esterna.
Exposed components only.



2 VIE WAYS

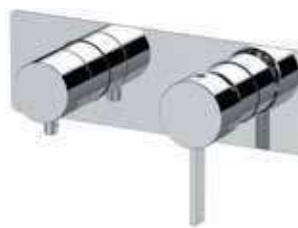

2 VIE WAYS

SOLO PARTE ESTERNA - EXPOSED COMPONENTS ONLY:

MC92ZPWB

Miscelatore a incasso per vasca/doccia con deviatore a 2 vie di tipo meccanico, su due piastre tonde.
Built-in bath/shower mixer with 2-way mechanical diverter, on two round plates.

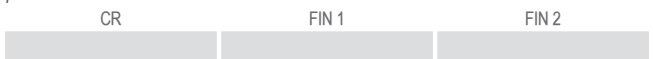

SOLO PARTE ESTERNA - EXPOSED COMPONENTS ONLY:

MC92ZWB

Miscelatore a incasso per vasca/doccia con deviatore a 2 vie di tipo meccanico, su piastra rettangolare.
Built-in bath/shower mixer with 2-way mechanical diverter, on rectangular plate.



SOLO PARTE INTERNA - BUILT-IN COMPONENTS ONLY:

WBOX92Z

> pag 300

SOLO PARTE INTERNA - BUILT-IN COMPONENTS ONLY:

WBOX92Z

> pag 300



2 VIE WAYS



2 VIE WAYS

SOLO PARTE ESTERNA - EXPOSED COMPONENTS ONLY:

MC97D2PWB

Set miscelatore a incasso a 2 vie per vasca/doccia su 3 piastre tonde. Da completare con la seconda uscita.
2-way built-in shower mixer set on 3 round plates. To be completed with the second water outlet.

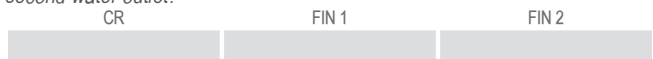

SOLO PARTE ESTERNA - EXPOSED COMPONENTS ONLY:

MC97D2WB

Set miscelatore a incasso a 2 vie per vasca/doccia su piastra rettangolare. Da completare con la seconda uscita.
2-way built-in shower mixer set on rectangular plate. To be completed with the second water outlet.

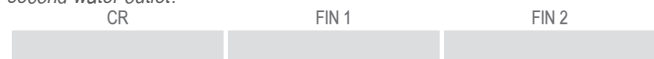

SOLO PARTE INTERNA - BUILT-IN COMPONENTS ONLY:

WBOX97D2

> pag 304

SOLO PARTE INTERNA - BUILT-IN COMPONENTS ONLY:

WBOX97D2

> pag 304

3 VIE WAYS



SOLO PARTE ESTERNA - EXPOSED COMPONENTS ONLY:

MC93ZPWB

Miscelatore a incasso per vasca/doccia con deviatore a 3 vie di tipo meccanico, su due piastre tonde.

Built-in bath/shower mixer with 3-way mechanical diverter, on two round plates.

CR

FIN 1

FIN 2

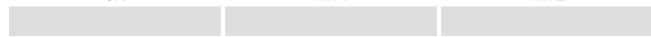

SOLO PARTE INTERNA - BUILT-IN COMPONENTS ONLY:

WBOX93Z

pag 302

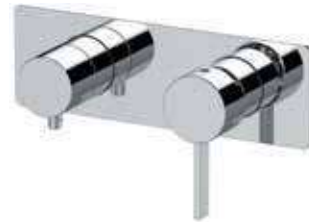

SOLO PARTE ESTERNA - EXPOSED COMPONENTS ONLY:

MC93ZWB

Miscelatore a incasso per vasca/doccia con deviatore a 3 vie di tipo meccanico, su piastra rettangolare.

Built-in bath/shower mixer with 3-way mechanical diverter, on rectangular plate.

CR

FIN 1

FIN 2

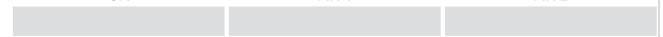

SOLO PARTE INTERNA - BUILT-IN COMPONENTS ONLY:

WBOX93Z

pag 302

3 VIE WAYS



SOLO PARTE ESTERNA - EXPOSED COMPONENTS ONLY:

MC97D3PWB

Set miscelatore a incasso a 3 vie per vasca/doccia su 3 piastre tonde. Da completare con la seconda e la terza uscita acqua.

3-way built-in bath/shower mixer set on 3 round plates. To be completed with the second and the third water outlet.

CR

FIN 1

FIN 2

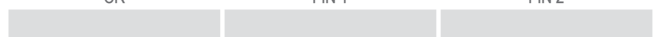

SOLO PARTE INTERNA - BUILT-IN COMPONENTS ONLY:

WBOX97D3

pag 308



SOLO PARTE ESTERNA - EXPOSED COMPONENTS ONLY:

MC97D3WB

Set miscelatore a incasso a 3 vie per vasca/doccia su piastra rettangolare. Da completare con la seconda e la terza uscita acqua.

3-way built-in shower mixer set on rectangular plate. To be completed with the second and the third water outlet.

CR

FIN 1

FIN 2

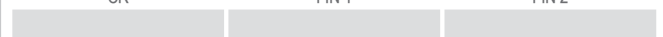

SOLO PARTE INTERNA - BUILT-IN COMPONENTS ONLY:

WBOX97D3

pag 308

ENERGY

PIÙ ENERGIA AL TUO STILE D'ARREDO
MORE ENERGY TO YOUR FURNISHING STYLE



La collezione di miscelatori monocomando ENERGY è una soluzione di rubinetteria versatile e moderna. Il design di ENERGY coniuga in modo armonioso raggature morbide con superfici piatte e profilate. La fusione in ottone include la sagoma dell'aeratore che scompare così al suo interno senza interrompere la continuità visiva del miscelatore. La serie è dotata di cartuccia a dischi ceramici Ø 35 mm.

The ENERGY single-lever mixers collection is a versatile and modern faucet solution. The design of ENERGY harmoniously combines soft curvings with flat profiled surfaces. The brass shape includes the outlet shape of the aerator, which this disappears inside without interrupting the visual continuity of the mixer. The series is equipped with a Ø 35 mm ceramic disc cartridge.





EY10L

ENERGY



EY53D2WB



EY10LNO

EY12NO

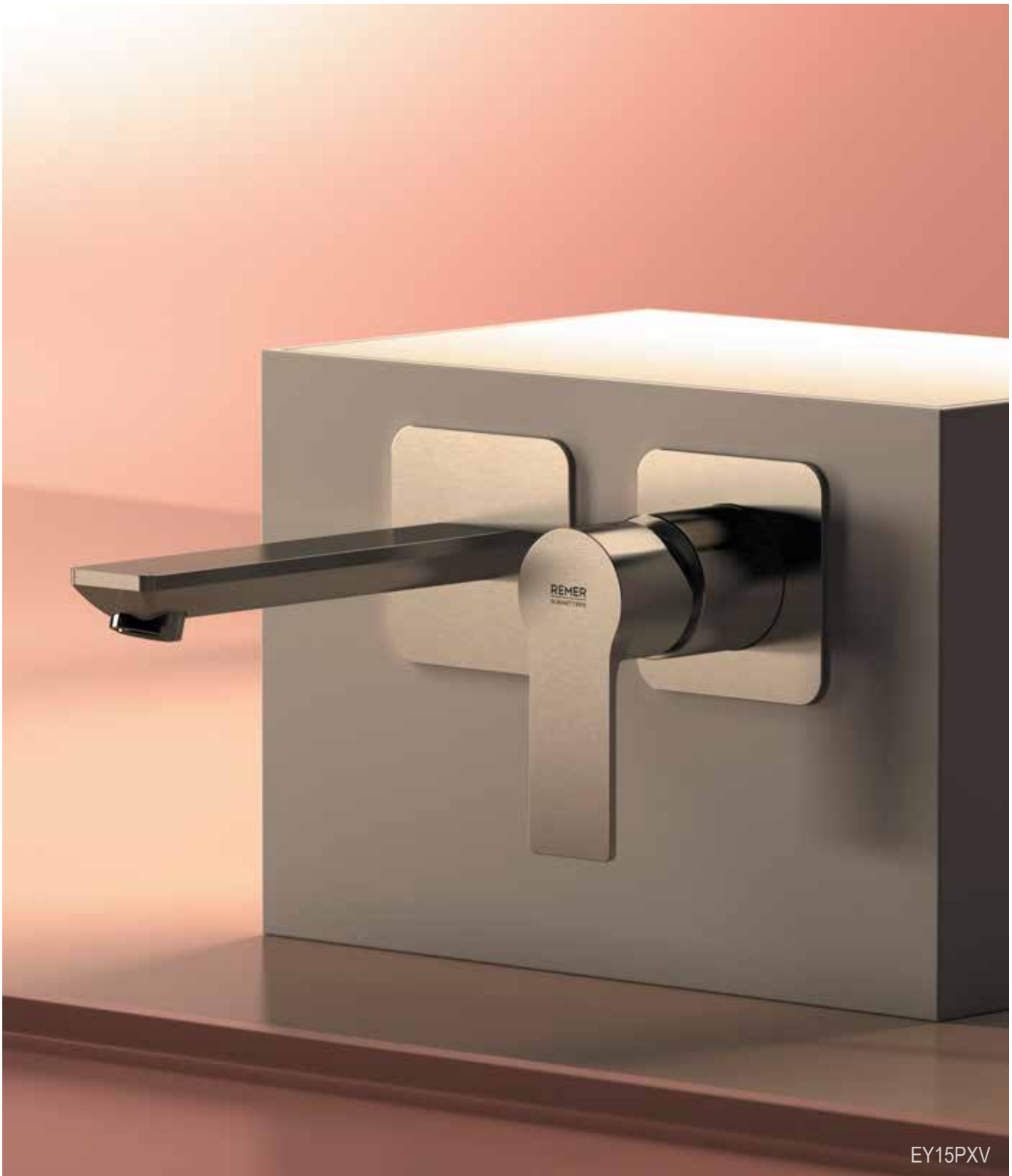

EY15PXV

OPZIONI DI FINITURA - FINISHING OPTIONS

CR	FIN 1	FIN 2
 <p>cromo chrome</p> <p>CR</p>	 <p>nero opaco matt black</p> <p>NO</p>  <p>bianco opaco matt white</p> <p>BO</p>  <p>visual inox visual steel</p> <p>XV</p>	

MISCELATORI LAVABO - WASHBASIN MIXERS



EY10
Miscelatore monocomando lavabo, con scarico.
Single-lever basin mixer, with pop-up waste.



EY10ACC
Miscelatore monocomando per lavabo, modello "A" altezza media, scarico click-clack con troppo-pieno incluso.
Single-lever basin mixer, model "A" medium height, click-clack waste with overflow included.



EY10L
Miscelatore monocomando lavabo alto L, con scarico click-clack con troppo-pieno.
Single-lever high L basin mixer, with click-clack waste and overflow.



EY11
Miscelatore monocomando lavabo, senza scarico.
Single-lever basin mixer, without waste.



EY12A
Miscelatore monocomando per lavabo, modello "A" altezza media, senza scarico e senza foro sul corpo.
Single-lever basin mixer, model "A" medium height, without pop-up waste and with no rear hole.



EY11L
Miscelatore monocomando lavabo alto L, senza scarico.
Single-lever high L basin mixer, without waste.



EY12
Miscelatore monocomando lavabo, senza scarico e senza foro sul corpo.
Single-lever basin mixer, without waste and without body hole.



EY15
Miscelatore monocomando a incasso per lavabo, con piastra orizzontale in ottone.
Single-lever built-in basin mixer, with wall plate in brass.



EY15P
Miscelatore monocomando a incasso per lavabo, su due piastre quadre separate.
Built-in single-lever basin mixer on two separate square plates.



EY57
Miscelatore monocomando lavabo due fori, senza scarico.
2-holes single-lever washbasin mixer, without waste.



EY15L
Miscelatore monocomando a incasso per lavabo, con piastra orizzontale in ottone, lunghezza bocca 23 cm.
Single-lever built-in basin mixer, with wall plate in brass, spout length 23 cm.



EY15PL
Miscelatore monocomando a incasso per lavabo, su due piastre quadre separate. Lunghezza bocca 23 cm.
Built-in single-lever basin mixer on two separate square plates. Spout length 23 cm.



EY57L
Miscelatore monocomando per lavabo a due fori, con bocca L, altezza 33cm. Scarico non incluso.
2-holes single-lever basin mixer, with L spout, height 33cm. Waste not included.



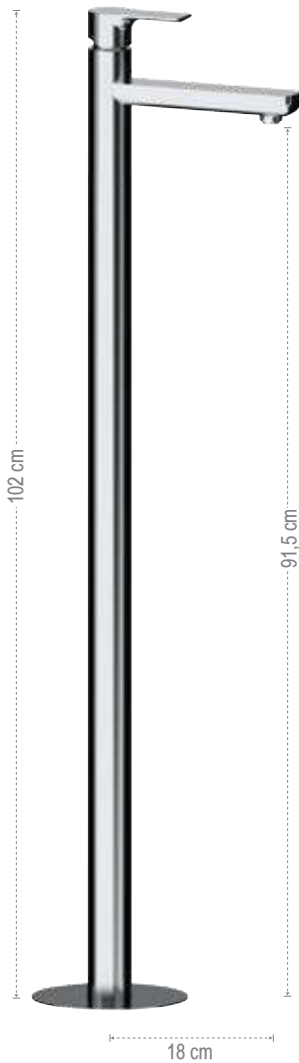

EY18

Miscelatore monocomando lavabo da terra con scarico click-clack con troppo-pieno. Prodotto completo.
Single-lever mixer for floor mounting with click-clack waste and overflow. Complete product.

CR

FIN 1



Q08FIS2

Solo parte interna.
Built-in components only.

CR

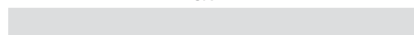

EY18E

Solo parti esterne.
Exposed components only.

CR

FIN 1



EY72C

Miscelatore monocomando per lavello, serie ENERGY con canna corta a "U", tipo lusso.
Single-lever one-hole sink mixer, ENERGY series with short "U" spout, luxury type.

CR

FIN 1



EY72

Miscelatore monocomando monoforo 90°, con canna alta girevole.
Single-lever sink mixer 90°, high swivel spout.

CR

FIN 1



LAVABO A MURO CON BOX INCASSO - WALL WASHBASIN MIXER WITH BUILT-IN BOX



SOLO PARTE ESTERNA - EXPOSED COMPONENTS ONLY:

EY15WB

Parti esterne per miscelatore monocomando a incasso per lavabo da abbinare al box incasso (non incluso). Piastra ultra-piatta. Lunghezza bocca 18 cm.
Exposed components for single-lever built-in basin mixer, with ultra-flat wall flange. To match with the built-in box (not included). Spout length 18 cm.

CR

FIN 1



EY15LWB

Idem sopra, con lunghezza bocca 23 cm.
Same as above, with spout length 23 cm.

CR

FIN 1



SOLO PARTE ESTERNA - EXPOSED COMPONENTS ONLY:

EY15PWB

Parti esterne per miscelatore monocomando a incasso per lavabo da abbinare al box incasso (non incluso). Su due piastre quadrate separate. Lunghezza bocca 18 cm.
Exposed components for single-lever built-in basin mixer, with two separate square plates. To match with the built-in box (not included). Spout length 18 cm.

CR

FIN 1



EY15PLWB

Idem sopra, con lunghezza bocca 23 cm.
Same as above, with spout length 23 cm.

CR

FIN 1



SOLO PARTE INTERNA - BUILT-IN COMPONENTS ONLY:

WBOX15

SOLO PARTE INTERNA - BUILT-IN COMPONENTS ONLY:

WBOX15

BOCCHIE - SPOUTS



91EY
Bocca incasso.
Built-in spout.

CR

FIN 1

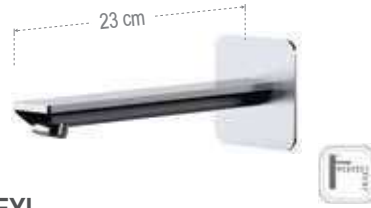

91EYL
Bocca incasso, 23 cm.
Built-in spout, 23 cm.

CR

FIN 1

MISCELATORI BIDET - BIDET MIXERS



EY20
Miscelatore monocomando bidet, con scarico.
Single-lever bidet mixer, with pop-up waste.

CR

FIN 1



EY65W
Miscelatore incasso per shut-off con supporto doccia/presa acqua integrato, attacco conico da 1/2", con doccetta shut-off e flessibile cm 120.
Built-in shower mixer with integrated shower holder/water punch on flange, with 1/2 connection, with shut-off and flexible hose cm 120.

CR

FIN 1



EYC31DP
Miscelatore monocomando esterno doccia, interasse 100 mm, con doccetta shut-off e flessibile cm 120.
Wall mounted single lever shower mixer, interaxis 100 mm, including shut-off and flexible hose cm 120.

CR



EY21
Miscelatore monocomando bidet, senza scarico.
Single-lever bidet mixer, without waste.

CR

FIN 1



EY65B
Miscelatore incasso per shut-off con supporto doccia/presa acqua integrato, attacco conico da 1/2", senza kit doccia.
Built-in shower mixer with integrated shower holder/water punch on flange, with 1/2 connection, without shower kit.

CR

FIN 1



EYC31
Miscelatore monocomando esterno doccia, interasse 100 mm, senza kit doccia.
Wall mounted single lever shower mixer, interaxis 100 mm, without shower kit.

CR

FIN 1

MISCELATORI ESTERNI PER VASCA E DOCCIA - EXPOSED MIXERS FOR BATH AND SHOWER



EY02
 Miscelatore vasca con deviatore integrato, con flessibile cm 150 e doccetta a 3 funzioni con pulsante cambio getti, anticalcare e supporto snodato.
Wall mounted bath mixer with integrated diverter, with flexible hose cm 150 and 3 functions antilime stone handshower with button to change jets and swivel shower holder.

CR



EY03
 Miscelatore monocomando per bordo vasca, con flessibile cm 150 e doccetta a 3 funzioni con pulsante cambio getti, getti in silicone anticalcare e supporto snodato.
Single lever bath mixer with diverter, with flexible cm 150 and 3 functions antilime stone handshower with button to change jets, silicon jets and swivel shower holder.

CR



EY38
 Miscelatore doccia con leva frontale con flessibile cm 150 e doccetta a 3 funzioni con pulsante cambio getti, anticalcare con supporto snodato.
Exposed shower mixer with frontal lever with flexible cm 150 and 3 functions with button to change jets, antilime stone handshower with silicon jets and swivel shower holder.

CR

EY05
 Miscelatore vasca con deviatore integrato, senza kit doccia.
Wall mounted bath mixer with integrated diverter, without shower kit.

CR

FIN 1

EY04
 Miscelatore monocomando per bordo vasca, senza kit doccia.
Single lever bath mixer with diverter, without shower kit.

CR

FIN 1

EY33
 Miscelatore doccia con leva frontale, senza kit doccia.
Exposed shower mixer with frontal lever, without shower kit.

CR

FIN 1

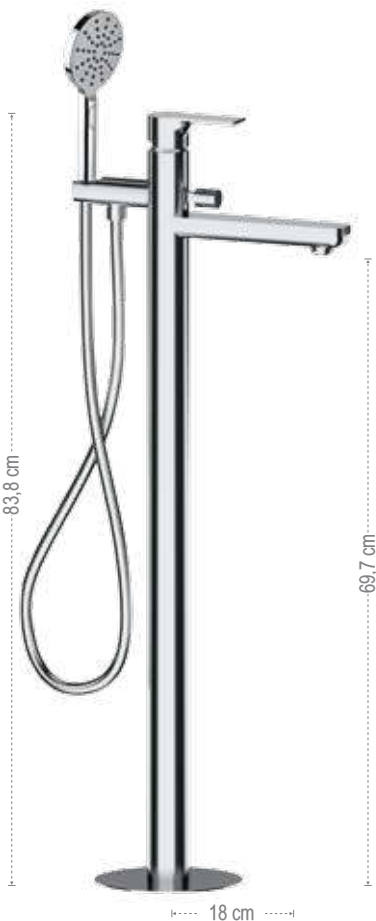

EY08
 Miscelatore vasca da pavimento, con deviatore e kit doccia con doccetta in ABS 4 funzioni con pulsante cambio getti, anticalcare e flessibile 150 cm, senza scarico. Prodotto completo.
Single-lever bath mixer floor mounting, with diverter and shower kit, 4 functions antilime stone handshower in ABS with button to change jets and flexible hose 150 cm, without waste. Complete product.

CR

FIN 1

Q08FIS2
 Solo parte interna.
Built-in components only.



CR

EY08E
 Solo parti esterne.
Exposed components only.

CR

FIN 1

MISCELATORI A INCASSO PER VASCA - BUILT-IN MIXERS FOR BATH

2 VIE
WAYS

SOLO PARTE ESTERNA - EXPOSED COMPONENTS ONLY:

EY53D2WB

Set a incasso a 2 vie per vasca su piastra unica rettangolare.
2-way built-in set for bathtub on a single rectangular plate.

CR

FIN 1



SOLO PARTE INTERNA - BUILT-IN COMPONENTS ONLY:

WBOX97D2

pag 304



SOLO PARTE ESTERNA - EXPOSED COMPONENTS ONLY:

EY53D2PWB

Set a incasso a 2 vie per vasca su piastre quadrate separate.
2-way built-in set for bathtub on separate square plates.

CR

FIN 1



SOLO PARTE INTERNA - BUILT-IN COMPONENTS ONLY:

WBOX97D2

pag 304

2 VIE
WAYS

SOLO PARTE ESTERNA - EXPOSED COMPONENTS ONLY:

EY54D2WB

Set miscelatore a incasso a 2 vie per vasca/doccia su piastra unica rettangolare. Da completare con la seconda uscita.
2-way built-in mixer set for bathtub / shower on single rectangular plate. To be completed with the second water outlet.

CR

FIN 1



SOLO PARTE INTERNA - BUILT-IN COMPONENTS ONLY:

WBOX97D2

pag 304



SOLO PARTE ESTERNA - EXPOSED COMPONENTS ONLY:

EY54D2PWB

Set miscelatore a incasso a 2 vie per vasca/doccia su 3 piastre quadrate. Da completare con la seconda uscita acqua.
2-way built-in mixer set for bathtub / shower on 3 square plates. To be completed with the second water outlet.

CR

FIN 1



SOLO PARTE INTERNA - BUILT-IN COMPONENTS ONLY:

WBOX97D2

pag 304

3 VIE
WAYS

SOLO PARTE ESTERNA - EXPOSED COMPONENTS ONLY:

EY54D3WB

Set miscelatore a incasso a 3 vie per vasca/doccia su piastra unica rettangolare. Da completare con la seconda e la terza uscita acqua.
3-way built-in mixer set for bathtub / shower on single rectangular plate. To be completed with the second and the third water outlet.

CR

FIN 1



SOLO PARTE INTERNA - BUILT-IN COMPONENTS ONLY:

WBOX97D3

pag 308



SOLO PARTE ESTERNA - EXPOSED COMPONENTS ONLY:

EY54D3PWB

Set miscelatore a incasso a 3 vie per vasca/doccia su 3 piastre quadrate. Da completare con la seconda e la terza uscita acqua.
3-way built-in mixer set for bathtub / shower on 3 separate square plates. To be completed with the second and the third water outlet.

CR

FIN 1



SOLO PARTE INTERNA - BUILT-IN COMPONENTS ONLY:

WBOX97D3

pag 308

Set doccia acquistabile separatamente a pagina 427 - Shower set can be purchased separately on page 427

MISCELATORI A INCASSO PER DOCCIA - *BUILT-IN MIXERS FOR SHOWER*



EY30
Miscelatore monocomando a incasso per doccia completo, con piastra tonda.
Complete single lever built-in shower mixer, round wall plate.



EY30L
Miscelatore monocomando incasso per doccia completo, con piastra rettangolare lusso.
Complete single lever built-in shower mixer, with deluxe rectangular plate.



EY09
Miscelatore monocomando a incasso con deviatore per vasca/doccia completo.
Complete single lever built-in bath/shower mixer with diverter, round wall plate.



EY09L
Miscelatore monocomando incasso con deviatore per vasca/doccia completo, con piastra rettangolare lusso.
Complete single lever built-in bath/shower mixer with diverter, with deluxe rectangular plate.



N09B
Solo parte interna.
Built-in components only.



EY09E
Solo parte esterna.
Exposed components only.



N09B
Solo parte interna.
Built-in components only.

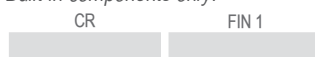

EY09LE
Solo parte esterna.
Exposed components only.



EY09H
Miscelatore a incasso per vasca/doccia con deviatore a 2 vie a vitone ceramico, su piastra tonda. Per selezionare l'uscita desiderata, la manopola del deviatore deve essere ruotata da una posizione all'altra.
Built-in bath/shower mixer with 2-way diverter with ceramic head valve, on round wall plate. To select the desired output, the diverter knob must be turned from one position to the other.



EY09HL
Miscelatore a incasso per vasca/doccia con deviatore a 2 vie a vitone ceramico. Per selezionare l'uscita desiderata, la manopola del deviatore deve essere ruotata da una posizione all'altra.
Built-in bath/shower mixer with 2-way diverter with ceramic head valve. To select the desired output, the diverter knob must be turned from one position to the other.



N09HB
Solo parte interna.
Built-in components only.



EY09E
Solo parte esterna.
Exposed components only.



N09HB
Solo parte interna.
Built-in components only.



EY09LE
Solo parte esterna.
Exposed components only.



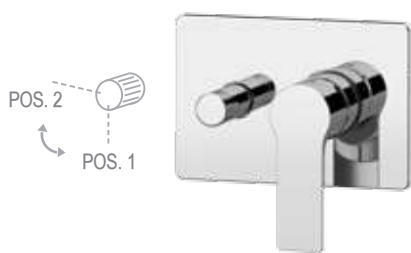

2 VIE WAYS

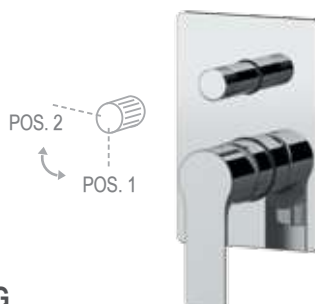

EY09HRG

Miscelatore a incasso per vasca/doccia con deviatore a 2 vie con vitone ceramico, su piastra rettangolare, montaggio orizzontale. Per selezionare l'uscita desiderata, la manopola del deviatore deve essere ruotata da una posizione all'altra.

Built-in bath/shower mixer with 2-way diverter with ceramic head valve, on rectangular plate, horizontal mounting. To select the desired output, the diverter knob must be turned from one position to the other.

CR FIN 1



EY09HG

Miscelatore a incasso per vasca/doccia con deviatore a 2 vie a vitone ceramico, su piastra rettangolare. Per selezionare l'uscita desiderata, la manopola del deviatore deve essere ruotata da una posizione all'altra.

Built-in bath/shower mixer with 2-way diverter with ceramic head valve, on rectangular wall plate. To select the desired output, the diverter knob must be turned from one position to the other.

CR FIN 1



N09HRB

Solo parte interna.
Built-in components only.



CR FIN 1



EY09GE

Solo parte esterna.
Exposed components only.

CR FIN 1



N09HB

Solo parte interna.
Built-in components only.



CR FIN 1



EY09GE

Solo parte esterna.
Exposed components only.

CR FIN 1



2 VIE WAYS

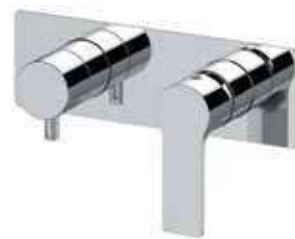

2 VIE WAYS

2 VIE WAYS

SOLO PARTE ESTERNA - EXPOSED COMPONENTS ONLY:

EY92ZPWB

Miscelatore a incasso per vasca/doccia con deviatore a 2 vie di tipo meccanico, su due piastre quadrate.

Built-in bath/shower mixer with 2-way mechanical diverter, on two square plates.

CR FIN 1



SOLO PARTE ESTERNA - EXPOSED COMPONENTS ONLY:

EY92ZWB

Miscelatore a incasso per vasca/doccia con deviatore a 2 vie di tipo meccanico, su piastra rettangolare.

Built-in bath/shower mixer with 2-way mechanical diverter, on rectangular plate.

CR FIN 1



SOLO PARTE INTERNA - BUILT-IN COMPONENTS ONLY:

WBOX92Z

pag 300

SOLO PARTE INTERNA - BUILT-IN COMPONENTS ONLY:

WBOX92Z

pag 300



2 VIE WAYS



2 VIE WAYS

2 VIE WAYS

SOLO PARTE ESTERNA - EXPOSED COMPONENTS ONLY:

EY97D2PWB

Set miscelatore a incasso a 2 vie per vasca/doccia su 3 piastre quadrate. Da completare con la seconda uscita.

2-way built-in shower mixer set on 3 square plates. To be completed with the second water outlet.

CR FIN 1



SOLO PARTE ESTERNA - EXPOSED COMPONENTS ONLY:

EY97D2WB

Set miscelatore a incasso a 2 vie per vasca/doccia su piastra rettangolare. Da completare con la seconda uscita.

2-way built-in shower mixer set on rectangular plate. To be completed with the second water outlet.

CR FIN 1



SOLO PARTE INTERNA - BUILT-IN COMPONENTS ONLY:

WBOX97D2

pag 304

SOLO PARTE INTERNA - BUILT-IN COMPONENTS ONLY:

WBOX97D2

pag 304



2 VIE
WAYS



EY92

Miscelatore monocomando a incasso per doccia, con deviatore a due posizioni (due uscite ed una entrata) su piastra unica rettangolare.

Single-lever built-in shower mixer with 2 positions diverter (2 outlets and 1 inlet) on single rectangular plate.

CR

FIN 1



3 VIE
WAYS



SOLO PARTE ESTERNA - EXPOSED COMPONENTS ONLY:

EY93ZPWB

Miscelatore a incasso per vasca/doccia con deviatore a 3 vie di tipo meccanico, su due piastre quadrate.

Built-in bath/shower mixer with 3-way mechanical diverter, on two square plates.

CR

FIN 1



SOLO PARTE INTERNA - BUILT-IN COMPONENTS ONLY:

WBOX93Z

> pag 302



SOLO PARTE ESTERNA - EXPOSED COMPONENTS ONLY:

EY93ZWB

Miscelatore a incasso per vasca/doccia con deviatore a 3 vie di tipo meccanico, su piastra rettangolare.

Built-in bath/shower mixer with 3-way mechanical diverter, on rectangular plate.

CR

FIN 1



SOLO PARTE INTERNA - BUILT-IN COMPONENTS ONLY:

WBOX93Z

> pag 302



3 VIE
WAYS



SOLO PARTE ESTERNA - EXPOSED COMPONENTS ONLY:

EY97D3PWB

Set miscelatore a incasso a 3 vie per vasca/doccia su 3 piastre quadrate. Da completare con la seconda e la terza uscita acqua.

3-way built-in bath/shower mixer set on 3 square plates. To be completed with the second and the third water outlet.

CR

FIN 1



SOLO PARTE INTERNA - BUILT-IN COMPONENTS ONLY:

WBOX97D3

> pag 308



SOLO PARTE ESTERNA - EXPOSED COMPONENTS ONLY:

EY97D3WB

Set miscelatore a incasso a 3 vie per vasca/doccia su piastra rettangolare. Da completare con la seconda e la terza uscita acqua.

3-way built-in shower mixer set on rectangular plate. To be completed with the second and the third water outlet.

CR

FIN 1



SOLO PARTE INTERNA - BUILT-IN COMPONENTS ONLY:

WBOX97D3

> pag 308

3 VIE
WAYS



EY93

Miscelatore monocomando per doccia con deviatore a tre vie (una entrata e tre uscite) su unica piastra rettangolare.
Single lever built-in shower mixer with three ways diverter (1 inlet and 3 outlets) on single rectangular plate.

CR

FIN 1



4/5 VIE
WAYS



EY94

Miscelatore monocomando per doccia, con deviatore a 4 posizioni (4 uscite ed 1 entrata) su piastra unica rettangolare.
Single-lever shower mixer with 4 positions diverter (4 outlets and 1 inlet,) on single rectangular plate.

CR

FIN 1



EY95

Miscelatore monocomando per doccia, con deviatore a 5 posizioni (5 uscite ed una entrata) su piastra unica rettangolare.
Single-lever shower mixer with 5 positions diverter (5 outlets and 1 inlet) on single rectangular plate.

CR

FIN 1



COLONNE DOCCIA - SHOWER COLUMNS



Set doccia composto da: miscelatore esterno con attacco superiore, soffione in abs 356SD20X, colonna doccia in ottone telescopica, altezza asta regolabile, con deviatore 330A, doccetta in abs con 3 funzioni 318CP, flessibile 150 cm.
 Shower set including: exposed mixer with upper connection, abs shower head 356SD20X, telescopic brass shower column, with height-adjustable rod, with diverter 330A, 3-function abs hand shower 318CP, 150 cm flexible hose.



EY37ASD20

Con soffione da 20x20 cm.
 With shower head 20x20 cm.

CR

EY37ASD25

Con soffione da 25x25 cm.
 With shower head 25x25 cm.

CR

EY37ASD30

Con soffione da 30x30 cm.
 With shower head 30x30 cm.

CR

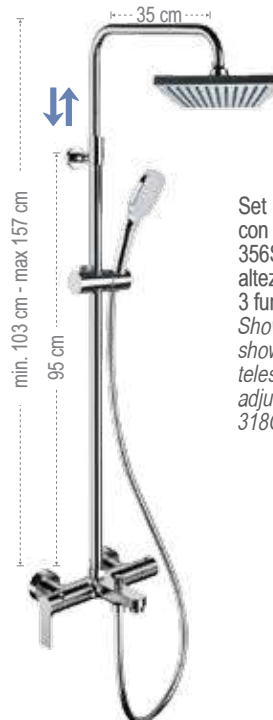

Set doccia composto da: miscelatore esterno con deviatore vasca/doccia, soffione in abs 356SD20X, colonna doccia in ottone telescopica, altezza asta regolabile 329A, doccetta in abs con 3 funzioni 318CP, flessibile 150 cm.
 Shower set including: exposed mixer with bath/shower diverter, abs shower head 356SD20X, telescopic brass shower column, with height-adjustable rod 329A, 3-function abs hand shower 318CP, 150 cm flexible hose.



EY34ASD20

Con soffione da 20x20 cm.
 With shower head 20x20 cm.

CR

EY34ASD25

Con soffione da 25x25 cm.
 With shower head 25x25 cm.

CR

EY34ASD30

Con soffione da 30x30 cm.
 With shower head 30x30 cm.

CR



EY34AEC20

Set doccia composto da: miscelatore esterno con deviatore vasca/doccia, soffione in abs Ø 20cm 354EC20X, colonna doccia in ottone telescopica, altezza asta regolabile 329A, doccetta in abs con 3 funzioni 318MP, flessibile 150 cm.
 Shower set including: exposed mixer with bath/shower diverter, abs Ø 20 cm shower head 354EC20X, telescopic brass shower column, with height-adjustable rod 329A, 3-function abs hand shower 318MP, 150 cm flexible hose.

CR



EY37AEC20

Set doccia composto da: miscelatore esterno con attacco superiore, soffione in abs Ø 20cm 354EC20X, colonna doccia in ottone telescopica, altezza asta regolabile, con deviatore 330A, doccetta in abs con 3 funzioni 318MP, flessibile 150 cm.
 Shower set including: exposed mixer with upper connection, abs Ø 20 cm shower head 354EC20X, telescopic brass shower column, with height-adjustable rod, with diverter 330A, 3-function abs hand shower 318MP, 150 cm flexible hose.

CR



ENERGY ECO



ENERGYECO



ENERGY ECO è una collezione monocomando dal design moderno e giovanile, creata per controllare e ridurre i consumi idrici ed energetici in casa. La combinazione di più tecnologie di risparmio permette infatti di limitare alla sola necessità sia il consumo di acqua che l'utilizzo di acqua calda, senza stravolgere le abitudini quotidiane. La serie è dotata di cartuccia ENERGY SAVING a dischi ceramici Ø 35 mm.

ENERGY ECO is a single-lever collection with a modern and youthful design, created to control and reduce water and energy consumption in the home. The combination of different saving technologies limit to the actual need both the consumption of water and the use of hot water, without upsetting daily habits. The series is equipped with a Ø 35 mm ceramic disc ENERGY SAVING cartridge.





PROGRAMMA ECO ECO PROGRAM



Design e tecnologia ambientale Design and environmental technology

Il programma ECO nasce per il controllo dei consumi, per un reale risparmio sia economico che ambientale. WINNER ECO combina diverse tecnologie di risparmio: cartuccia ENERGY SAVING, aeratore WATER SAVING, anello ANTISCALDING, leva WATER SAVING DYNAMIC.

Funzioni standard incluse:

La cartuccia **ENERGY SAVING** di serie evita la richiesta accidentale e involontaria di acqua calda, consentendo un risparmio energetico. Questa funzione prevede l'apertura in sola acqua fredda quando la leva è allineata alla bocca del miscelatore; per l'erogazione di acqua calda è invece necessario un movimento volontario della leva verso sinistra.

Aeratore **WATER SAVING** di serie. I miscelatori WINNER ECO sono dotati di serie di un aeratore con limitazione di portata di 6 litri al minuto (disponibile anche nelle varianti da 8, 4, 3 L / min).

Per ottimizzare il risparmio, la collezione WINNER ECO può essere integrata, su richiesta, anche con le seguenti tecnologie opzionali:

Tecnologia **ANTISCALDING** per limitare la temperatura massima dell'acqua erogabile. Questa tecnologia applica una speciale ghiera sulla cartuccia che permette, previa regolazione durante l'installazione, la limitazione della temperatura massima erogabile, impedendo la completa rotazione della maniglia verso l'acqua calda.

Tecnologia **WATER SAVING DYNAMIC**: un promemoria per utilizzare solo la quantità di acqua strettamente necessaria ad ogni operazione. Questo sistema permette di percepire una leggera limitazione all'apertura della leva intorno al 50% dell'erogazione massima d'acqua del miscelatore: un invito per l'utente a non aprire completamente il flusso dell'acqua quando non strettamente necessario. Superando questa leggera resistenza, l'erogazione del flusso al 100% della portata rimane sempre possibile e con la solita morbidezza della leva.

ECO program is created to control consumption for effective economic and environmental savings. WINNER ECO combines different saving technologies: ENERGY SAVING cartridge, WATER SAVING aerator, ANTISCALDING ring, WATER SAVING DYNAMIC lever.

Standard features included:

ENERGY SAVING cartridge as standard equipment avoids the accidental and unintentional request of hot water, thus allowing energy savings. This function provides for opening in only cold water when the lever is aligned with the mixer spout; for the supply of hot water a voluntary movement of the lever to the left is instead necessary.

WATER SAVING aerator: WINNER ECO mixers are standard equipped with a low flow aerator with a limitation of 6 liters per minute (also available in 8, 4, 3 L / min variants).

To optimize savings, WINNER ECO collection can also be easily integrated, on demand, with the following optional technologies:

ANTISCALDING ring technology to limit the maximum temperature of the water supplied. This technology applies a special ring nut on the cartridge that allows, after adjustment during installation, the limitation of the maximum deliverable temperature, preventing the complete rotation of the lever towards hot water.

WATER SAVING DYNAMIC technology: a reminder to use only the amount of water strictly necessary for each operation.

During the opening phase this system provides a slight limitation of the lever around the 50% of the maximum water supply: an invitation for the user not to fully open the water flow when not strictly necessary. By overcoming this slight resistance, the delivery of the flow at 100% of the flow is always possible and with the usual softness of the lever.

STANDARD ECO



ENERGY SAVING :

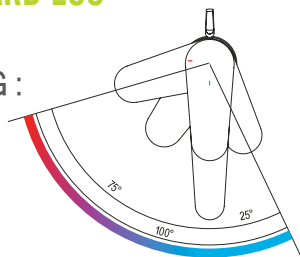

WATER SAVING :



OPTIONS:

3 L/MIN
4 L/MIN
8 L/MIN

COD. 83L6
STANDARD 6 L/min

OPTIONAL ECO



ANTISCALDING :

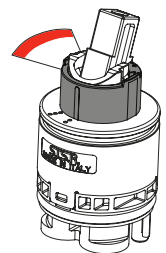

WATER SAVING DYNAMIC :

FULL FLOW 2
WATER SAVING 1
CLOSE 0

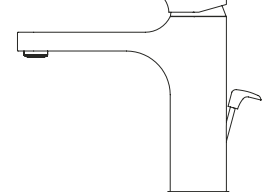



La serie Eco viene proposta in una gamma di articoli in cui la tecnologia Eco trova migliori benefici nell'uso.

Gli articoli doccia e vasca non sono stati proposti in quanto si presuppone che non vi sia la necessità di apertura in acqua fredda in quanto gli ambienti vasca e doccia sono generalmente utilizzati per loro natura con acqua miscelata/calda. Per completare la gamma Eco con gli articoli vasca/doccia si consiglia di utilizzare la serie nella versione cartuccia standard.

Le versioni eco vasca e doccia sono comunque disponibili a richiesta.

The Eco series covers a range of items in which the Eco technology finds best benefit of use.

The shower and bathtub items are not offered because it is assumed that there is no need to open in cold water as the bathtub and shower environments are generally used with mixed/hot water for their nature.

To complete the Eco range with bath/shower items, we suggest to use the series in standard cartridge version.

The bath and shower eco versions are anyway available on demand.

ENERGY ECO



FLESSIBILI MADE IN ITALY,
IN GOMMA ALIMENTARE EPDM,
RACCORDATI CON MACCHINE
AUTOMATICHE
MADE IN ITALY FLEXIBLE HOSES,
WITH EPDM ALIMENTARY RUBBER,
MADE BY AUTOMATIC
ASSEMBLING MACHINES



CARTUCCIA MADE IN ITALY
TECNOLOGICA REALIZZATA
CON PLASTICA ALIMENTARE
ECO FRIENDLY
MADE IN ITALY ECO FRIENDLY
TECHNOLOGIC CARTRIDGE

AERATORE A
RISPARMIO IDRICO
WATER SAVING
AERATOR



LAVABI ECO - ECO WASHBASIN MIXERS

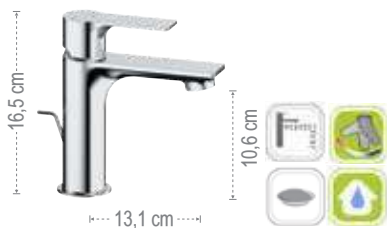

EYE10LT6

Miscelatore monocomando lavabo, con scarico.
Single-lever basin mixer, with pop-up waste.

CR



EYE11LT6

Miscelatore monocomando lavabo, senza scarico.
Single-lever basin mixer, without waste.

CR



EYE12LT6

Miscelatore monocomando lavabo, senza scarico e senza foro sul corpo.
Single-lever basin mixer, without waste and without body hole.

CR



EYE10LLT6

Miscelatore monocomando lavabo alto L, con click-clack con troppo pieno.
Single-lever L high basin mixer, with click-clack waste with overflow.

CR



EYE72CLT6

Miscelatore monocomando lavabo senza scarico, con canna corta girevole a "U", tipo lusso.
Single-lever basin mixer without waste, with short swivel "U" spout, luxury type.

CR



EYE15LT6

Miscelatore monocomando a incasso per lavabo, con piastra rettangolare in ottone.
Single-lever built-in basin mixer, with rectangular wall plate in brass.

CR

EYE11LLT6

Miscelatore monocomando lavabo alto L, senza scarico.
Single-lever L high basin mixer, without waste.

CR

BIDET ECO - ECO BIDET MIXERS



EYE20LT6

Miscelatore monocomando bidet, con scarico.
Single-lever bidet mixer, with pop-up waste.

CR



EYE22LT6

Miscelatore monocomando bidet, senza scarico.
Single-lever bidet mixer, without waste.

CR



EYE65WLT6

Miscelatore incasso per shut-off comprensivo di: doccia shut-off, supporto doccia-presa acqua su piastra in ottone e flessibile doccia cm 120.
Built-in shower mixer set including :shut-off, shower holder-water punch on flange, all in brass and shower flexible cm 120.

CR

SOFFIONI - SHOWER HEADS



351AXLT8

Soffione con disco anticalcare a snodo \varnothing 7 cm con limitatore di portata a 8 litri/minuto, con scatola.
Shower-head with anti-limestone jet \varnothing 7 cm with balljoint with 8 liters/minute flow limiter, box included.

CR



354EC20XLT8

Soffione a pioggia minimale, in abs cromato \varnothing 20 cm, con getti in silicone anticalcare con limitatore di portata a 8 litri/minuto, con scatola.
c.p. abs shower head, rain jet \varnothing 20 cm, with anti-limestone silicon jets with 8 liters/minute flow limiter, box included..

CR



357UFS25XLT8

Soffione doccia ultra piatto in acciaio inox lucidato a specchio 25x25cm, con limitatore di portata a 8 litri/minuto, con scatola.
Ultra slim stainless steel mirror polished shower head 25x25 cm, with 8 liters/minute flow limiter, box included.

CR



357UFM25XLT8

Soffione doccia ultra piatto in acciaio inox lucidato a specchio \varnothing 25 cm, con limitatore di portata a 8 litri/minuto, con scatola.
Ultra slim stainless steel mirror polished shower head \varnothing 25 cm, with 8 liters/minute flow limiter, box included.

CR

CUCINA ECO - ECO KITCHEN MIXERS



EYE72LT6

Miscelatore monocomando monoforo 90°, con canna alta girevole a "U".
Single-lever sink mixer 90°, high swivel "U" spout.

CR



EYE42RLT6

Miscelatore monocomando monoforo 90° per lavello, con bocca alta girevole ed abbattibile, tipo lusso, modello sottofinestra.
Single-lever one-hole sink mixer, with swivel and foldable high spout, luxury type, under window type.

CR



EYE41LT6

Miscelatore monocomando per lavello a muro con canna girevole 20 cm.
Single-lever wall mounted sink mixer with swivel spout length 20 cm.

CR

SLASH & DOT

GLI OPPOSTI SI ATTRAGGONO
THE OPPOSITES ATTRACT



Le collezioni SLASH & DOT sono due soluzioni complete di rubinetteria per bagno e cucina che condividono un design moderno e compatto. Il corpo tondo del miscelatore si sviluppa su una cartuccia diametro 35mm e si collega tramite una morbida curvatura ad una bocca dalle superfici piate e dai bordi smussati.

The SLASH & DOT collections are two complete faucet solutions for bathroom and kitchen that share a modern and compact design. The round body of the mixer is developed on a 35mm diameter cartridge and is connected by a soft curvature to a spout with flat surfaces and rounded edges.





SL08

SLASH&DOT



SL15PL

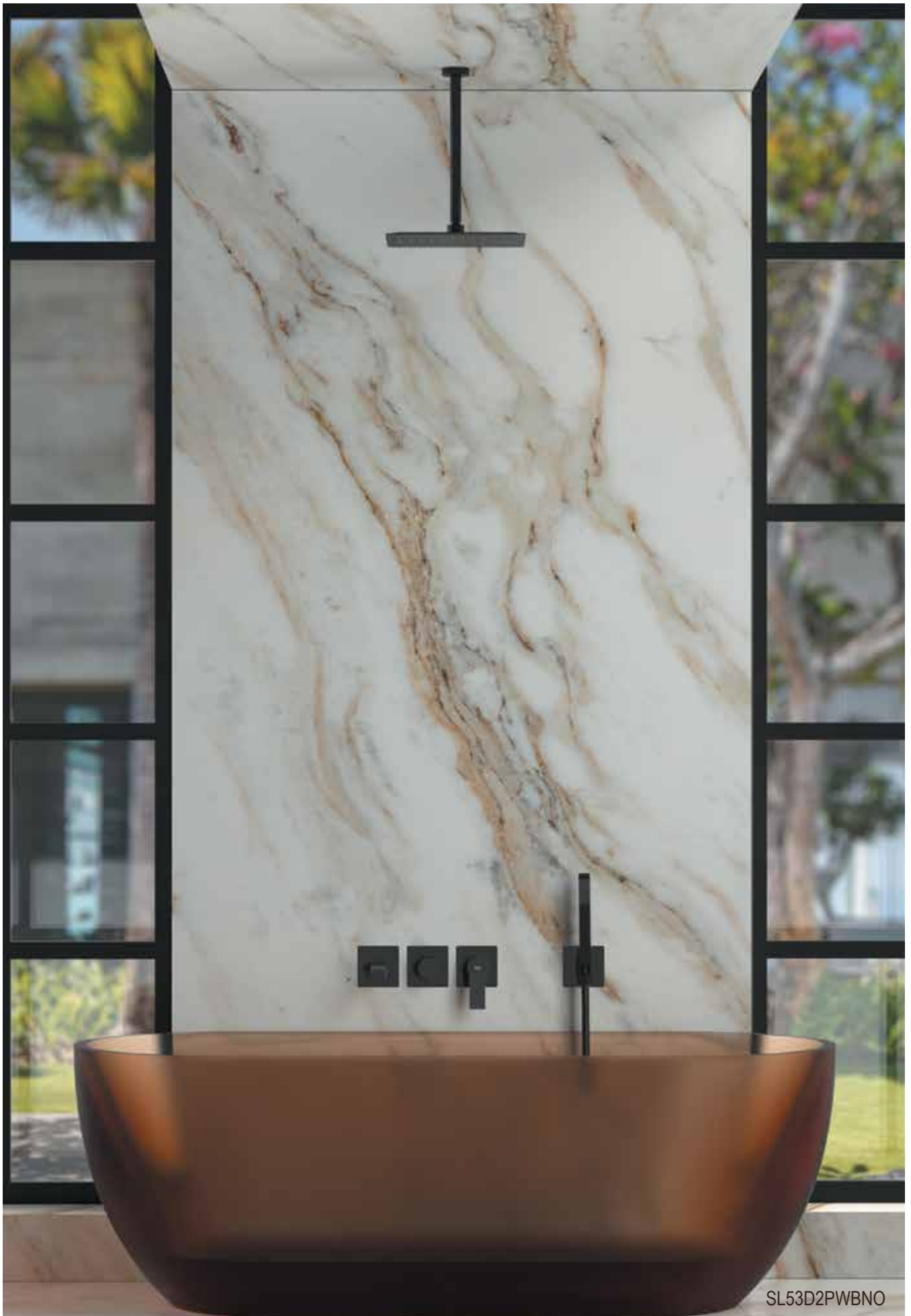

SL53D2PWBNO



SL11LXV

//////////////////// OPZIONI DI FINITURA - FINISHING OPTIONS //////////////////////

CR		FIN 1		FIN 2	
	cromo chrome		nero opaco matt black		bianco opaco matt white
	CR		visual inox visual steel		
			NO		
			BO		
			XV		

LEVA / LEVER
SLASH



SLASH & DOT

OPZIONE LEVA

La collezione è disponibile con due varianti di maniglia, identificate dalle prime due lettere del codice prodotto.

Indicare la preferenza al momento dell'ordine.

SLASH & DOT

LEVER OPTION

This collection is available with two lever options, identified by the first two letters of the product code.

Show your preference when ordering.

LEVA / LEVER
DOT



DT12NO

SLASH



Leva SLASH: SL
SLASH lever: SL
Es: SL12

DOT

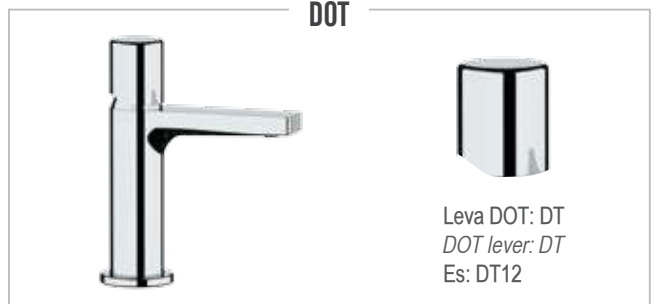

Leva DOT: DT
DOT lever: DT
Es: DT12

MISCELATORI LAVABO - WASHBASIN MIXERS



SL10
Miscelatore monocomando per lavabo, con scarico.
Single-lever basin mixer, with pop-up waste.

	CR	FIN 1
SL		
DT		



SL10L
Miscelatore monocomando alto per lavabo, scarico click-clack con troppo-pieno incluso.
High single-lever basin mixer, click-clack waste with overflow included.

	CR	FIN 1
SL		
DT		



SL57
Miscelatore monocomando per lavabo a due fori. Scarico non incluso.
2-holes single-lever basin mixer. Waste not included.

	CR	FIN 1
SL		
DT		



SL12
Miscelatore monocomando per lavabo, senza scarico e senza foro posteriore sul corpo.
Single-lever basin mixer, without waste and without rear body hole.

	CR	FIN 1
SL		
DT		



SL11L
Miscelatore monocomando alto per lavabo, senza scarico.
High single-lever basin mixer, without waste.

	CR	FIN 1
SL		
DT		



SL57L
Miscelatore monocomando per lavabo a due fori, con bocca L. Scarico non incluso.
2-holes single-lever basin mixer, with L spout. Waste not included.

	CR	FIN 1
SL		
DT		

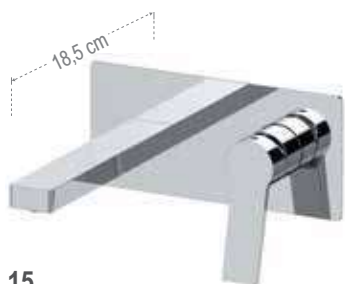

SL15
Miscelatore monocomando a incasso per lavabo. Piastra ultra-piatta. Lunghezza bocca 18,5 cm.
Single-lever built-it basin mixer. Ultra-flat plate. Spout length 18,5 cm.

	CR	FIN 1
SL		
DT		



SL15P
Miscelatore monocomando a incasso per lavabo, su due piastre quadrate separate. Lunghezza bocca 18,5 cm.
Built-in single-lever basin mixer with two separate square plates. Spout length 18,5 cm.

	CR	FIN 1
SL		
DT		

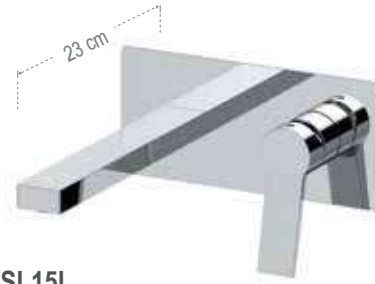

SL15L
Miscelatore monocomando a incasso per lavabo. Piastra ultra-piatta. Lunghezza bocca 23 cm.
Single-lever built-it basin mixer. Ultra-flat plate. Spout length 23 cm.

	CR	FIN 1
SL		
DT		

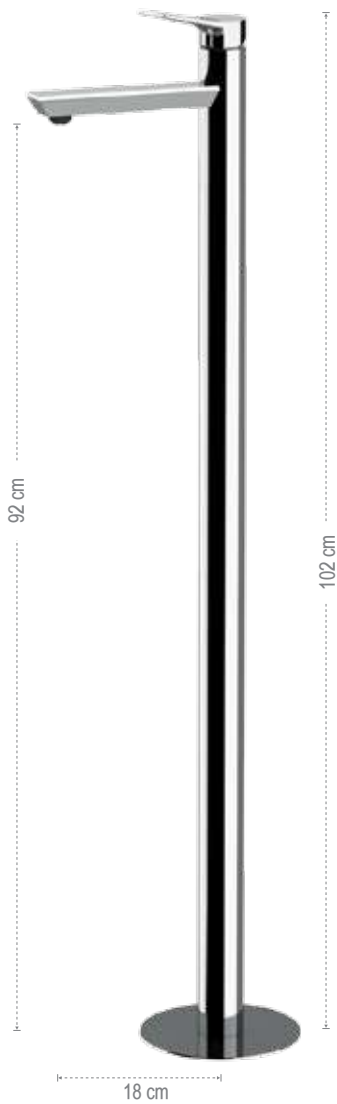

SL18

Miscelatore monocomando lavabo da terra con scarico click-clack con troppo-pieno, prodotto completo.

Single-lever mixer for floor mounting with click-clack waste and overflow. Complete product.



	CR	FIN 1
SL		
DT		

Q08FIS2

Solo parte interna.
Built-in components only.



CR

SL18E

Solo parti esterne.
Exposed components only.

	CR	FIN 1
SL		
DT		



SL15PL

Miscelatore monocomando a incasso per lavabo, su due piastre quadrate separate. Lunghezza bocca 23 cm.

Built-in single-lever basin mixer with two separate square plates. Spout length 23 cm.

	CR	FIN 1
SL		
DT		



SL72C

Miscelatore monocomando lavabo/lavello senza scarico, con canna corta girevole, tipo lusso.

Single-lever basin/sink mixer without waste, with short swivel spout, luxury type.

	CR	FIN 1
SL		
DT		



SL72

Miscelatore monocomando per lavello, con bocca alta girevole.

Single-lever one-hole sink mixer, with high swivel spout.

	CR	FIN 1
SL		
DT		

LAVABO A MURO CON BOX INCASSO - WALL WASHBASIN MIXER WITH BUILT-IN BOX



SOLO PARTE ESTERNA - EXPOSED COMPONENTS ONLY:

SL15WB

Parti esterne per miscelatore monocomando a incasso per lavabo da abbinare al box incasso (non incluso). Piastra ultra-piatta. Lunghezza bocca 18,5 cm.
Exposed components for single-lever built-in basin mixer, with ultra-flat wall plate. To match with the built-in box (not included). Spout length 18,5 cm.

	CR	FIN 1
SL		
DT		

SL15LWB

Idem sopra, con lunghezza bocca 23 cm.
Same as above, with spout length 23 cm.

	CR	FIN 1
SL		
DT		

SOLO PARTE ESTERNA - EXPOSED COMPONENTS ONLY:

SL15PWB

Parti esterne per miscelatore monocomando a incasso per lavabo da abbinare al box incasso (non incluso). Su due piastre quadrate separate. Lunghezza bocca 17 cm.

Exposed components for single-lever built-in basin mixer, with two separate square plates. To match with the built-in box (not included). Spout length 17 cm.

	CR	FIN 1
SL		
DT		

SL15PLWB

Idem sopra, con lunghezza bocca 23 cm.
Same as above, with spout length 23 cm.

	CR	FIN 1
SL		
DT		

SOLO PARTE INTERNA - BUILT-IN COMPONENTS ONLY:

WBOX15

SOLO PARTE INTERNA - BUILT-IN COMPONENTS ONLY:

WBOX15

MISCELATORI PER BIDET - BIDET MIXERS



SL20

Miscelatore monocomando per bidet, con scarico.
Single-lever bidet mixer, with pop-up waste.

	CR	FIN 1
SL		
DT		



SL22

Miscelatore monocomando per bidet, senza scarico e senza foro posteriore sul corpo.
Single-lever bidet mixer, without waste and without rear body hole.

	CR	FIN 1
SL		
DT		



SL65W

Set shut-off comprensivo di: miscelatore a incasso con supporto doccia/presa acqua, doccetta a pulsante 332OW, tutto in ottone. Flessibile doccia cm 120.

Shut-off set including: built-in mixer with shower holder/water punch on flange, shut-off hand shower 332OW, all in brass. Flexible hose cm 120.

	CR	FIN 1
SL		
DT		



SL15PLWBNO

BOCCHIE - SPOUTS

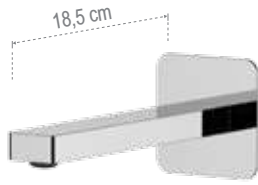

91SL

Bocca a incasso. Lunghezza bocca: 18,5 cm.
Built-in spout. Spout length: 18,5 cm

CR

FIN 1

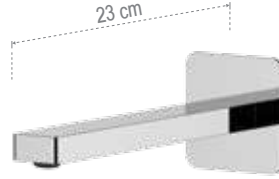

91SLL

Bocca a incasso. Lunghezza bocca: 23 cm.
Built-in spout. Spout length: 23 cm

CR

FIN 1

MISCELATORI ESTERNI PER VASCA E DOCCIA - EXPOSED MIXERS FOR BATH AND SHOWER

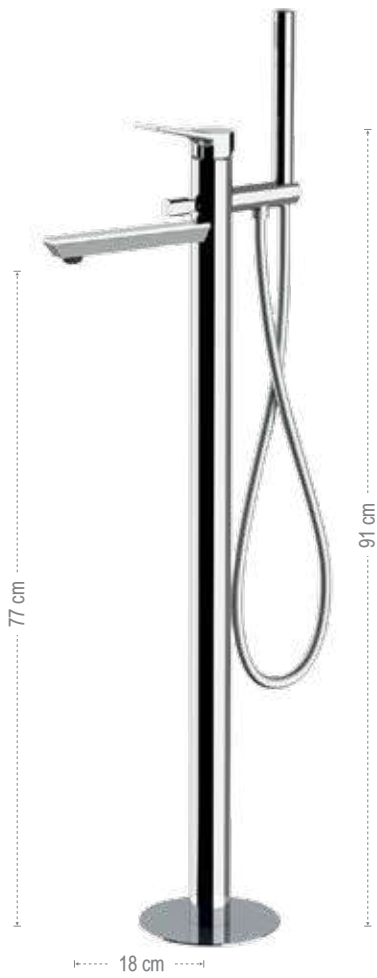

SL08

Miscelatore vasca da pavimento, con deviatore e kit doccia con doccetta in ottone 3 funzioni con pulsante cambio getti, anticalcare e flessibile 150 cm, senza scarico. Prodotto completo.
Single-lever bath mixer floor mounting, with diverter and shower kit, 3 functions antilimestone handshower with button to change jets and flexible hose 150 cm, without waste. Complete product.

CR

FIN 1

SL

DT



SL03

Miscelatore monocomando da appoggio per vasca, con deviatore, doccetta a 3 funzioni in abs con pulsante per la selezione dei getti, supporto a muro snodato. Flessibile 150cm.
Single lever bath mixer with diverter, 3-function handshower in abs with jet selection button, adjustable wall shower holder. Flexible hose 150cm.

CR

FIN 1

SL

DT

Q08FIS2

Solo parte interna.
Built-in components only.

CR

SL08E

Solo parti esterne.
Exposed components only.

CR

FIN 1

SL

DT



SL04

Miscelatore monocomando per vasca, con deviatore, senza kit doccia.
Single lever bath mixer with diverter, without shower kit.

CR

FIN 1

SL

DT



SL02

Miscelatore monocomando per vasca, doccetta a 3 funzioni in abs con pulsante per la selezione dei getti, supporto a muro snodato. Flessibile 150cm.
Single-lever bath mixer, 3-function handshower in abs with jet selection button, wall adjustable shower holder. Flexible 150cm, jointed wall bracket. Flexible hose 150cm.

	CR	FIN 1
SL		
DT		



SLC31REW

Miscelatore monocomando esterno per doccia, interasse 100 mm, con doccetta shut-off e flessibile cm 120.
Wall mounted single lever shower mixer, interaxis 100 mm, including shut-off and flexible hose cm 120.

	CR	FIN 1
SL		
DT		



SL38

Miscelatore doccia con leva frontale, doccetta a 3 funzioni in abs con pulsante per la selezione dei getti, supporto doccetta a muro. Flessibile 150cm.
Exposed shower mixer with frontal lever, 3-function handshower in abs with jet selection button, wall shower holder. Flexible hose 150cm.

	CR	FIN 1
SL		
DT		



SL05

Miscelatore monocomando per vasca con deviatore, senza kit doccia.
Wall mounted single-lever bath mixer with diverter, without shower kit.

	CR	FIN 1
SL		
DT		



SLC31

Miscelatore monocomando esterno per doccia, interasse 100 mm, senza kit doccia.
Wall mounted single lever shower mixer, interaxis 100 mm, without shower kit.

	CR	FIN 1
SL		
DT		



SL33

Miscelatore doccia con leva frontale, senza kit doccia.
Exposed shower mixer with frontal lever, without shower kit.

	CR	FIN 1
SL		
DT		

MISCELATORI A INCASSO PER VASCA - BUILT-IN MIXERS FOR BATH



SOLO PARTE ESTERNA - EXPOSED COMPONENTS ONLY:

SL53D2WB

Set a incasso a 2 vie per vasca su piastra unica rettangolare.
2-way built-in set for bathtub on a single rectangular plate.

CR

FIN 1

SL

DT



SOLO PARTE ESTERNA - EXPOSED COMPONENTS ONLY:

SL53D2PWB

Set a incasso a 2 vie per vasca su piastre quadrate separate.
2-way built-in set for bathtub on separate square plates.

CR

FIN 1

SL

DT

SOLO PARTE INTERNA - BUILT-IN COMPONENTS ONLY:

WBOX97D2

pag 304

SOLO PARTE INTERNA - BUILT-IN COMPONENTS ONLY:

WBOX97D2

pag 304



SOLO PARTE ESTERNA - EXPOSED COMPONENTS ONLY:

SL54D2WB

Set miscelatore a incasso a 2 vie per vasca/doccia su piastra unica rettangolare. Da completare con la seconda uscita.
2-way built-in mixer set for bathtub / shower on single rectangular plate. To be completed with the second water outlet.

CR

FIN 1

SL

DT

SOLO PARTE INTERNA - BUILT-IN COMPONENTS ONLY:

WBOX97D2

pag 304

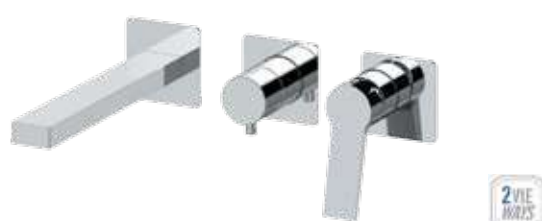

SOLO PARTE ESTERNA - EXPOSED COMPONENTS ONLY:

SL54D2PWB

Set miscelatore a incasso a 2 vie per vasca/doccia su 3 piastre quadrate. Da completare con la seconda uscita acqua.
2-way built-in mixer set for bathtub / shower on 3 square plates. To be completed with the second water outlet.

CR

FIN 1

SL

DT

SOLO PARTE INTERNA - BUILT-IN COMPONENTS ONLY:

WBOX97D2

pag 304



SOLO PARTE ESTERNA - EXPOSED COMPONENTS ONLY:

SL54D3WB

Set miscelatore a incasso a 3 vie per vasca/doccia su piastra unica rettangolare. Da completare con la seconda e la terza uscita acqua.
3-way built-in mixer set for bathtub / shower on single rectangular plate. To be completed with the second and the third water outlet.

CR

FIN 1

SL

DT

SOLO PARTE INTERNA - BUILT-IN COMPONENTS ONLY:

WBOX97D3

pag 308

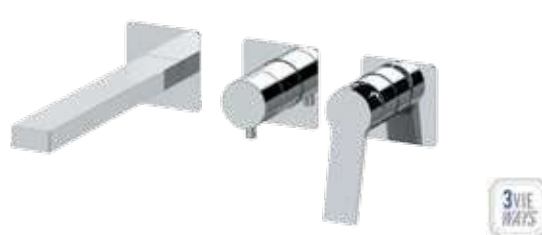

SOLO PARTE ESTERNA - EXPOSED COMPONENTS ONLY:

SL54D3PWB

Set miscelatore a incasso a 3 vie per vasca/doccia su 3 piastre quadrate. Da completare con la seconda e la terza uscita acqua.
3-way built-in mixer set for bathtub / shower on 3 separate square plates. To be completed with the second and the third water outlet.

CR

FIN 1

SL

DT

SOLO PARTE INTERNA - BUILT-IN COMPONENTS ONLY:

WBOX97D3

pag 308

Set doccia acquistabile separatamente a pagina 427 - Shower set can be purchased separately on page 427

MISCELATORI A INCASSO PER DOCCIA - BUILT-IN MIXERS FOR SHOWER

METRICA
ENERGY / ECO
SLASH / DOT
ABSOLUTE
INFINITY
VANITY
DREAM
CLASS LINE
WINNER / ECO
LIBERTY



SL30
Miscelatore incasso per doccia su piastra tonda.
Built-in shower mixer on round plate.

	CR	FIN 1
SL		
DT		



SL30L
Miscelatore incasso per doccia su piastra lusso ultrapiatta rettangolare.
Built-in shower mixer on luxury ultraslim rectangular plate.

	CR	FIN 1
SL		
DT		



SL30G
Miscelatore incasso per doccia su piastra rettangolare.
Built-in shower mixer on rectangular plate.

	CR	FIN 1
SL		
DT		



SL09
Miscelatore incasso con deviatore a pressione per vasca/doccia su piastra tonda.
Built-in bath/shower mixer with push button diverter on round plate.

	CR	FIN 1
SL		
DT		



SL09L
Miscelatore incasso con deviatore a pressione per vasca/doccia su piastra rettangolare ultra piatta.
Built-in bath/shower mixer with push button diverter on ultra-flat rectangular plate.

	CR	FIN 1
SL		
DT		

N09B
Solo parte interna.
Built-in components only.



	CR	FIN 1

SL09E
Solo parte esterna.
Exposed components only.

	CR	FIN 1

N09B
Solo parte interna.
Built-in components only.



	CR	FIN 1

SL09LE
Solo parte esterna.
Exposed components only.

	CR	FIN 1

DT09E
Solo parte esterna.
Exposed components only.

	CR	FIN 1

DT09LE
Solo parte esterna.
Exposed components only.

	CR	FIN 1

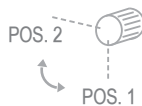

SL09G

Miscelatore incasso con deviatore a pressione per vasca/doccia su piastra rettangolare.

Built-in bath/shower mixer with push button diverter on rectangular plate.

SL09HRG

Miscelatore a incasso per vasca/doccia con deviatore a 2 vie con vitone ceramico, su piastra rettangolare, montaggio orizzontale. Per selezionare l'uscita desiderata, la manopola del deviatore deve essere ruotata da una posizione all'altra.

Built-in bath/shower mixer with 2-way diverter with ceramic head valve, on rectangular plate, horizontal mounting. To select the desired output, the diverter knob must be turned from one position to the other.

	CR	FIN 1
SL		
DT		

	CR	FIN 1
SL		
DT		

N09B

Solo parte interna.
Built-in components only.



	CR	FIN 1

SL09GE

Solo parte esterna.
Exposed components only.

	CR	FIN 1

N09HRB

Solo parte interna.
Built-in components only.



	CR	FIN 1

SL09GE

Solo parte esterna.
Exposed components only.

	CR	FIN 1

DT09GE

Solo parte esterna.
Exposed components only.

	CR	FIN 1

DT09GE

Solo parte esterna.
Exposed components only.

	CR	FIN 1

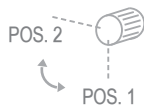

SL09HL

Miscelatore a incasso per vasca/doccia con deviatore a 2 vie a vitone ceramico. Per selezionare l'uscita desiderata, la manopola del deviatore deve essere ruotata da una posizione all'altra.

Built-in bath/shower mixer with 2-way diverter with ceramic head valve. To select the desired output, the diverter knob must be turned from one position to the other.

SL09HG

Miscelatore a incasso per vasca/doccia con deviatore a 2 vie a vitone ceramico, su piastra rettangolare. Per selezionare l'uscita desiderata, la manopola del deviatore deve essere ruotata da una posizione all'altra.

Built-in bath/shower mixer with 2-way diverter with ceramic head valve, on rectangular wall plate. To select the desired output, the diverter knob must be turned from one position to the other.

	CR	FIN 1
SL		
DT		

	CR	FIN 1
SL		
DT		

N09HB

Solo parte interna.
Built-in components only.



	CR	FIN 1

SL09LE

Solo parte esterna.
Exposed components only.

	CR	FIN 1

N09HB

Solo parte interna.
Built-in components only.



	CR	FIN 1

SL09GE

Solo parte esterna.
Exposed components only.

	CR	FIN 1

DT09LE

Solo parte esterna.
Exposed components only.

	CR	FIN 1

DT09GE

Solo parte esterna.
Exposed components only.

	CR	FIN 1

2 VIE
WAYS

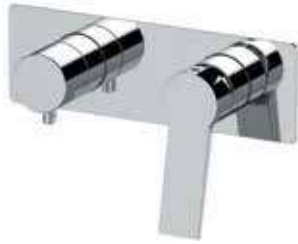

SOLO PARTE ESTERNA - EXPOSED COMPONENTS ONLY:

SL92ZWB

Miscelatore a incasso per vasca/doccia con deviatore a 2 vie di tipo meccanico, su piastra rettangolare.
Built-in bath/shower mixer with 2-way mechanical diverter, on rectangular plate.

SL	CR	FIN 1
DT		

SOLO PARTE INTERNA - BUILT-IN COMPONENTS ONLY:

WBOX92Z

pag 300



SOLO PARTE ESTERNA - EXPOSED COMPONENTS ONLY:

SL92ZPWB

Miscelatore a incasso per vasca/doccia con deviatore a 2 vie di tipo meccanico, su due piastre quadrate.
Built-in bath/shower mixer with 2-way mechanical diverter, on two square plates.

SL	CR	FIN 1
DT		

SOLO PARTE INTERNA - BUILT-IN COMPONENTS ONLY:

WBOX92Z

pag 300

2 VIE
WAYS



SOLO PARTE ESTERNA - EXPOSED COMPONENTS ONLY:

SL97D2PWB

Set miscelatore a incasso a 2 vie per vasca/doccia su 3 piastre quadrate. Da completare con la seconda uscita.
2-way built-in shower mixer set on 3 square plates. To be completed with the second water outlet.

SL	CR	FIN 1
DT		

SOLO PARTE INTERNA - BUILT-IN COMPONENTS ONLY:

WBOX97D2

pag 304



SOLO PARTE ESTERNA - EXPOSED COMPONENTS ONLY:

SL97D2WB

Set miscelatore a incasso a 2 vie per vasca/doccia su piastra rettangolare. Da completare con la seconda uscita.
2-way built-in shower mixer set on rectangular plate. To be completed with the second water outlet.

SL	CR	FIN 1
DT		

SOLO PARTE INTERNA - BUILT-IN COMPONENTS ONLY:

WBOX97D2

pag 304



SL92

Miscelatore monocomando a incasso per doccia, con deviatore a due posizioni (due uscite ed una entrata) su piastra unica rettangolare.
Single-lever built-in shower mixer with 2 positions diverter (2 outlets and 1 inlet) on single rectangular plate.

SL	CR	FIN 1
DT		



3 VIE
WAYS



SOLO PARTE ESTERNA - EXPOSED COMPONENTS ONLY:

SL93ZWB

Miscelatore a incasso per vasca/doccia con deviatore a 3 vie di tipo meccanico, su piastra rettangolare.

Built-in bath/shower mixer with 3-way mechanical diverter, on rectangular plate.

SL	CR	FIN 1
DT		

SOLO PARTE ESTERNA - EXPOSED COMPONENTS ONLY:

SL93ZPWB

Miscelatore a incasso per vasca/doccia con deviatore a 3 vie di tipo meccanico, su due piastre quadrate.

Built-in bath/shower mixer with 3-way mechanical diverter, on two square plates.

SL	CR	FIN 1
DT		

SOLO PARTE INTERNA - BUILT-IN COMPONENTS ONLY:

WBOX93Z

pag 302

SOLO PARTE INTERNA - BUILT-IN COMPONENTS ONLY:

WBOX93Z

pag 302



3 VIE
WAYS



SOLO PARTE ESTERNA - EXPOSED COMPONENTS ONLY:

SL97D3PWB

Set miscelatore a incasso a 3 vie per vasca/doccia su 3 piastre quadrate. Da completare con la seconda e la terza uscita acqua.

3-way built-in bath/shower mixer set on 3 square plates. To be completed with the second and the third water outlet.

SL	CR	FIN 1
DT		

SOLO PARTE ESTERNA - EXPOSED COMPONENTS ONLY:

SL97D3WB

Set miscelatore a incasso a 3 vie per vasca/doccia su piastra rettangolare. Da completare con la seconda e la terza uscita acqua.

3-way built-in shower mixer set on rectangular plate. To be completed with the second and the third water outlet.

SL	CR	FIN 1
DT		

SOLO PARTE INTERNA - BUILT-IN COMPONENTS ONLY:

WBOX97D3

pag 308

SOLO PARTE INTERNA - BUILT-IN COMPONENTS ONLY:

WBOX97D3

pag 308



3 VIE
WAYS



SL93

Miscelatore monocomando per doccia con deviatore a tre vie (una entrata e tre uscite) su unica piastra rettangolare.

Single lever built-in shower mixer with three ways diverter (1 inlet and 3 outlets) on single rectangular plate.

SL	CR	FIN 1
DT		

4/5 VIE WAYS



SL94

Miscelatore monocomando per doccia, con deviatore a 4 posizioni (4 uscite ed 1 entrata) su piastra unica rettangolare.
 Single-lever shower mixer with 4 positions diverter (4 outlets and 1 inlet,) on single rectangular plate.

SL	CR	FIN 1
DT		



SL95

Miscelatore monocomando per doccia, con deviatore a 5 posizioni (5 uscite ed una entrata) su piastra unica rettangolare.
 Single-lever shower mixer with 5 positions diverter (5 outlets and 1 inlet) on single rectangular plate.

SL	CR	FIN 1
DT		



SL53D2WB

ABSOLUTE

ESSENZA DI PRECISIONE
ESSENCE OF PRECISION



ABSOLUTE è una collezione di rubinetteria monocomando dalle linee prevalentemente squadrate. Il miscelatore, fuso in un unico blocco, elimina qualsiasi intersezione creando un'elegante continuità nel design. Disponibile in diverse colorazioni di finitura, la rubinetteria ABSOLUTE si inserisce con gusto ed originalità in ogni progetto di arredo bagno moderno. La serie è dotata di cartuccia a dischi ceramici Ø 35 mm.

ABSOLUTE is a single-lever faucet collection with a predominance of squared lines. The mixer, cast in a single block, eliminates any intersection, creating an elegant continuity of design. Available in different finishing colours, ABSOLUTE faucets fit with taste and originality in any modern bathroom furnishing project. The series is equipped with a Ø 35 mm ceramic disc cartridge



ABSOLUTE



AU10L



AU08

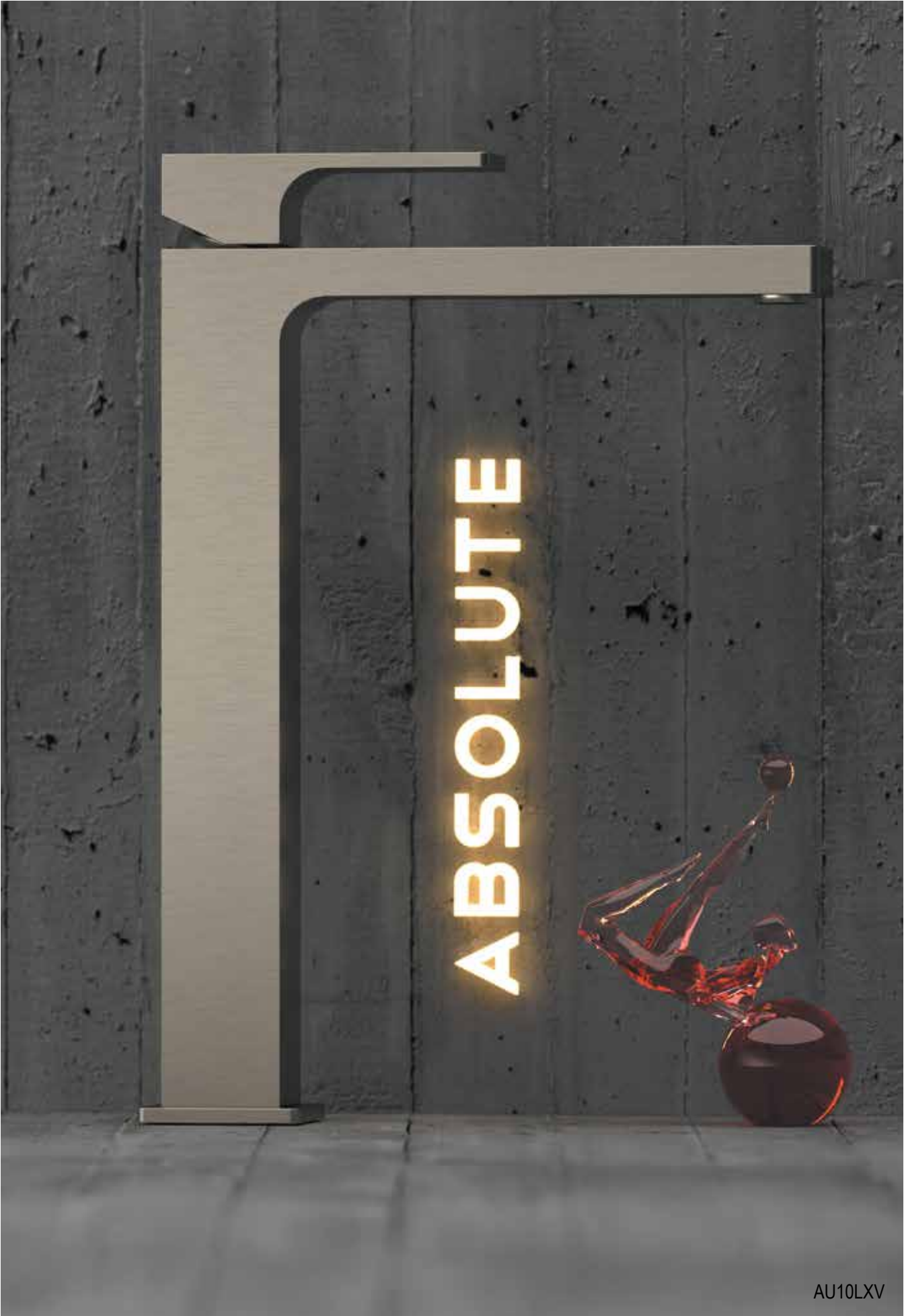

AU10LXV



AU12ANO - AU11BO

OPZIONI DI FINITURA - FINISHING OPTIONS

CR		FIN 1		FIN 2	
	cromo chrome		nero opaco matt black		cromo nero spazzolato brushed black chrome
	CR		bianco opaco matt white		oro spazzolato brushed gold
			visual inox visual steel		oro lucido shiny gold
			NO		CFP
			BO		BG
			XV		DO

MISCELATORI LAVABO - WASHBASIN MIXERS

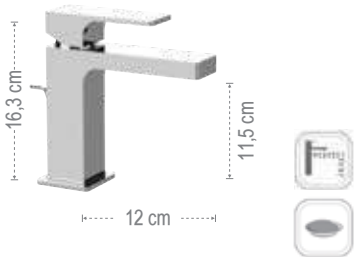

AU10
Monocomando lavabo, con scarico.
Single-lever basin mixer, with pop-up waste.

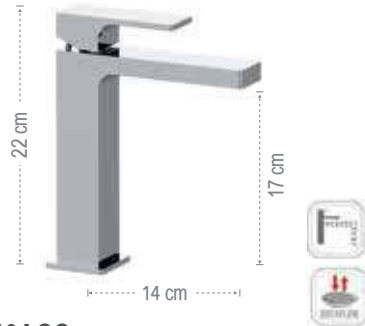
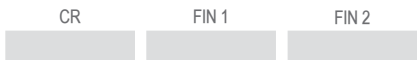

AU10ACC
Miscelatore monocomando per lavabo, modello "A" altezza media, scarico click-clack con troppo-pieno incluso.
Single-lever basin mixer, model "A" medium height, click-clack waste with overflow included.

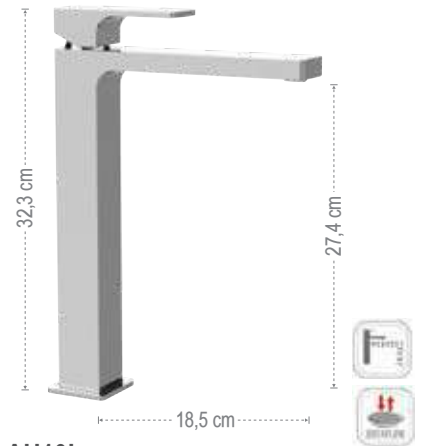

AU10L
Monocomando lavabo alto senza foro sul corpo, con scarico click-clack con troppo-pieno.
High basin mixer without body hole, with click-clack waste and overflow.



AU11
Monocomando lavabo, senza scarico.
Single-lever basin mixer, without waste.

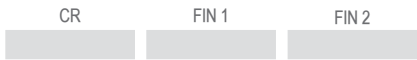

AU12A
Miscelatore monocomando per lavabo, modello "A" altezza media, senza scarico e senza foro sul corpo.
Single-lever basin mixer, model "A" medium height, without pop-up waste and with no rear hole.

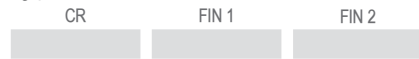

AU11L
Monocomando lavabo alto senza foro sul corpo, senza scarico.
High basin mixer without body hole, without waste.

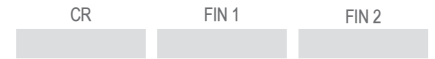

AU12
Monocomando lavabo, senza scarico e senza foro sul corpo.
Single-lever basin mixer, without waste and without body hole.

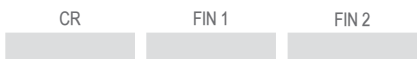

AU57
Miscelatore monocomando lavabo due fori.
Two holes single-lever washbasin mixer.



AU10G
Miscelatore monocomando lavabo, con canna corta a "U" e scarico click-clack quadrato con troppo pieno.
Single-lever one-hole sink mixer, with short "U" spout, with squared click-clack waste with overflow.

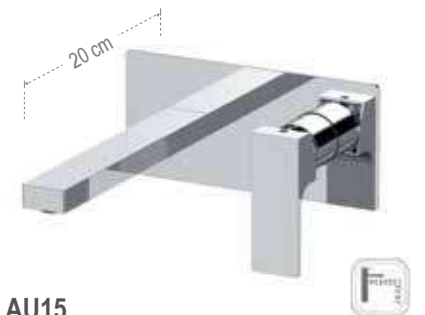

AU15
Miscelatore monocomando a incasso per lavabo, in ottone, lunghezza bocca 20 cm.
Single-lever built-in basin mixer, in brass, spout length 20 cm.



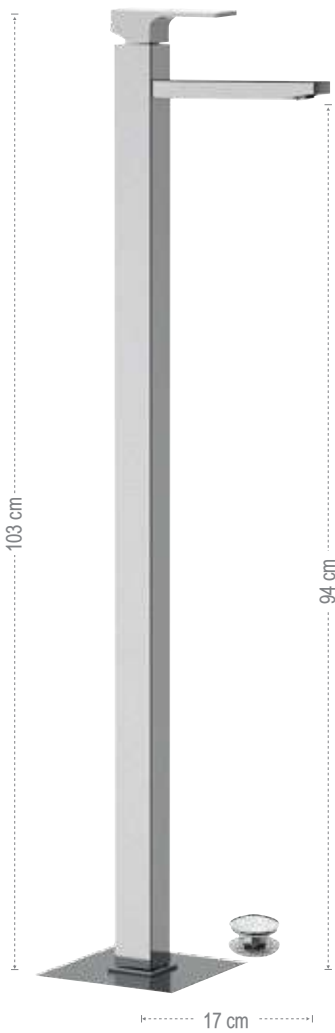

AU18

Miscelatore monocomando lavabo da terra con scarico click-clack con troppo-pieno. Prodotto completo.
Single-lever mixer for floor mounting with click-clack waste with overflow. Complete product.

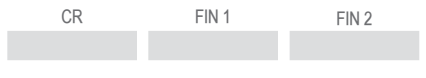

Q08FIS2

Solo parte interna.
Built-in components only.

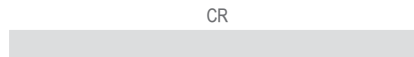

AU18E

Solo parti esterne.
Exposed components only.



BOCCHIE - SPOUTS

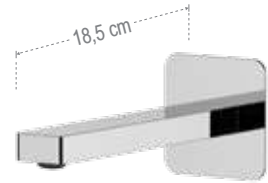

91SL

Bocca a incasso. Lunghezza bocca: 18,5 cm.
Built-in spout. Spout length: 18,5 cm

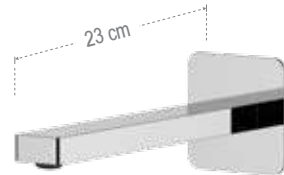
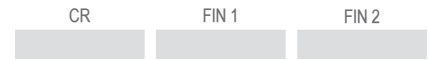

91SLL

Bocca a incasso. Lunghezza bocca: 23 cm.
Built-in spout. Spout length: 23 cm

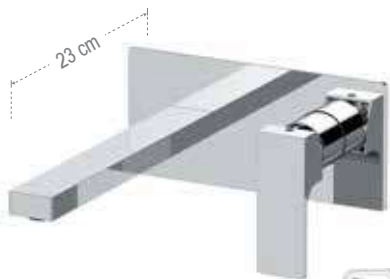
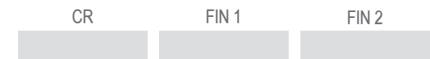

AU15L

Miscelatore monocomando a incasso per lavabo, in ottone, lunghezza bocca 23 cm.
Single-lever built-in basin mixer, in brass, spout length 23 cm.

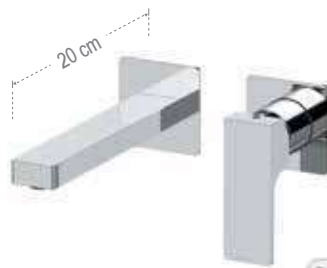

AU15P

Miscelatore monocomando a incasso per lavabo, su due piastre quadre separate, lunghezza bocca 20 cm.
Built-in single-lever basin mixer on two separate square plates, spout length 20 cm.



AU15PL

Miscelatore monocomando a incasso per lavabo, su due piastre quadre separate. Lunghezza bocca 23 cm.
Built-in single-lever basin mixer on two separate square plates. Spout length 23 cm.



LAVABO A MURO CON BOX INCASSO - WALL WASHBASIN MIXER WITH BUILT-IN BOX

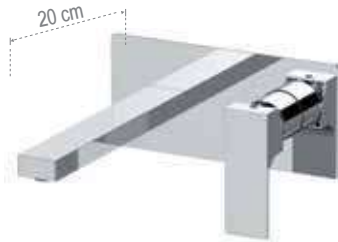

SOLO PARTE ESTERNA - EXPOSED COMPONENTS ONLY:

AU15WB

Parti esterne per miscelatore monocomando a incasso per lavabo da abbinare al box incasso (non incluso). Piastra ultra-piatta. Lunghezza bocca 20 cm.
Exposed components for single-lever built-in basin mixer, with ultra-flat wall plate. To match with the built-in box (not included). Spout length 20 cm.



AU15LWB

Idem sopra, con lunghezza bocca 23 cm.
Same as above, with spout length 23 cm.



SOLO PARTE ESTERNA - EXPOSED COMPONENTS ONLY:

AU15PWB

Parti esterne per miscelatore monocomando a incasso per lavabo da abbinare al box incasso (non incluso). Su due piastre quadrate separate. Lunghezza bocca 20 cm.

Exposed components for single-lever built-in basin mixer, with two separate square plates. To match with the built-in box (not included). Spout length 20 cm.



AU15PLWB

Idem sopra, con lunghezza bocca 23 cm.
Same as above, with spout length 23 cm.

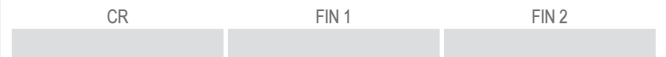

SOLO PARTE INTERNA - BUILT-IN COMPONENTS ONLY:

WBOX15

SOLO PARTE INTERNA - BUILT-IN COMPONENTS ONLY:

WBOX15

MISCELATORI BIDET - BIDET MIXERS

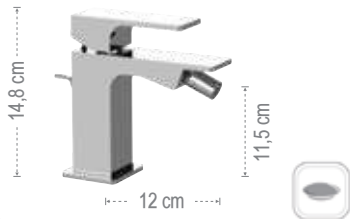

AU20

Monocomando bidet, con scarico.
Single-lever bidet mixer, with pop-up waste.

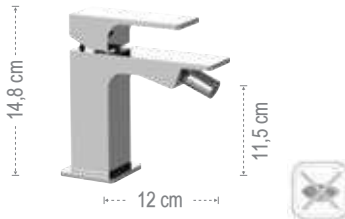

AU21

Monocomando bidet, senza scarico.
Single-lever bidet mixer, without waste.

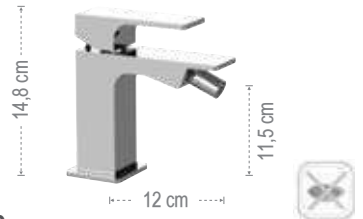

AU22

Monocomando bidet, senza scarico e senza foro sul corpo.
Single-lever bidet mixer, without waste and without body hole

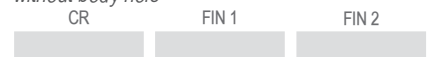

Q64

Miscelatore shut-off quadrato con cartuccia progressiva, apertura su acqua fredda e passaggio ad acqua calda tramite rotazione di maniglia unica, comprensivo di doccetta shut-off 332OS e flessibile cm 120.
Shut-off square mixer with progressive cartridge, opening with cold water, switching on hot water by rotating one single handle including shut-off 332OS and flexible hose 120 cm.



AU65

Miscelatore incasso per shut-off comprensivo di doccetta shut-off, supporto doccia/presa acqua, attacco conico da 1/2", tutto in ottone, flessibile doccia cm 120.
Built-in shut-off mixer, set including: shut-off, shower holder/water punch on flange all in brass, with 1/2 connection, handshower support and flexible cm 120.



AU65B

Miscelatore incasso per shut-off, senza set doccia.
Built-in shut-off mixer, without shower kit.



MISCELATORI ESTERNI PER VASCA E DOCCIA - EXPOSED MIXERS FOR BATH AND SHOWER

METRICA
ENERGY / ECO
SLASH / DOT
ABSOLUTE
INFINITY
VANITY
DREAM
CLASS LINE
WINNER / ECO
LIBERTY

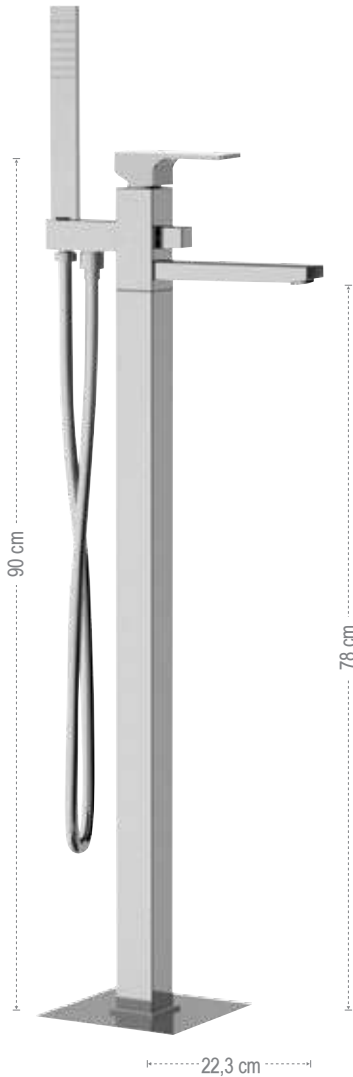

AU08

Miscelatore bordo vasca da pavimento, con deviatore e kit doccia in ottone. Prodotto completo.
Single-lever bath mixer floor mounting, with diverter and brass shower kit. Complete product.

CR FIN 1 FIN 2



Q08FIS2

Solo parte interna.
Built-in components only.



CR



AU08E

Solo parti esterne.
Exposed components only.

CR FIN 1 FIN 2



AU02

Miscelatore monocomando per vasca, con kit doccia e doccetta anticalcare ad 1 funzione.
Wall mounted single-lever bath mixer, with shower set and anti-limescale 1 function handshower.

CR FIN 1 FIN 2

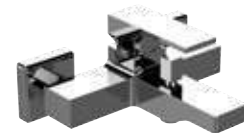

AU05

Miscelatore monocomando per vasca, senza set doccia.
Wall mounted single-lever bath mixer, without shower kit.

CR FIN 1 FIN 2



AU39

Miscelatore monocomando doccia esterno con kit doccia.
Wall mounted single-lever shower mixer with shower kit.

CR FIN 1 FIN 2



AU31

Miscelatore monocomando doccia esterno senza kit doccia.
Wall mounted single-lever shower mixer without shower kit.

CR FIN 1 FIN 2



MISCELATORI A INCASSO PER VASCA - BUILT-IN MIXERS FOR BATH

2 VIE
WAYS

SOLO PARTE ESTERNA - EXPOSED COMPONENTS ONLY:

AU53D2WB

Set a incasso a 2 vie per vasca su piastra unica rettangolare.
2-way built-in set for bathtub on a single rectangular plate.

CR FIN 1 FIN 2

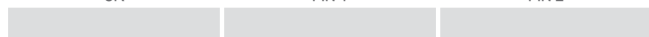

SOLO PARTE INTERNA - BUILT-IN COMPONENTS ONLY:

WBOX97D2

pag 304



SOLO PARTE ESTERNA - EXPOSED COMPONENTS ONLY:

AU53D2PWB

Set a incasso a 2 vie per vasca su piastre quadrate separate.
2-way built-in set for bathtub on separate square plates.

CR FIN 1 FIN 2

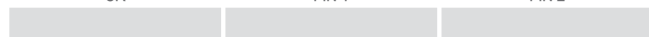

SOLO PARTE INTERNA - BUILT-IN COMPONENTS ONLY:

WBOX97D2

pag 304

2 VIE
WAYS

SOLO PARTE ESTERNA - EXPOSED COMPONENTS ONLY:

AU54D2WB

Set miscelatore a incasso a 2 vie per vasca/doccia su piastra unica rettangolare. Da completare con la seconda uscita.
2-way built-in mixer set for bathtub / shower on single rectangular plate. To be completed with the second water outlet.

CR FIN 1 FIN 2



SOLO PARTE INTERNA - BUILT-IN COMPONENTS ONLY:

WBOX97D2

pag 304



SOLO PARTE ESTERNA - EXPOSED COMPONENTS ONLY:

AU54D2PWB

Set miscelatore a incasso a 2 vie per vasca/doccia su piastre quadrate separate. Da completare con la seconda uscita.
2-way built-in mixer set for bathtub / shower on separate square plates. To be completed with the second water outlet.

CR FIN 1 FIN 2



SOLO PARTE INTERNA - BUILT-IN COMPONENTS ONLY:

WBOX97D2

pag 304

3 VIE
WAYS

SOLO PARTE ESTERNA - EXPOSED COMPONENTS ONLY:

AU54D3WB

Set miscelatore a incasso a 3 vie per vasca/doccia su piastra unica rettangolare. Da completare con la seconda e la terza uscita acqua.
3-way built-in mixer set for bathtub / shower on single rectangular plate. To be completed with the second and the third water outlet.

CR FIN 1 FIN 2



SOLO PARTE INTERNA - BUILT-IN COMPONENTS ONLY:

WBOX97D3

pag 308



SOLO PARTE ESTERNA - EXPOSED COMPONENTS ONLY:

AU54D3PWB

Set miscelatore a incasso a 3 vie per vasca/doccia su piastre quadrate separate. Da completare con la seconda e la terza uscita acqua.
3-way built-in mixer set for bathtub / shower on separate square plates. To be completed with the second and the third water outlet.

CR FIN 1 FIN 2



SOLO PARTE INTERNA - BUILT-IN COMPONENTS ONLY:

WBOX97D3

pag 308

Set doccia acquistabile separatamente a pagina 427 - Shower set can be purchased separately on page 427

MISCELATORI A INCASSO PER DOCCIA - *BUILT-IN MIXERS FOR SHOWER*

1 VIA WAY



AU30

Miscelatore monocomando a incasso per doccia completo, su piastra rettangolare.
Complete single lever built-in shower mixer, on rectangular plate.



2 VIE WAYS



AU09

Miscelatore monocomando incasso con deviatore per vasca/doccia completo, su piastra rettangolare.
Complete single lever built-in bath/shower mixer with diverter, on rectangular plate.



2 VIE WAYS

N09B

Solo parte interna.
Built-in components only.



AU09E

Solo parte esterna.
Exposed components only.



2 VIE WAYS

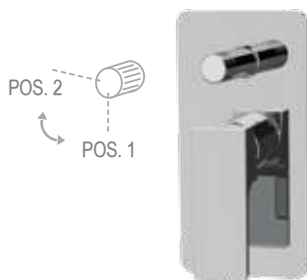

AU09HL

Miscelatore a incasso per vasca/doccia con deviatore a 2 vie a vitone ceramico. Per selezionare l'uscita desiderata, la manopola del deviatore deve essere ruotata da una posizione all'altra.
Built-in bath/shower mixer with 2-way diverter with ceramic head valve. To select the desired output, the diverter knob must be turned from one position to the other.



2 VIE WAYS

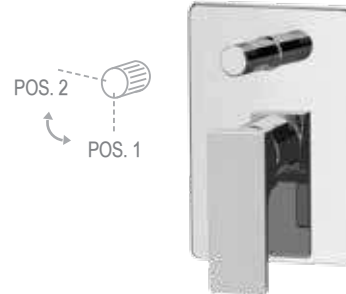

AU09HG

Miscelatore a incasso per vasca/doccia con deviatore a 2 vie a vitone ceramico, su piastra rettangolare. Per selezionare l'uscita desiderata, la manopola del deviatore deve essere ruotata da una posizione all'altra.
Built-in bath/shower mixer with 2-way diverter with ceramic head valve, on rectangular wall plate. To select the desired output, the diverter knob must be turned from one position to the other.



2 VIE WAYS

N09HB

Solo parte interna.
Built-in components only.



AU09E

Solo parte esterna.
Exposed components only.



N09HB

Solo parte interna.
Built-in components only.



AU09GE

Solo parte esterna.
Exposed components only.



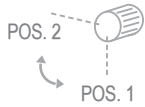

AU09HRG

Miscelatore a incasso per vasca/doccia con deviatore a 2 vie con vitone ceramico, su piastra rettangolare, montaggio orizzontale. Per selezionare l'uscita desiderata, la manopola del deviatore deve essere ruotata da una posizione all'altra.
Built-in bath/shower mixer with 2-way diverter with ceramic head valve, on rectangular plate, horizontal mounting. To select the desired output, the diverter knob must be turned from one position to the other.



AU92

Miscelatore monocomando a incasso per doccia, con deviatore a due posizioni (due uscite ed una entrata) su piastra unica rettangolare.
Single-lever built-in shower mixer with 2 positions diverter (2 outlets and 1 inlet) on single on rectangular plate.

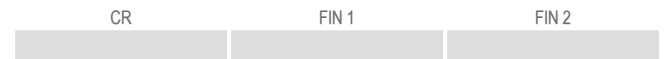

N09HRB

Solo parte interna.
Built-in components only.

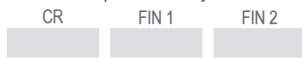

AU09GE

Solo parte esterna.
Exposed components only.

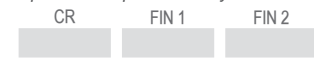

SOLO PARTE ESTERNA - EXPOSED COMPONENTS ONLY:

AU92ZPWB

Miscelatore a incasso per vasca/doccia con deviatore a 2 vie di tipo meccanico, su due piastre quadrate.
Built-in bath/shower mixer with 2-way mechanical diverter, on two square plates.



SOLO PARTE INTERNA - BUILT-IN COMPONENTS ONLY:

WBOX92Z

pag 300



SOLO PARTE ESTERNA - EXPOSED COMPONENTS ONLY:

AU92ZWB

Miscelatore a incasso per vasca/doccia con deviatore a 2 vie di tipo meccanico, su piastra rettangolare.
Built-in bath/shower mixer with 2-way mechanical diverter, on rectangular plate.



SOLO PARTE INTERNA - BUILT-IN COMPONENTS ONLY:

WBOX92Z

pag 300



SOLO PARTE ESTERNA - EXPOSED COMPONENTS ONLY:

AU97D2WB

Set miscelatore a incasso a 2 vie per vasca/doccia su piastra rettangolare. Da completare con la seconda uscita.
2-way built-in shower mixer set on rectangular plate. To be completed with the second water outlet.

CR FIN 1 FIN 2

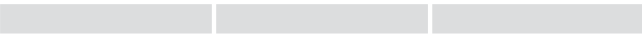

SOLO PARTE INTERNA - BUILT-IN COMPONENTS ONLY:

WBOX97D2

pag 304



SOLO PARTE ESTERNA - EXPOSED COMPONENTS ONLY:

AU97D2PWB

Set miscelatore a incasso a 2 vie per vasca/doccia su 3 piastre quadrate. Da completare con la seconda uscita.
2-way built-in shower mixer set on 3 square plates. To be completed with the second water outlet.

CR FIN 1 FIN 2

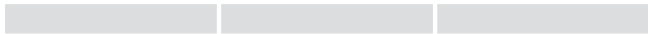

SOLO PARTE INTERNA - BUILT-IN COMPONENTS ONLY:

WBOX97D2

pag 304



SOLO PARTE ESTERNA - EXPOSED COMPONENTS ONLY:

AU93ZPWB

Miscelatore a incasso per vasca/doccia con deviatore a 3 vie di tipo meccanico, su due piastre quadrate.
Built-in bath/shower mixer with 3-way mechanical diverter, on two square plates.

CR FIN 1 FIN 2

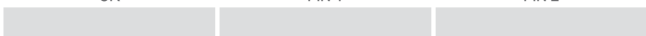

SOLO PARTE INTERNA - BUILT-IN COMPONENTS ONLY:

WBOX93Z

pag 302



SOLO PARTE ESTERNA - EXPOSED COMPONENTS ONLY:

AU93ZWB

Miscelatore a incasso per vasca/doccia con deviatore a 3 vie di tipo meccanico, su piastra rettangolare.
Built-in bath/shower mixer with 3-way mechanical diverter, on rectangular plate.

CR FIN 1 FIN 2

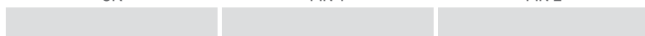

SOLO PARTE INTERNA - BUILT-IN COMPONENTS ONLY:

WBOX93Z

pag 302

3 VIE
WAYS

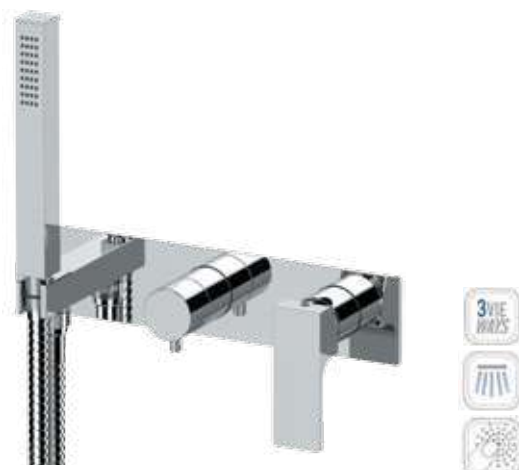

SOLO PARTE ESTERNA - EXPOSED COMPONENTS ONLY:

AU97D3WB

Set miscelatore a incasso a 3 vie per vasca/doccia su piastra rettangolare. Da completare con la seconda e la terza uscita acqua.
3-way built-in shower mixer set on rectangular plate. To be completed with the second and the third water outlet.

CR FIN 1 FIN 2

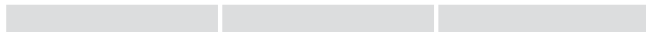

SOLO PARTE ESTERNA - EXPOSED COMPONENTS ONLY:

AU97D3PWB

Set miscelatore a incasso a 3 vie per vasca/doccia su 3 piastre quadrate. Da completare con la seconda e la terza uscita acqua.
3-way built-in bath/shower mixer set on 3 square plates. To be completed with the second and the third water outlet.

CR FIN 1 FIN 2

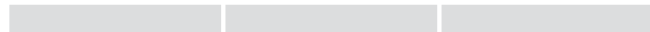

SOLO PARTE INTERNA - BUILT-IN COMPONENTS ONLY:

WBOX97D3

pag 308

SOLO PARTE INTERNA - BUILT-IN COMPONENTS ONLY:

WBOX97D3

pag 308

4/5 VIE
WAYS



AU93

Miscelatore monocomando per doccia con deviatore a tre vie (una entrata e tre uscite) su unica piastra rettangolare.
Single lever built-in shower mixer with three ways diverter (1 inlet and 3 outlets) on single rectangular plate.

CR FIN 1 FIN 2

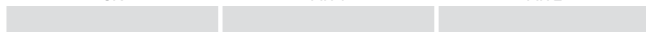

AU94

Miscelatore monocomando per doccia, con deviatore a 4 posizioni (4 uscite ed 1 entrata) su piastra unica rettangolare.
Single-lever shower mixer with 4 positions diverter (4 outlets and 1 inlet,) on single rectangular plate.

CR FIN 1 FIN 2



AU95

Miscelatore monocomando per doccia, con deviatore a 5 posizioni (5 uscite ed una entrata) su piastra unica rettangolare.
Single-lever shower mixer with 5 positions diverter (5 outlets and 1 inlet,) on single rectangular plate.

CR FIN 1 FIN 2

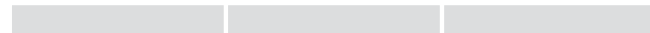

COLONNE DOCCIA - SHOWER COLUMNS

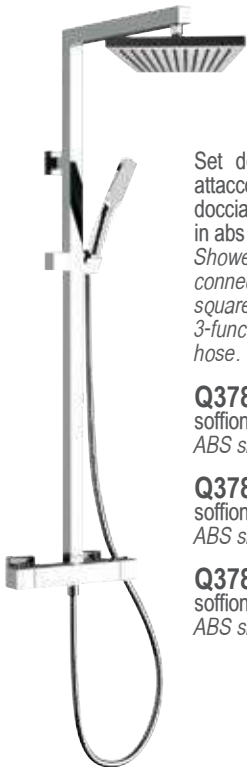

Set doccia composto da: miscelatore esterno con attacco superiore, soffione in ABS 356SD20X, colonna doccia quadrata in ottone con deviatore 330S, doccetta in abs con 3 funzioni 318CP, flessibile 150 cm.
Shower set including: exposed mixer with upper connection, ABS antilimestone showerhead 356SD20X, square brass shower column with diverter 330S, 3-function abs hand shower 318CP, 150 cm flexible hose.

- Q378CPSD20**
soffione in ABS 20x20 cm.
ABS showerhead 20x20 cm. CR
- Q378CPSD25**
soffione in ABS 25x25 cm.
ABS showerhead 25x25 cm. CR
- Q378CPSD30**
soffione in ABS 30x30 cm.
ABS showerhead 30x30 cm. CR

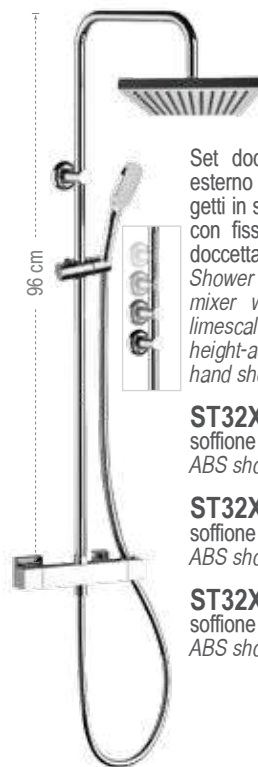

Set doccia composto da: miscelatore termostatico esterno quadrato con deviatore, soffione in ABS con getti in silicone anticalcare 356SD20X, colonna doccia con fissaggio superiore regolabile in altezza 329X, doccetta in abs con 3 funzioni 318CP, flessibile 150 cm.
Shower set including: square exposed thermostatic mixer with diverter, abs shower head with anti-limescale silicone jets 356SD20X, shower column with height-adjustable upper fixing 329X, 3-function abs hand shower 318CP, 150 cm flexible hose.

- ST32X8CPSD20**
soffione in ABS 20x20 cm.
ABS showerhead 20x20 cm. CR
- ST32X8CPSD25**
soffione in ABS 25x25 cm.
ABS showerhead 25x25 cm. CR
- ST32X8CPSD30**
soffione in ABS 30x30 cm.
ABS showerhead 30x30 cm. CR

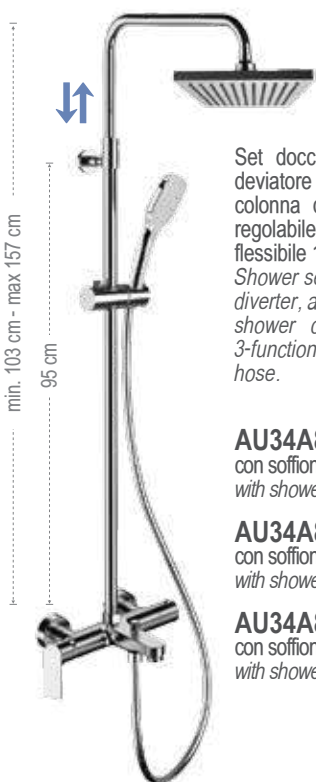

Set doccia composto da: miscelatore esterno con deviatore vasca/doccia, soffione in abs 356SD20X, colonna doccia in ottone telescopica, altezza asta regolabile 329A, doccetta in abs con 3 funzioni 318CP, flessibile 150 cm.
Shower set including: exposed mixer with bath/shower diverter, abs shower head 356SD20X, telescopic brass shower column, with height-adjustable rod 329A, 3-function abs hand shower 318CP, 150 cm flexible hose.

- AU34A8CPSD20**
con soffione da 25x25 cm.
with shower head 25x25 cm. CR
- AU34A8CPSD25**
con soffione da 25x25 cm.
with shower head 25x25 cm. CR
- AU34A8CPSD30**
con soffione da 25x25 cm.
with shower head 25x25 cm. CR



MISCELATORI LAVABO CASCATA - WATERFALL WASHBASIN MIXERS



QC10
 Miscelatore monocomando lavabo bocca a cascata, con scarico quadrato.
Single-lever basin mixer with waterfall spout, with squared pop-up waste.

CR



QC11
 Miscelatore monocomando lavabo bocca a cascata, senza scarico.
Single-lever basin mixer with waterfall spout, without waste.

CR



QC10L
 Miscelatore monocomando lavabo alto L con bocca a cascata, con scarico quadrato click-clack con troppo-pieno.
Single-lever basin mixer L high neck with waterfall spout, with squared click-clack waste with overflow.

CR



QC10LB
 Miscelatore monocomando lavabo alto L con bocca a cascata, con scarico quadrato click-clack senza troppo-pieno.
Single-lever basin mixer L high neck with waterfall spout, with squared click-clack waste without overflow.

CR



QC11L
 Miscelatore monocomando lavabo alto L con bocca a cascata, senza scarico, senza foro sul corpo.
Single-lever basin mixer L high neck with waterfall spout, without waste and body hole.

CR



QC15
 Miscelatore monocomando a incasso per lavabo, con piastra verticale rettangolare in ottone e bocca a cascata squadrata.
Single lever built-it basin mixer, with rectangular wall plate in chrome plated brass.

CR

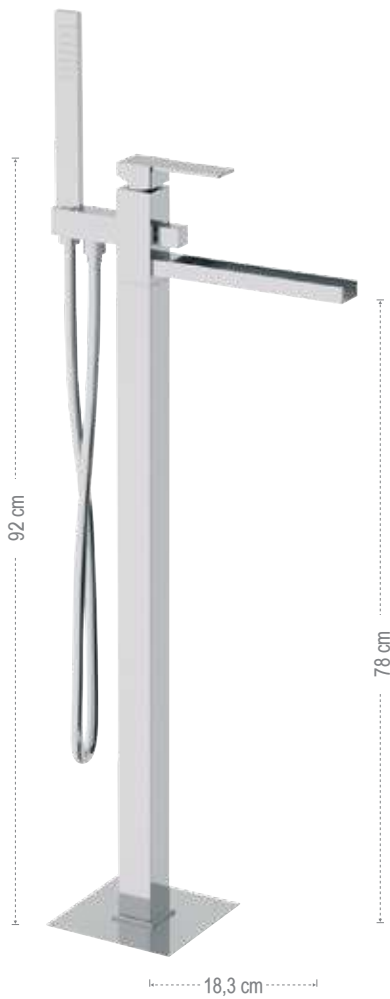

QC08

Miscelatore vasca da pavimento, con doccetta ad 1 funzione in ottone, bocca a cascata, deviatore e flessibile 150 cm. Prodotto completo.
Single-lever bath mixer floor mounting, with 1 function handshower in brass, with waterfall spout and diverter, flexible hose 150 cm. Complete product.



CR

Q08FIS2

Solo parte interna.
Built-in components only.



CR

QC08E

Solo parti esterne.
Exposed components only.

CR

BOCCE - SPOUTS

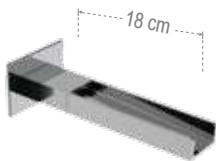

91QC

Bocca incasso a cascata.
Built-in spout with waterfall jet.

CR



91ZC

Bocca incasso a cascata.
Built-in spout with waterfall jet.

CR



91ZCA

Bocca bordo vasca getto cascata.
Spout for deck bath/shower with waterfall jet.

CR



91ZCF

Bocca bordo vasca multigetto.
Spout for deck bath/shower with multijet.

CR



INFINITY

ARMONIA PER UNO STILE RAFFINATO
HARMONY FOR EXQUISITE STYLE



Infinity nasce da un'idea di design in cui la resa estetica di leggerezza del prodotto ricopre un ruolo di primaria importanza. La morbidezza del corpo ed i suoi raggi addolciti sono interrotti in corrispondenza della bocca di erogazione e della leva, entrambe caratterizzate dallo stesso profilo, estremamente assottigliate e con una superficie superiore completamente piana. La serie è dotata di cartuccia a dischi ceramici Ø 35 mm.

Infinity was born from an idea of design in which a role of primary importance is given to the final impact of lightness that the whole line gives. The smoothness of the body and its wide rays are interrupted in correspondance of the spout and the lever which suddenly show a completely flat upper surface. The series is equipped with a Ø 35 mm ceramic disc cartridge.



INFINITY





INFINITY

I10L



I11LNP



I15PLXV

OPZIONI DI FINITURA - FINISHING OPTIONS

CR		FIN 1		FIN 2	
	cromo chrome		nero opaco matt black		oro spazzolato brushed gold
	CR		bianco opaco matt white		oro lucido shiny gold
			visual inox visual steel		
			NO		BG
			BO		DO
			XV		

MISCELATORI LAVABO - WASHBASIN MIXERS



I10
Miscelatore monocomando lavabo, con scarico.
Single-lever basin mixer, with pop-up waste.

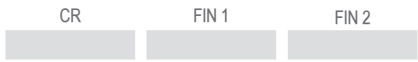

I10L
Miscelatore monocomando lavabo, con scarico click-clack con troppo-pieno.
Single-lever basin mixer, with click-clack waste and overflow.

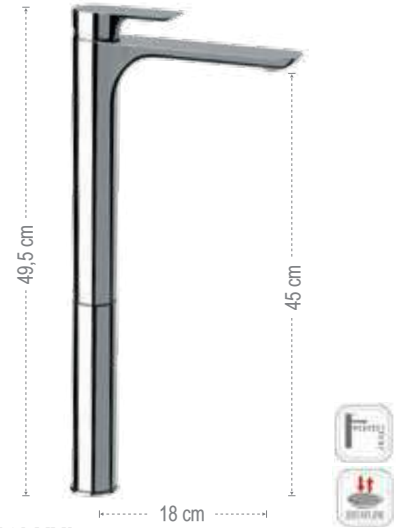
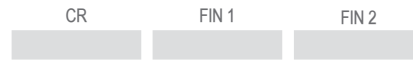

I10LXXL
Miscelatore monocomando lavabo alto XXL, con scarico click-clack con troppo-pieno.
XXL high single-lever basin mixer, with click-clack waste and overflow.

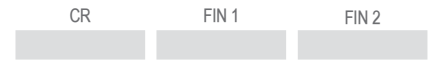

I11
Miscelatore monocomando lavabo, senza scarico.
Single-lever basin, mixer without waste.

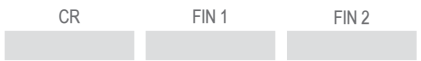

I11L
Miscelatore monocomando lavabo, senza scarico.
Single-lever basin mixer, without waste.

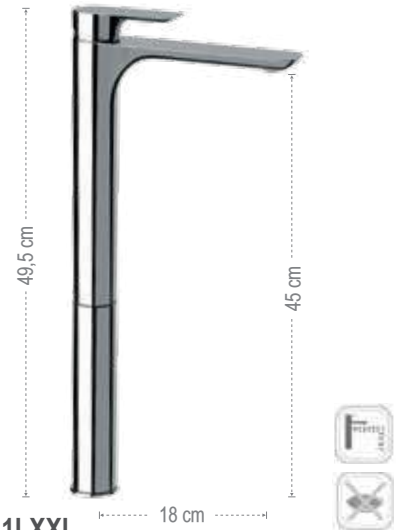

I11LXXL
Miscelatore monocomando lavabo alto XXL, senza scarico.
XXL high single-lever basin mixer, without waste.

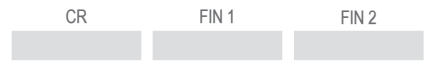

I12
Miscelatore monocomando lavabo, senza scarico e senza foro sul corpo.
Single-lever basin mixer, without waste and without body hole.





I15
Miscelatore monocomando a incasso per lavabo, con piastra in ottone.
Single-lever built-in basin mixer, with wall plate in brass.

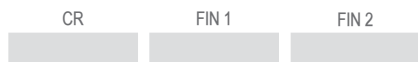

I15L
Miscelatore monocomando a incasso per lavabo, con piastra in ottone. Lunghezza bocca 23 cm.
Single-lever built-in basin mixer, with wall plate in brass. Length spout 23 cm.



I15P
Miscelatore monocomando a incasso per lavabo, su due piastre quadre separate.
Built-in single-lever basin mixer on two separate square plates.

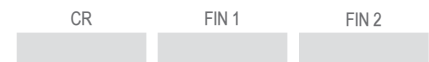

I15PL
Miscelatore monocomando a incasso per lavabo, su due piastre quadre separate. Lunghezza bocca 23 cm.
Built-in single-lever basin mixer on two separate square plates. Length spout 23 cm.



I72C
Miscelatore monocomando lavabo, con canna corta girevole, tipo lusso.
Single-lever basin mixer without waste, with short swivel spout, luxury type.

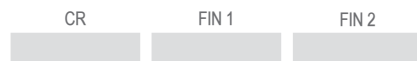

I72
Miscelatore monocomando monoforo 90°, con canna alta a "U" girevole.
Single-lever sink mixer 90°, high "U" swivel spout.

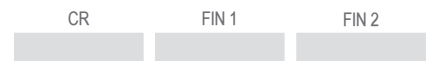

I57
Miscelatore monocomando lavabo due fori senza scarico.
Two holes single-lever washbasin mixer without waste.



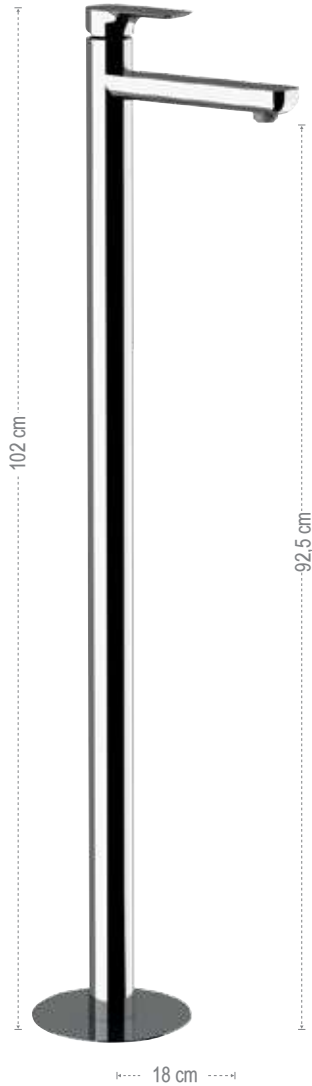

BOCCHIE - SPOUTS

I18
 Miscelatore monocomando lavabo da terra con scarico click-clack con troppo-pieno. Prodotto completo.
Single-lever mixer for floor mounting with click-clack waste with overflow. Complete product.

CR FIN 1 FIN 2

911
 Bocca incasso.
Built-in spout.

18 cm

CR FIN 1 FIN 2

Q08FIS2
 Solo parte interna.
Built-in components only.

CR

911L
 Lunghezza bocca 23cm.
Spout length 23cm.

23 cm

CR FIN 1 FIN 2

I18E
 Solo parti esterne.
Exposed components only.

CR FIN 1 FIN 2

LAVABO A MURO CON BOX INCASSO - WALL WASHBASIN MIXER WITH BUILT-IN BOX



SOLO PARTE ESTERNA - EXPOSED COMPONENTS ONLY:

I15WB
 Parti esterne per miscelatore monocomando a incasso per lavabo da abbinare al box incasso (non incluso). Piastra ultra-piatta. Lunghezza bocca 18 cm.
Exposed components for single-lever built-in basin mixer, with ultra-flat wall plate. To match with the built-in box (not included). Spout length 18 cm.

CR FIN 1 FIN 2

I15PWB
 Parti esterne per miscelatore monocomando a incasso per lavabo da abbinare al box incasso (non incluso). Su due piastre quadrate separate. Lunghezza bocca 18 cm.
Exposed components for single-lever built-in basin mixer, with two separate square plates. To match with the built-in box (not included). Spout length 18 cm.

CR FIN 1 FIN 2

I15LWB
 Idem sopra, con lunghezza bocca 23 cm.
Same as above, with spout length 23 cm.

CR FIN 1 FIN 2

I15PLWB
 Idem sopra, con lunghezza bocca 23 cm.
Same as above, with spout length 23 cm.

CR FIN 1 FIN 2

SOLO PARTE INTERNA - BUILT-IN COMPONENTS ONLY:

WBOX15

SOLO PARTE INTERNA - BUILT-IN COMPONENTS ONLY:

WBOX15

MISCELATORI BIDET - *BIDET MIXERS*



I20
Monocomando bidet, con scarico.
Single-lever bidet mixer, with pop-up waste.



I21
Monocomando bidet, senza scarico.
Single-lever bidet mixer, without pop-up waste.

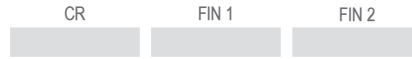

I22
Miscelatore monocomando bidet senza scarico e senza foro sul corpo.
Single-lever bidet mixer without waste and without body hole.

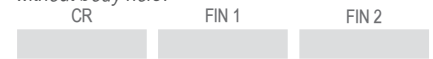

I60W
Miscelatore incasso shut-off coprensivo di: doccetta shut-off, supporto doccia-presa acqua, tutto in ottone e flessibile cm 120.
Built-in shower mixer set including: shut-off, shower holder water punch, all in brass and flexible hose cm 120

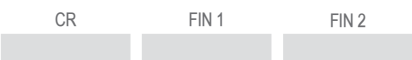

IC31REW
Miscelatore monocomando esterno doccia, interasse 10 cm per shut-off, con doccetta a pulsante, flessibile 120 cm e supporto in ottone.
Shut-off wall mounted single lever shower mixer, interaxis 10 cm, with shut-off handshower, flexible hose cm 120 and brass shower older.



I65W
Miscelatore incasso per shut-off con supporto doccia/presa acqua integrato, attacco conico da 1/2", tutto in ottone, con doccetta shut-off e flessibile cm 120.
Built-in shower mixer with integrated shower holder/water punch on flange all in brass, with 1/2 connection, including shut-off and flexible hose cm 120.



IC31
Miscelatore monocomando esterno doccia, interasse 10 cm per shut-off, senza kit doccia.
Shut-off wall mounted single lever shower mixer, interaxis 10 cm, without shower kit.



I65B
Miscelatore incasso per shut-off con supporto doccia/presa acqua integrato, attacco conico da 1/2", tutto in ottone, senza kit doccia.
Built-in shower mixer with integrated shower holder/water punch on flange all in brass, with 1/2 connection, without shower kit.



MISCELATORI ESTERNI PER VASCA E DOCCIA - EXPOSED MIXERS FOR BATH AND SHOWER



I02
 Miscelatore vasca, con flessibile cm 150 e doccia ovale ad 1 funzione con getti anticalcare.
Wall mounted bath mixer, with flexible hose cm 150 and 1 function antilimestone oval handshower.

CR



I49
 Miscelatore lavabo/vasca con canna fusa lunga 30 cm e deviatore, con flessibile cm 150 e doccia ovale ad 1 funzione con getti anticalcare.
Wall basin/bath single lever mixer with cm 30 long casted spout with diverter, with flexible hose cm 150 and 1 function antilimestone oval handshower.

CR



IR38
 Miscelatore doccia con leva frontale, con flessibile cm 150 e doccia ovale ad 1 funzione con getti in anticalcare.
Wall mounted shower mixer with frontal lever, with flexible hose cm 150 and 1 function antilimestone oval handshower.

CR



I05
 Miscelatore vasca, senza kit doccia.
Wall mounted bath mixer, without shower kit.

CR

FIN 1

FIN 2



I46
 Miscelatore lavabo/vasca con canna fusa lunga 30 cm e deviatore, senza kit doccia.
Wall basin/bath single lever mixer without shower kit.

CR

FIN 1

FIN 2



IR33
 Miscelatore doccia con leva frontale, senza kit doccia.
Wall mounted shower mixer with frontal lever, without shower kit.

CR

FIN 1

FIN 2



I39
 Miscelatore doccia, con flessibile cm 150 e doccia ovale ad 1 funzione con getti anticalcare.
Wall mounted, with flexible hose cm 150 and 1 function antilimestone oval handshower.

CR



I31
 Miscelatore doccia, senza kit doccia.
Wall mounted, without shower kit.

CR

FIN 1

FIN 2

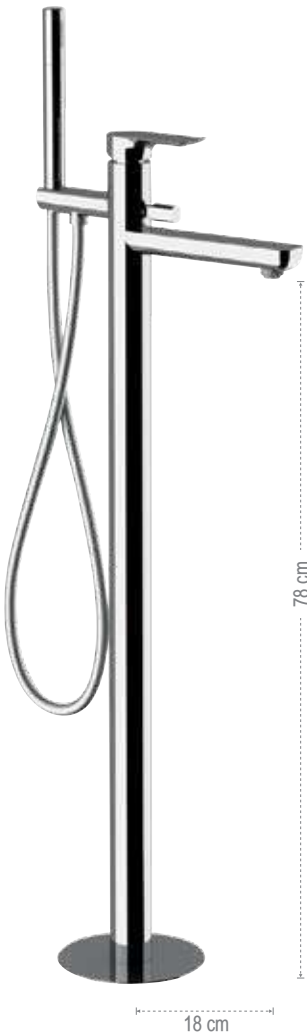

I08

Miscelatore bordo vasca da pavimento, con deviatore e doccia ad 1 funzione e flessibile 150 cm in ottone. Prodotto completo.
Single-lever bath mixer floor mounting, with diverter and brass 1 function handshower and flexible hose 150 cm. Complete product.



CR FIN 1 FIN 2

Q08FIS2

Solo parte interna.
Built-in components only.



CR

I08E

Solo parti esterne.
Exposed components only.

CR FIN 1 FIN 2



I07

Miscelatore monocomando bordo vasca con deviatore a leva integrato nella bocca minimale e doccia estraibile ad 1 funzione anticalcare.
Single lever deck bath mixer with with lever diverter integrated on the spout, with minimal spout and pull-out 1 function antilimestone handshower.

CR



I07UF

Miscelatore monocomando bordo vasca con deviatore integrato nel miscelatore, bocca a cascata e doccia ad 1 funzione anticalcare.
Single lever deck bath mixer with diverter integrated on the mixer, with waterfall spout and pull-out 1 function antilimestone handshower.

CR



I27

Miscelatore bordo vasca con deviatore integrato nel miscelatore e doccia anticalcare ad 1 funzione estraibile.
Single lever bath deck mixer with diverter integrated on the mixer and pull-out 1 function antilimestone handshower.

CR

MISCELATORI A INCASSO PER VASCA - BUILT-IN MIXERS FOR BATH



2 VIE
WAYS



SOLO PARTE ESTERNA - EXPOSED COMPONENTS ONLY:

I53D2WB

Set a incasso a 2 vie per vasca su piastra unica rettangolare.
2-way built-in set for bathtub on a single rectangular plate

CR FIN 1 FIN 2



SOLO PARTE INTERNA - BUILT-IN COMPONENTS ONLY:

WBOX97D2

pag 304



SOLO PARTE ESTERNA - EXPOSED COMPONENTS ONLY:

I53D2PWB

Set a incasso a 2 vie per vasca su piastre quadrate separate.
2-way built-in set for bathtub on separate square plates

CR FIN 1 FIN 2



SOLO PARTE INTERNA - BUILT-IN COMPONENTS ONLY:

WBOX97D2

pag 304

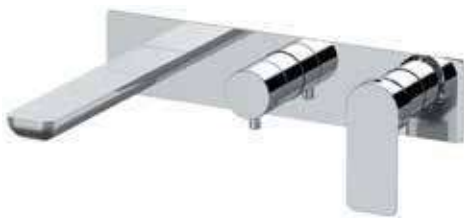

2 VIE
WAYS



SOLO PARTE ESTERNA - EXPOSED COMPONENTS ONLY:

I54D2WB

Set miscelatore a incasso a 2 vie per vasca/doccia su piastra unica rettangolare. Da completare con la seconda uscita.
2-way built-in mixer set for bathtub / shower on single rectangular plate. To be completed with the second water outlet.

CR FIN 1 FIN 2

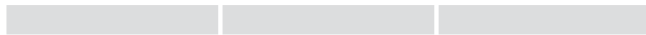

SOLO PARTE INTERNA - BUILT-IN COMPONENTS ONLY:

WBOX97D2

pag 304



SOLO PARTE ESTERNA - EXPOSED COMPONENTS ONLY:

I54D2PWB

Set miscelatore a incasso a 2 vie per vasca/doccia su 3 piastre quadrate. Da completare con la seconda uscita acqua.
2-way built-in mixer set for bathtub / shower on 3 square plates. To be completed with the second water outlet.

CR FIN 1 FIN 2

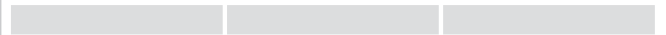

SOLO PARTE INTERNA - BUILT-IN COMPONENTS ONLY:

WBOX97D2

pag 304

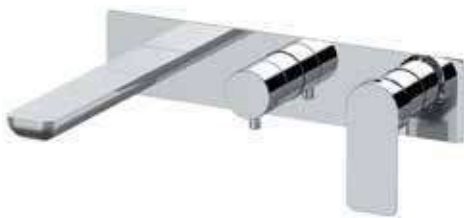

3 VIE
WAYS



SOLO PARTE ESTERNA - EXPOSED COMPONENTS ONLY:

I54D3WB

Set miscelatore a incasso a 3 vie per vasca/doccia su piastra unica rettangolare. Da completare con la seconda e la terza uscita acqua.
3-way built-in mixer set for bathtub / shower on single rectangular plate. To be completed with the second and the third water outlet.

CR FIN 1 FIN 2

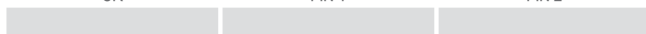

SOLO PARTE INTERNA - BUILT-IN COMPONENTS ONLY:

WBOX97D3

pag 308



SOLO PARTE ESTERNA - EXPOSED COMPONENTS ONLY:

I54D3PWB

Set miscelatore a incasso a 3 vie per vasca/doccia su 3 piastre quadrate. Da completare con la seconda e la terza uscita acqua.
3-way built-in mixer set for bathtub / shower on 3 separate square plates. To be completed with the second and the third water outlet.

CR FIN 1 FIN 2

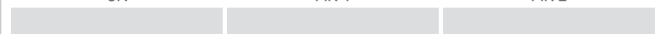

SOLO PARTE INTERNA - BUILT-IN COMPONENTS ONLY:

WBOX97D3

pag 308

Set doccia acquistabile separatamente a pagina 427 - Shower set can be purchased separately on page 427

MISCELATORI A INCASSO PER DOCCIA - BUILT-IN MIXERS FOR SHOWER

1 VIA WAY



I30
Miscelatore monocomando a incasso per doccia completo.
Complete single lever built-in shower mixer.

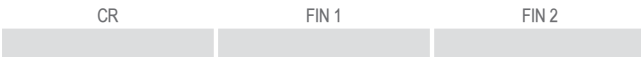

2 VIE WAYS



2 VIE WAYS

I09
Miscelatore monocomando a incasso con deviatore per vasca/doccia completo.
Complete single lever built-in bath/shower mixer with diverter.



N09B
Solo parte interna.
Built-in components only.



I09E
Solo parte esterna.
Exposed components only.



2 VIE WAYS



2 VIE WAYS

I09HL
Miscelatore a incasso per vasca/doccia con deviatore a 2 vie a vitone ceramico. Per selezionare l'uscita desiderata, la manopola del deviatore deve essere ruotata da una posizione all'altra.
Built-in bath/shower mixer with 2-way diverter with ceramic head valve. To select the desired output, the diverter knob must be turned from one position to the other.



2 VIE WAYS

I09HRG
Miscelatore a incasso per vasca/doccia con deviatore a 2 vie con vitone ceramico, su piastra rettangolare, montaggio orizzontale. Per selezionare l'uscita desiderata, la manopola del deviatore deve essere ruotata da una posizione all'altra.
Built-in bath/shower mixer with 2-way diverter with ceramic head valve, on rectangular plate, horizontal mounting. To select the desired output, the diverter knob must be turned from one position to the other.



N09HB
Solo parte interna.
Built-in components only.



I09E
Solo parte esterna.
Exposed components only.



N09HRB
Solo parte interna.
Built-in components only.



I09GE
Solo parte esterna.
Exposed components only.



METRICA
ENERGY / ECO
SLASH / DOT
ABSOLUTE
INFINITY
VANITY
DREAM
CLASS LINE
WINNER / ECO
LIBERTY



SOLO PARTE ESTERNA - EXPOSED COMPONENTS ONLY:

I92ZWB

Miscelatore a incasso per vasca/doccia con deviatore a 2 vie di tipo meccanico, su piastra rettangolare.
Built-in bath/shower mixer with 2-way mechanical diverter, on rectangular plate.



SOLO PARTE ESTERNA - EXPOSED COMPONENTS ONLY:

I92ZPWB

Miscelatore a incasso per vasca/doccia con deviatore a 2 vie di tipo meccanico, su due piastre quadrate.
Built-in bath/shower mixer with 2-way mechanical diverter, on two square plates.

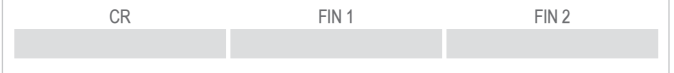

SOLO PARTE INTERNA - BUILT-IN COMPONENTS ONLY:

WBOX92Z

> pag 300

SOLO PARTE INTERNA - BUILT-IN COMPONENTS ONLY:

WBOX92Z

> pag 300



SOLO PARTE ESTERNA - EXPOSED COMPONENTS ONLY:

I97D2PWB

Set miscelatore a incasso a 2 vie per vasca/doccia su 3 piastre quadrate. Da completare con la seconda e la terza uscita acqua.
2-way built-in bath/shower mixer set on 3 square plates. To be completed with the second and the third water outlet.

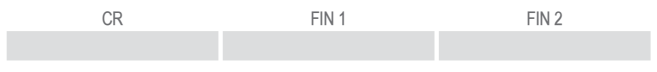

SOLO PARTE INTERNA - BUILT-IN COMPONENTS ONLY:

WBOX97D2

> pag 304



SOLO PARTE ESTERNA - EXPOSED COMPONENTS ONLY:

I97D2WB

Set miscelatore a incasso a 2 vie per vasca/doccia su piastra rettangolare. Da completare con la seconda e la terza uscita acqua.
2-way built-in shower mixer set on rectangular plate. To be completed with the second and the third water outlet.



SOLO PARTE INTERNA - BUILT-IN COMPONENTS ONLY:

WBOX97D2

> pag 304

2 VIE
WAYS



2 VIE
WAYS

I92

Miscelatore monocomando a incasso per doccia, con deviatore a due posizioni (due uscite ed una entrata) su piastra unica.
Single-lever built-in shower mixer with 2 positions diverter (2 outlets and 1 inlet) on single plate.

CR FIN 1 FIN 2

3 VIE
WAYS



3 VIE
WAYS

I93

Miscelatore monocomando per doccia con deviatore a 3 posizioni (3 uscite ed 1 entrata) su piastra unica.
Single-lever shower mixer with 3-positions diverter (3 outlets and 1 inlet) on single plate

CR FIN 1 FIN 2

3 VIE
WAYS



3 VIE
WAYS

SOLO PARTE ESTERNA - EXPOSED COMPONENTS ONLY:

I93ZWB

Miscelatore a incasso per vasca/doccia con deviatore a 3 vie di tipo meccanico, su piastra rettangolare.
Built-in bath/shower mixer with 3-way mechanical diverter, on rectangular plate.

CR FIN 1 FIN 2

SOLO PARTE INTERNA - BUILT-IN COMPONENTS ONLY:

WBOX93Z

> pag 302



3 VIE
WAYS

SOLO PARTE ESTERNA - EXPOSED COMPONENTS ONLY:

I93ZPWB

Miscelatore a incasso per vasca/doccia con deviatore a 3 vie di tipo meccanico, su due piastre quadrate.
Built-in bath/shower mixer with 3-way mechanical diverter, on two square plates.

CR FIN 1 FIN 2

SOLO PARTE INTERNA - BUILT-IN COMPONENTS ONLY:

WBOX93Z

> pag 302



SOLO PARTE ESTERNA - EXPOSED COMPONENTS ONLY:

I97D3PWB

Set miscelatore a incasso a 3 vie per vasca/doccia su 3 piastre quadrate. Da completare con la seconda e la terza uscita acqua.
 3-way built-in bath/shower mixer set on 3 square plates. To be completed with the second and the third water outlet.

CR FIN 1 FIN 2



SOLO PARTE INTERNA - BUILT-IN COMPONENTS ONLY:

WBOX97D3

pag 308



SOLO PARTE ESTERNA - EXPOSED COMPONENTS ONLY:

I97D3WB

Set miscelatore a incasso a 3 vie per vasca/doccia su piastra rettangolare. Da completare con la seconda e la terza uscita acqua.
 3-way built-in shower mixer set on rectangular plate. To be completed with the second and the third water outlet.

CR FIN 1 FIN 2



SOLO PARTE INTERNA - BUILT-IN COMPONENTS ONLY:

WBOX97D3

pag 308

4/5 VIE WAYS



I94

Miscelatore monocomando per doccia, con deviatore a 4 posizioni (4 uscite ed 1 entrata) su piastra unica.
 Single-lever shower mixer with 4 positions diverter (4 outlets and 1 inlet) on single plate.

CR FIN 1 FIN 2

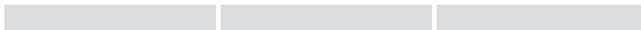

I95

Miscelatore monocomando per doccia, con deviatore a 5 posizioni (5 uscite ed una entrata) su piastra unica.
 Single-lever shower mixer with 5 positions diverter (5 outlets and 1 inlet) on single plate.

CR FIN 1 FIN 2

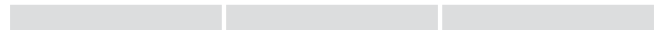

SALISCENDI E COLONNE DOCCIA - SLIDING RAILS AND SHOWER COLUMNS



I34A8CPAD20

Set doccia composto da: miscelatore esterno con deviatore vasca/doccia, soffione in abs 20x20cm con angoli arrotondati 356AD20X, colonna doccia in ottone telescopica, altezza asta regolabile 329A, doccetta in abs con 3 funzioni 318CP, flessibile 150 cm.

Shower set including: exposed mixer with bath/shower diverter, abs 20x20 cm shower head with rounded corners 356AD20X, telescopic brass shower column, with height-adjustable rod 329A, 3-function abs hand shower 318CP, 150 cm flexible hose.

CR

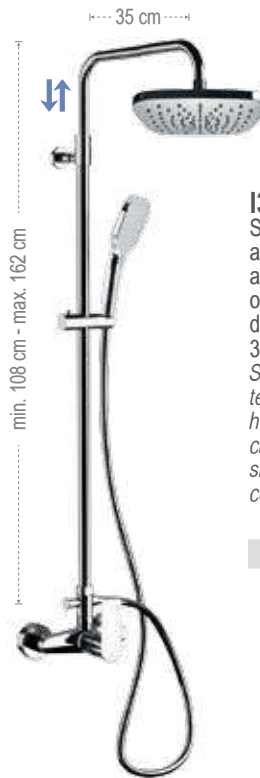

I37A8CPAD20

Set doccia composto da: miscelatore esterno con attacco superiore, soffione in abs 20x20cm con angoli arrotondati 356AD20X, colonna doccia in ottone telescopica, altezza asta regolabile, con deviatore 330A, doccetta in abs con 3 funzioni 318CP, flessibile 150 cm.

Shower mixer with 3/4" upper connection, telescopic shower column with diverter, ABS handshower 3 functions antilimestone (button to change the jets), 150 cm flexible hose and ABS shower head 20x20 cm, squared with rounded corners, with antilimestone silicon jets.

CR



317V317RV

Saliscendi cromato con asta minimale ovale dritta, flessibile in ottone 150 cm e doccetta ovale ad 1 funzione con getti anticalcare.

Sliding rail set with minimal oval rod, brass flexible hose 150 cm and 1 function antilimestone oval handshower.

CR



VANITY

UNA NATURALE ELEGANZA A NATURAL ELEGANCE



Il design della collezione di rubinetteria monocomando VANITY si contraddistingue per la sua grazia e per la continuità delle linee morbide che includono nel corpo del miscelatore sia la basetta che l'aeratore. Ne risulta un'unica figura scultorea, senza spigoli e intersezioni che dota gli arredi bagno di una naturale eleganza. La serie è dotata di cartuccia a dischi ceramici Ø 35 mm.

The design of VANITY single-lever faucet collection is characterized by its grace and by the continuity of its soft lines that include both the base and the aerator within the mixer body. The result is a unique sculptural figure, without edges and intersections that endows the bathroom furnishings with a natural elegance. The series is equipped with a Ø 35 mm ceramic disc cartridge.



VANITY



V15





V57XV



V10LBG - V11CFP

////////////////////// OPZIONI DI FINITURA - FINISHING OPTIONS ////////////////////////

CR		FIN 1		FIN 2	
	cromo <i>chrome</i>		nero opaco <i>matt black</i>		cromo nero spazzolato <i>brushed black chrome</i>
	CR		bianco opaco <i>matt white</i>		oro spazzolato <i>brushed gold</i>
			visual inox <i>visual steel</i>		
			NO		CFP
			BO		BG
			XV		

MISCELATORI LAVABO - WASHBASIN MIXERS



V10
Miscelatore monocomando lavabo, con scarico.
Single-lever basin mixer, with pop-up waste.



V11
Miscelatore monocomando lavabo, senza scarico.
Single-lever basin mixer, without waste.

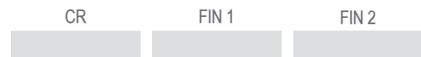

V12
senza scarico e senza foro sul corpo.
without waste and without body hole.



V10L
Miscelatore monocomando lavabo alto L, con scarico click-clack con troppo-pieno.
High single-lever basin mixer, with click-clack waste and overflow.



V11L
Miscelatore monocomando lavabo alto L, senza scarico.
High single-lever basin mixer, without waste.



V72C
Miscelatore monocomando lavabo senza scarico, con canna corta a "U", tipo lusso.
Single-lever basin mixer without waste, with short "U" spout, luxury type.



V15
Miscelatore monocomando a incasso per lavabo, con piastra in ottone.
Single-lever built-in basin mixer, with wall plate in brass.



V57
Miscelatore monocomando lavabo due fori senza scarico.
Two holes single-lever washbasin mixer.



V72
Miscelatore monocomando monoforo 90°, con canna alta a "U".
Single-lever sink mixer 90°, high "U" spout.



LAVABO BOX INCASSO - BUILT-IN BOX WASHBASIN MIXER



SOLO PARTE ESTERNA - EXPOSED COMPONENTS ONLY:

V15WB

Parti esterne per miscelatore monocomando a incasso per lavabo da abbinare al box incasso (non incluso). Piastra ultra-piatta. Lunghezza bocca 19 cm. *Exposed components for single-lever built-in basin mixer, with ultra-flat wall plate. To match with the built-in box (not included). Spout length 19 cm.*

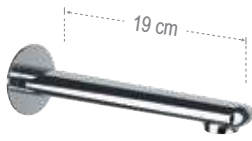
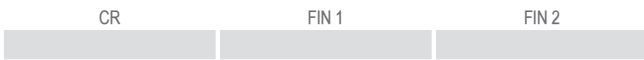

91V

Bocca incasso. *Built-in spout.*

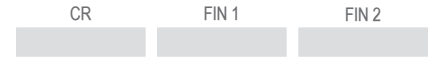

MISCELATORI BIDET - BIDET MIXERS



V20

Miscelatore monocomando bidet, con scarico. *Single-lever bidet mixer, with pop-up waste.*



V21

Miscelatore monocomando bidet, senza scarico. *Single-lever bidet mixer, without waste.*

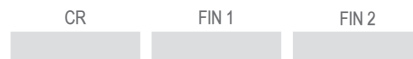

V22

Miscelatore monocomando bidet, senza scarico e senza foro sul corpo. *Single-lever bidet mixer, without waste and without body hole.*

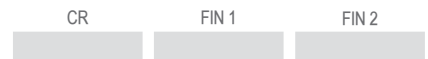

V65W

Miscelatore incasso per shut-off, kit con doccetta shut-off, supporto doccia/presa acqua, attacco conico da 1/2", tutto in ottone, flessibile cm 120. *Shut-off built-in shower mixer, kit including: shut-off, shower holder/water punch on flange all in brass, with 1/2 connection, handshower support and flexible cm 120.*



V60W

Miscelatore incasso per shut-off comprensivo di: doccetta shut-off, supporto doccia-presa acqua su piastra in ottone e flessibile cm 120. *Built-in shower mixer set including: shut-off, shower holder-water punch on plate, all in brass and shower flexible cm 120.*



V65B

Miscelatore incasso per shut-off, kit senza kit doccia. *Shut-off built-in shower mixer, without shower kit.*



MISCELATORI ESTERNI PER VASCA E DOCCIA - *EXPOSED MIXERS FOR BATH AND SHOWER*



V02
 Miscelatore vasca, con doccetta anticalcare a 4 funzioni con pulsante per cambio getti e flessibile 150 cm.
Exposed bath mixer, with 4 functions antilimestone handshower with button to change the jets flexible hose 150 cm.

CR



V38
 Monocomando doccia, con doccetta anticalcare a 4 funzioni con pulsante per cambio getti e flessibile 150 cm.
Exposed shower mixer, with 4 functions antilimestone handshower with button to change the jets flexible hose 150 cm.

CR



V05
 Miscelatore vasca, senza kit doccia.
Exposed bath mixer, without shower kit.

CR

FIN 1

FIN 2



V33
 Monocomando doccia, senza kit doccia.
Exposed shower mixer, without shower kit.

CR

FIN 1

FIN 2

MISCELATORI A INCASSO PER DOCCIA - *BUILT-IN MIXERS FOR SHOWER*



V30
 Miscelatore monocomando a incasso per doccia completo.
Complete single lever built-in shower mixer.

CR

FIN 1

FIN 2



V09HL

Miscelatore a incasso per vasca/doccia con deviatore a 2 vie a vitone ceramico. Per selezionare l'uscita desiderata, la manopola del deviatore deve essere ruotata da una posizione all'altra.

Built-in bath/shower mixer with 2-way diverter with ceramic head valve. To select the desired output, the diverter knob must be turned from one position to the other.



V09

Miscelatore monocomando a incasso con deviatore per vasca/doccia completo.

Complete single lever built-in bath/shower mixer with diverter.

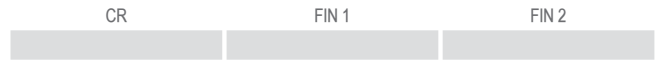

N09HB

Solo parte interna.
Built-in components only.



V09E

Solo parte esterna.
Exposed components only.



N09B

Solo parte interna.
Built-in components only.



V09E

Solo parte esterna.
Exposed components only.

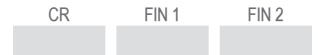

V09HRG

Miscelatore a incasso per vasca/doccia con deviatore a 2 vie con vitone ceramico, su piastra rettangolare, montaggio orizzontale. Per selezionare l'uscita desiderata, la manopola del deviatore deve essere ruotata da una posizione all'altra.

Built-in bath/shower mixer with 2-way diverter with ceramic head valve, on rectangular plate, horizontal mounting. To select the desired output, the diverter knob must be turned from one position to the other.



V92

Miscelatore monocomando a incasso per doccia, con deviatore a due posizioni (due uscite ed una entrata) su piastra unica.

Single-lever built-in shower mixer with 2 positions diverter (2 outlets and 1 inlet) on single plate.

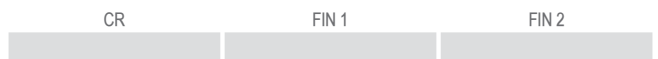

N09HRB

Solo parte interna.
Built-in components only.



V09GE

Solo parte esterna.
Exposed components only.



2 VIE
WAYS



SOLO PARTE ESTERNA - EXPOSED COMPONENTS ONLY:

V92ZWB

Miscelatore a incasso per vasca/doccia con deviatore a 2 vie di tipo meccanico, su piastra rettangolare.
Built-in bath/shower mixer with 2-way mechanical diverter, on rectangular plate.

CR FIN 1 FIN 2



SOLO PARTE INTERNA - BUILT-IN COMPONENTS ONLY:

WBOX92Z

> pag 300



SOLO PARTE ESTERNA - EXPOSED COMPONENTS ONLY:

V92ZPWB

Miscelatore a incasso per vasca/doccia con deviatore a 2 vie di tipo meccanico, su due piastre tonde.
Built-in bath/shower mixer with 2-way mechanical diverter, on two round plates.

CR FIN 1 FIN 2

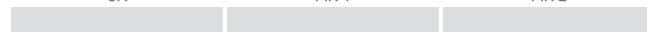

SOLO PARTE INTERNA - BUILT-IN COMPONENTS ONLY:

WBOX92Z

> pag 300

3 VIE
WAYS



SOLO PARTE ESTERNA - EXPOSED COMPONENTS ONLY:

V93ZWB

Miscelatore a incasso per vasca/doccia con deviatore a 3 vie di tipo meccanico, su piastra rettangolare.
Built-in bath/shower mixer with 3-way mechanical diverter, on rectangular plate.

CR FIN 1 FIN 2

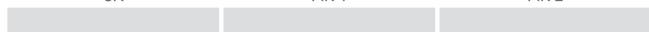

SOLO PARTE INTERNA - BUILT-IN COMPONENTS ONLY:

WBOX93Z

> pag 302



SOLO PARTE ESTERNA - EXPOSED COMPONENTS ONLY:

V93ZPWB

Miscelatore a incasso per vasca/doccia con deviatore a 3 vie di tipo meccanico, su due piastre tonde.
Built-in bath/shower mixer with 3-way mechanical diverter, on two round plates.

CR FIN 1 FIN 2

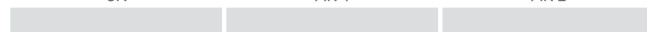

SOLO PARTE INTERNA - BUILT-IN COMPONENTS ONLY:

WBOX93Z

> pag 302

3 VIE
WAYS



V93

Miscelatore monocomando per doccia con deviatore a tre vie (una entrata e tre uscite) su unica piastra.
Single lever built-in shower mixer with three ways diverter (1 inlet and 3 outlets) on single plate.

CR FIN 1 FIN 2

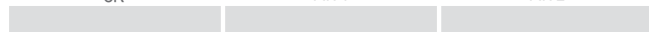



4/5 VIE WAYS



V94

Miscelatore monocomando per doccia, con deviatore a 4 posizioni (4 uscite ed 1 entrata) su piastra unica.

Single-lever shower mixer with 4 positions diverter (4 outlets and 1 inlet,) on single plate.

CR

FIN 1

FIN 2

V95

Miscelatore monocomando per doccia, con deviatore a 5 posizioni (5 uscite ed una entrata) su piastra unica.

Single-lever shower mixer with 5 positions diverter (5 outlets and 1 inlet) on single plate.

CR

FIN 1

FIN 2

COLONNE DOCCIA - SHOWER COLUMNS

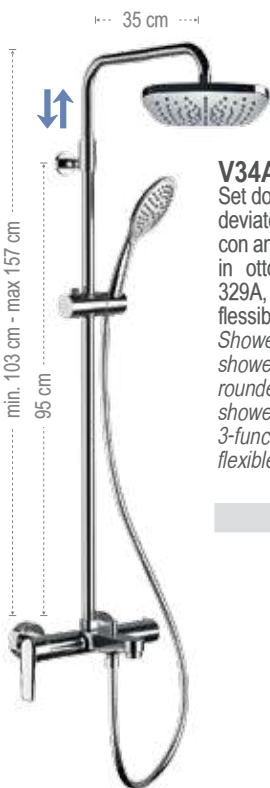

V34A5P3AD20

Set doccia composto da: miscelatore esterno con deviatore vasca/doccia, soffione in abs 20x20cm con angoli arrotondati 356AD20X, colonna doccia in ottone telescopica, altezza asta regolabile 329A, doccetta in abs con 3 funzioni 315P3, flessibile 150 cm.

Shower set including: exposed mixer with bath/shower diverter, abs 20x20 cm shower head with rounded corners 356AD20X, telescopic brass shower column, with height-adjustable rod 329A, 3-function abs hand shower 315P3, 150 cm flexible hose.

CR

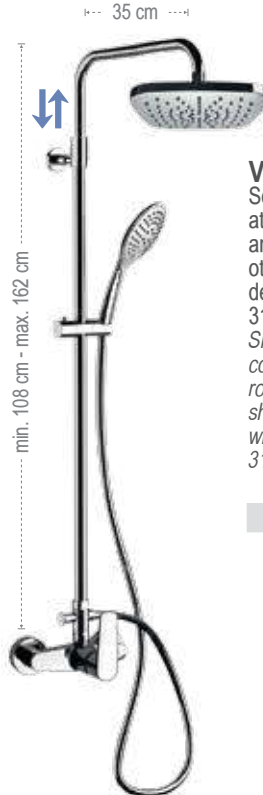

V37A5P3AD20

Set doccia composto da: miscelatore esterno con attacco superiore, soffione in abs 20x20cm con angoli arrotondati 356AD20X, colonna doccia in ottone telescopica, altezza asta regolabile, con deviatore 330A, doccetta in abs con 3 funzioni 315P3, flessibile 150 cm.

Shower set including: exposed mixer with upper connection, abs 20x20 cm shower head with rounded corners 356AD20X, telescopic brass shower column, with height-adjustable rod, with diverter 330A, 3-function abs hand shower 315P3, 150 cm flexible hose.

CR



DREAM

UN SOGNO CHE SI AVVERA
A DREAM COME TRUE



Dream è l'espressione di un design chiaro e pulito, attento ai dettagli che fanno la differenza tra un prodotto normale ed uno di successo. Gli amanti dei particolari noteranno sicuramente che il corpo è sviluppato da una forma ellittica che sale verso l'alto con uno sforno esterno; in questo modo abbiamo eliminato esteticamente il raggio di giunzione tra corpo e bocca. La serie è dotata di cartuccia a dischi ceramici Ø 35 mm.

Dream is the expression of a clear and clean design, attentive to the details that make the difference between a normal product and a successful one. Lovers of details can definitely notice that the body is developed on an elliptically shape going upward with an external mould shape, thus aesthetically removing the junction radius between body and spout. The series is equipped with a Ø 35 mm ceramic disc cartridge



DREAM





D11L



D15PXV



D11LNO - D11NO

OPZIONI DI FINITURA - FINISHING OPTIONS

CR		FIN 1		FIN 2	
	cromo chrome		nero opaco matt black		
	CR		bianco opaco matt white	NO	
			visual inox visual steel	BO	
				XV	

MISCELATORI LAVABO - WASHBASIN MIXERS



D10
Miscelatore monocomando lavabo, con scarico.
Single-lever basin mixer, with pop-up waste.



D10L
Miscelatore monocomando lavabo alto L, con scarico click-clack con troppo-pieno.
L high single-lever basin mixer, with click-clack waste and overflow



D72C
Miscelatore monocomando lavabo senza scarico, con canna corta a "U" girevole, tipo lusso.
Single-lever basin mixer without waste, with short "U" swivel spout, luxury type.



D12
Miscelatore monocomando lavabo, senza scarico e senza foro sul corpo.
Single-lever basin mixer, without waste and without body hole.



D11L
Miscelatore monocomando lavabo alto L, senza scarico.
L high single-lever basin mixer, without waste.



D72
Miscelatore monocomando monoforo 90°, con canna alta a "U" girevole.
Single-lever sink mixer 90°, high "U" swivel spout.



D15
Miscelatore monocomando a incasso per lavabo, con piastra in ottone.
Single-lever built-in basin mixer, with wall plate in brass.

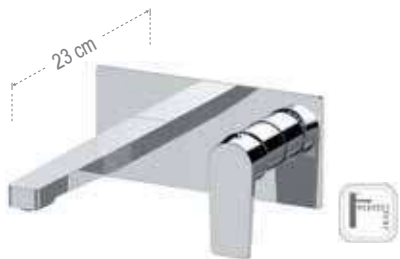

D15L
Miscelatore monocomando a incasso per lavabo, con piastra in ottone, bocca 23 cm.
Single-lever built-in basin mixer, with wall plate in brass, spout 23 cm.



D57
Miscelatore monocomando lavabo due fori senza scarico.
Two holes single-lever washbasin mixer without waste.



LAVABO A MURO CON BOX INCASSO - WALL WASHBASIN MIXER WITH BUILT-IN BOX



SOLO PARTE ESTERNA - EXPOSED COMPONENTS ONLY:

SOLO PARTE ESTERNA - EXPOSED COMPONENTS ONLY:

D15WB

Parti esterne per miscelatore monocomando a incasso per lavabo da abbinare al box incasso (non incluso). Piastra ultra-piatta. Lunghezza bocca 18 cm. *Exposed components for single-lever built-in basin mixer, with ultra-flat wall plate. To match with the built-in box (not included). Spout length 18 cm.*

D15PWB

Parti esterne per miscelatore monocomando a incasso per lavabo da abbinare al box incasso (non incluso). Su due piastre quadrate separate. Lunghezza bocca 18 cm. *Exposed components for single-lever built-in basin mixer, with two separate square plates. To match with the built-in box (not included). Spout length 18 cm.*

CR FIN 1

CR FIN 1

D15LWB

Idem sopra, con lunghezza bocca 23 cm. *Same as above, with spout length 23 cm.*

D15PLWB

Idem sopra, con lunghezza bocca 23 cm. *Same as above, with spout length 23 cm.*

CR FIN 1

CR FIN 1

SOLO PARTE INTERNA - BUILT-IN COMPONENTS ONLY:

SOLO PARTE INTERNA - BUILT-IN COMPONENTS ONLY:

WBOX15

WBOX15

MISCELATORI BIDET - BIDET MIXERS



D20

Miscelatore monocomando bidet, con scarico. *Single-lever bidet mixer, with pop-up waste.*

D65W

Miscelatore incasso per shut-off con supporto doccia/presa acqua integrato, attacco conico da 1/2", tutto in ottone, con doccetta shut-off, flessibile doccia cm 120. *Built-in shower mixer with integrated shower holder/water punch on flange all in brass, with 1/2 connection, including shut-off and flexible cm 120.*

D60

Miscelatore incasso per shut-off comprensivo di: doccetta shut-off, supporto doccia-presa acqua su piastra in ottone e flessibile doccia cm 120. *Built-in shower mixer set including: shut-off, shower holder water punch on plate all in brass and shower flexible cm 120.*

CR FIN 1

CR FIN 1

CR FIN 1

D22

Miscelatore monocomando bidet, senza scarico e senza foro sul corpo. *Single-lever bidet mixer, without waste and without body hole.*

D65B

Miscelatore incasso per shut-off con supporto doccia/presa acqua integrato, attacco conico da 1/2", tutto in ottone, senza kit doccia. *Built-in shower mixer with integrated shower holder/water punch on flange all in brass, with 1/2 connection, without shower kit.*

CR FIN 1

CR FIN 1

DREAM

BOCCE - SPOUTS

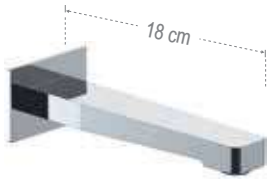

91DR

Bocca incasso per miscelatore vasca/doccia 18cm.
Built-in spout for bath/shower mixer cm 18.

CR

FIN 1

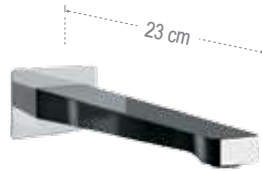

91DL

Bocca incasso per miscelatore vasca/doccia 23 cm.
Built-in spout for bath/shower mixer cm. 23

CR

FIN 1

MISCELATORI ESTERNI PER VASCA E DOCCIA - EXPOSED MIXERS FOR BATH AND SHOWER



D028CP

Miscelatore vasca con flessibile cm 150 e doccetta a 4 funzioni con getti in silicone anticalcare.
Wall mounted bath mixer with flexible cm 150 and 4 functions antilimestone handshower with silicon jets.

CR



D078CP

Miscelatore monocomando bordo vasca con deviatore a leva integrato nella bocca minimale e doccetta in ABS cromato a 4 funzioni.
Single lever deck bath mixer with lever diverter integrated on the minimal spout and pull-out 4 functions chrome plated ABS handshower.

CR



D07UF8CP

Miscelatore monocomando bordo vasca con deviatore integrato nel miscelatore, bocca a cascata e doccetta estraibile in ABS cromato a 4 funzioni.
Single lever deck bath mixer with diverter integrated on the mixer, with waterfall spout and pull-out 4 functions chrome plated ABS handshower.

CR



D05

Miscelatore vasca, senza kit doccia.
Wall mounted bath mixer, without shower kit.

CR

FIN 1



D388CP

Miscelatore doccia con flessibile cm 150 e doccetta a 4 funzioni con getti in silicone anticalcare.
Exposed shower mixer with flexible hose cm 150 and 4 functions antilimestone handshower with silicon jets.

CR



D33

Miscelatore doccia, senza kit doccia.
Exposed shower mixer, without shower kit.

CR

FIN 1

MISCELATORI A INCASSO PER DOCCIA - BUILT-IN MIXERS FOR SHOWER



D30
Miscelatore monocomando a incasso per doccia completo.
Complete single lever built-in shower mixer.

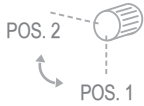

D09HL
Miscelatore a incasso per vasca/doccia con deviatore a 2 vie a vitone ceramico. Per selezionare l'uscita desiderata, la manopola del deviatore deve essere ruotata da una posizione all'altra.
Built-in bath/shower mixer with 2-way diverter with ceramic head valve. To select the desired output, the diverter knob must be turned from one position to the other.



D09
Miscelatore monocomando a incasso con deviatore per vasca/doccia completo.
Complete single lever built-in bath/shower mixer with diverter.



N09HB
Solo parte interna.
Built-in components only.



D09E
Solo parte esterna.
Exposed components only.



N09B
Solo parte interna.
Built-in components only.



D09E
Solo parte esterna.
Exposed components only.

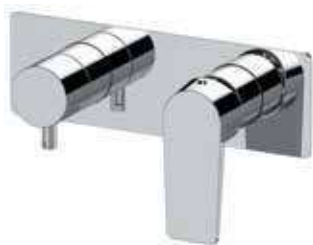

SOLO PARTE ESTERNA - EXPOSED COMPONENTS ONLY:

D92ZWB
Miscelatore a incasso per vasca/doccia con deviatore a 2 vie di tipo meccanico, su piastra rettangolare.
Built-in bath/shower mixer with 2-way mechanical diverter, on rectangular plate.



SOLO PARTE ESTERNA - EXPOSED COMPONENTS ONLY:

D92ZPWB
Miscelatore a incasso per vasca/doccia con deviatore a 2 vie di tipo meccanico, su due piastre quadrate.
Built-in bath/shower mixer with 2-way mechanical diverter, on two square plates.



SOLO PARTE INTERNA - BUILT-IN COMPONENTS ONLY:

WBOX92Z > pag 300

SOLO PARTE INTERNA - BUILT-IN COMPONENTS ONLY:

WBOX92Z > pag 300

METRICA
ENERGY / ECO
SLASH / DOT
ABSOLUTE
INFINITY
VANITY
DREAM
CLASS LINE
WINNER / ECO
LIBERTY

2 VIE
WAYS



2 VIE
WAYS

2 VIE
WAYS

D09HRG

Miscelatore a incasso per vasca/doccia con deviatore a 2 vie con vitone ceramico, su piastra rettangolare, montaggio orizzontale. Per selezionare l'uscita desiderata, la manopola del deviatore deve essere ruotata da una posizione all'altra.

Built-in bath/shower mixer with 2-way diverter with ceramic head valve, on rectangular plate, horizontal mounting. To select the desired output, the diverter knob must be turned from one position to the other.

CR

FIN 1



D92

Miscelatore monocomando a incasso per doccia, con deviatore a due posizioni (due uscite ed una entrata) su piastra unica.

Single-lever built-in shower mixer with 2 positions diverter (2 outlets and 1 inlet) on single plate.

CR

FIN 1



N09HRB

Solo parte interna.

Built-in components only.



CR

FIN 1



D09GE

Solo parte esterna.

Exposed components only.

CR

FIN 1



3 VIE
WAYS

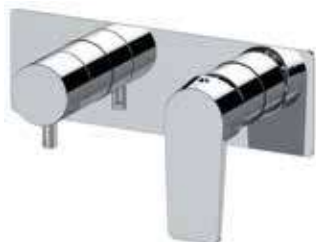

3 VIE
WAYS



3 VIE
WAYS

SOLO PARTE ESTERNA - EXPOSED COMPONENTS ONLY:

D93ZWB

Miscelatore a incasso per vasca/doccia con deviatore a 3 vie di tipo meccanico, su piastra rettangolare.

Built-in bath/shower mixer with 3-way mechanical diverter, on rectangular plate.

CR

FIN 1



SOLO PARTE ESTERNA - EXPOSED COMPONENTS ONLY:

D93ZPWB

Miscelatore a incasso per vasca/doccia con deviatore a 3 vie di tipo meccanico, su due piastre tonde.

Built-in bath/shower mixer with 3-way mechanical diverter, on two round plates.

CR

FIN 1



SOLO PARTE INTERNA - BUILT-IN COMPONENTS ONLY:

WBOX93Z

pag 302

SOLO PARTE INTERNA - BUILT-IN COMPONENTS ONLY:

WBOX93Z

pag 302



3 VIE
WAYS

D93

Miscelatore monocomando per doccia con deviatore a tre vie (una entrata e tre uscite) su unica piastra.

Single lever built-in shower mixer with three ways diverter (1 inlet and 3 outlets) on single plate.

CR

FIN 1





D09HRGNO

SALISCENDI E COLONNE DOCCIA - SLIDING RAILS AND SHOWER COLUMNS

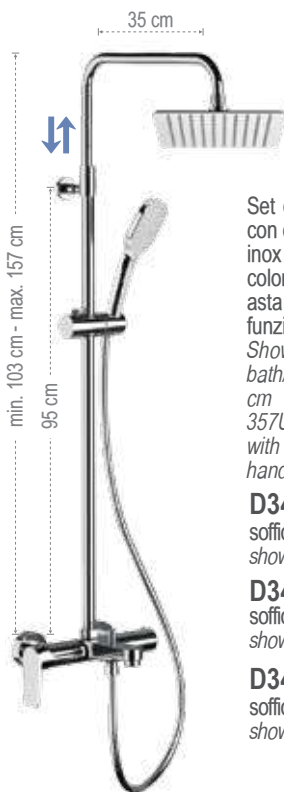

Set doccia composto da: miscelatore esterno con deviatore vasca/doccia, soffione in acciaio inox con angoli arrotondati 357UFD20X, colonna doccia in ottone telescopica, altezza asta regolabile 329A, doccetta in abs con 3 funzioni 318CP, flessibile 150 cm.

Shower set including: exposed mixer with bath/shower diverter, stainless steel 20x20 cm shower head with rounded corners 357UFD20X, telescopic brass shower column, with height-adjustable rod 329A, 3-function abs hand shower 318CP, 150 cm flexible hose.

D34A8CPUFD20

soffione da 20x20 cm
shower head 20x20

CR

D34A8CPUFD25

soffione da 25x25 cm
shower head 25x25 cm

CR

D34A8CPUFD30

soffione da 30x30 cm
shower head 30x30 cm

CR



D37A8CPAD20

Set doccia composto da: miscelatore esterno con attacco superiore, soffione in abs 20x20cm con angoli arrotondati 356AD20X, colonna doccia in ottone telescopica, altezza asta regolabile, con deviatore 330A, doccetta in abs con 3 funzioni 318CP, flessibile 150 cm.

Shower set including: exposed mixer with upper connection, abs 20x20 cm shower head with rounded corners 356AD20X, telescopic brass shower column, with height-adjustable rod, with diverter 330A, 3-function abs hand shower 318CP, 150 cm flexible hose.

CR



CLASS LINE

COMFORT E LINEE MODERNE
COMFORT AND MODERN LINES



Il design della serie gioca sul parallelismo tra leva e bocca di erogazione rendendo le superfici completamente piatte e riflettenti per poi fonderle con raggature più morbide, in una perfetta unione tra tondo e quadro. Una serie completa che mette in evidenza caratteristiche tecniche e di design esemplari. La serie è dotata di cartuccia a dischi ceramici Ø 35 mm.

The design of the series plays on parallelism between the lever and the outlet spout, making the surfaces completely flat, reflective and then joining them with softer radius, in a perfect matching between round and squared. at a reasonable price. A complete set of faucets that highlights technical and design features. The series is equipped with a Ø 35 mm ceramic disc cartridge.



CLASS LINE



CLASS LINE

L08



L15



L15PXV



L11LXLNO - L11XV - L12LABO

OPZIONI DI FINITURA - FINISHING OPTIONS

CR		FIN 1		FIN 2	
	cromo chrome		nero opaco matt black		
	CR		bianco opaco matt white	NO	
			visual inox visual steel	BO	
				XV	

MISCELATORI LAVABO - WASHBASIN MIXERS



L10
Miscelatore monocomando lavabo, con scarico.
Single-lever basin mixer, with pop-up waste.



L10P
Miscelatore monocomando lavabo, con scarico in plastica.
Single-lever basin mixer, with plastic waste.



L11
Miscelatore monocomando lavabo, senza scarico.
Single-lever basin mixer, without waste.



L12
senza scarico e senza foro sul corpo.
without waste and without body hole.



L10L
Miscelatore monocomando lavabo alto L, con scarico.
L high single lever basin mixer, with pop-up waste.



L11L
Miscelatore monocomando lavabo alto L, senza scarico.
L high single lever basin mixer, without waste.



L12L
Miscelatore monocomando lavabo alto L, senza scarico e senza foro sul corpo.
L high single lever basin mixer, without waste and without body hole.



L10LACC
Miscelatore monocomando per lavabo, modello "A" altezza media, scarico click-clack con troppo-pieno incluso.
Single-lever basin mixer, model "A" medium height, click-clack waste with overflow included.



L12LA
Miscelatore monocomando per lavabo, modello "A" altezza media, senza scarico e senza foro sul corpo.
Single-lever basin mixer, model "A" medium height, without pop-up waste and with no rear hole.



L72
Miscelatore monocomando monoforo 90°, con canna "U" girevole.
Single-lever sink mixer 90°, high swivel "U" spout.





L10LXL

Miscelatore monocomando lavabo alto XL, con scarico click-clack con troppo-pieno.
XL high basin mixer, with click-clack waste and overflow.

CR FIN 1



L11LXL

Miscelatore monocomando lavabo alto XL, senza scarico.
XL high basin mixer, without waste.

CR FIN 1



L72C

Miscelatore monocomando lavabo senza scarico, con canna corta a "U" girevole, tipo lusso.
Single-lever basin mixer without waste, with short "U" swivel spout, luxury type.

CR FIN 1

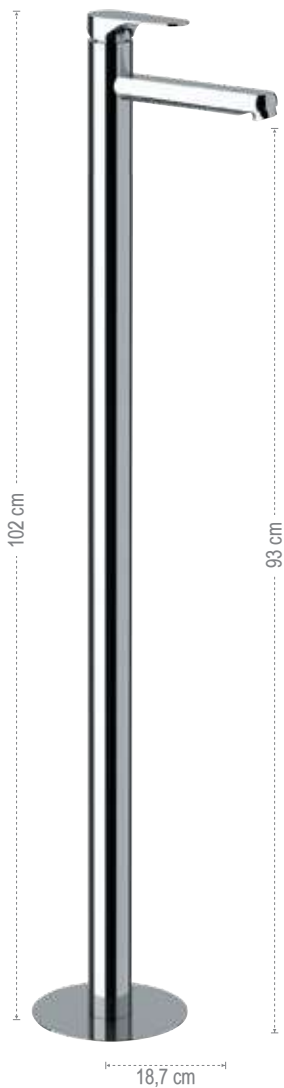

L18

Miscelatore monocomando lavabo da terra con scarico click-clack, prodotto completo.
Single-lever mixer for floor mounting with click-clack waste, complete product.

CR FIN 1

Q08FIS2

Solo parte interna.
Built-in components only.

CR

L18E

Solo parti esterne.
Exposed components only.

CR FIN 1 FIN 2



L57

Miscelatore monocomando lavello due fori senza scarico.
Two holes single-lever mixer without waste.

CR FIN 1



L15

Miscelatore monocomando a incasso per lavabo, con piastra rettangolare in ottone.
Single-lever built-in basin mixer, with rectangular wall plate in brass.

CR FIN 1

L15L

Miscelatore monocomando a incasso per lavabo, con piastra rettangolare in ottone, bocca 23 cm.
Single-lever built-in basin mixer, with rectangular wall plate in brass, spout 23 cm.

CR FIN 1

LAVABO A MURO CON BOX INCASSO - WALL WASHBASIN MIXER WITH BUILT-IN BOX



SOLO PARTE ESTERNA - EXPOSED COMPONENTS ONLY:

L15WB

Parti esterne per miscelatore monocomando a incasso per lavabo da abbinare al box incasso (non incluso). Piastra ultra-piatta. Lunghezza bocca 18 cm.
Exposed components for single-lever built-in basin mixer, with ultra-flat wall flange. To match with the built-in box (not included). Spout length 18 cm.

CR FIN 1

L15LWB

Idem sopra, con lunghezza bocca 23 cm.
Same as above, with spout length 23 cm.

CR FIN 1

SOLO PARTE ESTERNA - EXPOSED COMPONENTS ONLY:

L15PWB

Parti esterne per miscelatore monocomando a incasso per lavabo da abbinare al box incasso (non incluso). Su due piastre quadrate separate. Lunghezza bocca 18 cm.
Exposed components for single-lever built-in basin mixer, with two separate square plates. To match with the built-in box (not included). Spout length 18 cm.

CR FIN 1

L15PLWB

Idem sopra, con lunghezza bocca 23 cm.
Same as above, with spout length 23 cm.

CR FIN 1

SOLO PARTE INTERNA - BUILT-IN COMPONENTS ONLY:

WBOX15

SOLO PARTE INTERNA - BUILT-IN COMPONENTS ONLY:

WBOX15

BOCCHIE - SPOUTS



91LD

Bocca incasso con deviatore integrato.
Built-in spout with diverter.

CR FIN 1



91L

Bocca incasso per miscelatore vasca/doccia 18 cm.
Built-in spout for bath/shower mixer cm 18.

CR FIN 1

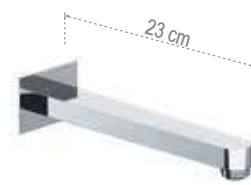

91LL

Bocca incasso per miscelatore vasca/doccia 23 cm.
Built-in spout for bath/shower mixer cm 23.

CR FIN 1

MISCELATORI BIDET - BIDET MIXERS

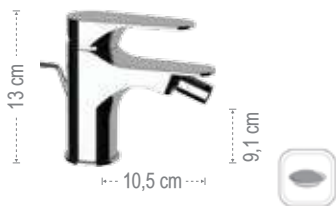

L20

Miscelatore monocomando bidet con scarico.
Single-lever bidet mixer, with pop-up waste.

CR FIN 1



L20P

Miscelatore monocomando bidet con scarico in plastica.
Single-lever bidet mixer, with plastic waste.

CR



L21

Miscelatore monocomando bidet senza scarico.
Single-lever bidet mixer, without waste.

CR FIN 1



L22

Miscelatore monocomando per bidet, senza scarico e senza foro posteriore sul corpo.
Single-lever bidet mixer, without waste and without rear body hole.

CR FIN 1



L65W

Miscelatore incasso per shut-off con supporto doccia/presa acqua integrato, attacco conico da 1/2", tutto in ottone, con doccetta shut-off e flessibile cm 120.
Built-in shower mixer with integrated shower holder/water punch on flange all in brass, with 1/2 connection, with shut-off and flexible hose cm 120.

CR FIN 1



LC31DP

Miscelatore monocomando esterno doccia, interasse 100 mm, con doccetta shut-off e flessibile cm 120.
Wall mounted single lever shower mixer, interaxis 100 mm, with shut-off and flexible hose cm 120.

CR



L60W

Miscelatore incasso per shut-off comprensivo di: doccetta shut-off, supporto doccia/presa acqua su piastra in ottone e flessibile cm 120.
Built-in shower mixer set including: shut-off, shower holder water punch on flange all in brass and flexible hose cm 120.

CR FIN 1



L65B

Miscelatore incasso per shut-off con supporto doccia/presa acqua integrato, attacco conico da 1/2", tutto in ottone, senza kit doccia.
Built-in shower mixer with integrated shower holder/water punch on flange all in brass, with 1/2 connection, without shower kit.

CR FIN 1



LC31

Miscelatore monocomando esterno doccia, interasse 100 mm, senza kit doccia.
Wall mounted single lever shower mixer, interaxis 100 mm, without shower kit.

CR FIN 1



L10SHW

Miscelatore monocomando lavabo con doccetta shut-off e scarico click-clack con troppo pieno.
Single-lever basin mixer with handshower shut-off and click-clack waste with overflow.

CR FIN 1



L63

Miscelatore incasso per shut-off.
Built-in shut-off mixer.

CR FIN 1

MISCELATORI ESTERNI PER VASCA E DOCCIA - *EXPOSED MIXERS FOR BATH AND SHOWER*



L03

Miscelatore monocomando per vasca, con flessibile cm 150 e doccetta a 4 funzioni con getti anticalcare e supporto snodato.
Single lever bath mixer with diverter, with flexible hose cm 150 and 4 functions antilimestone handshower and swivel shower holder.

CR



L02

Miscelatore vasca con deviatore integrato, con flessibile cm 150 e doccetta a 4 funzioni con getti anticalcare e supporto snodato.
Wall mounted bath mixer with integrated diverter, with flexible hose cm 150 and 4 functions antilimestone handshower and swivel shower holder.

CR



L49

Miscelatore lavabo/vasca con canna fusa lunghezza 30 cm con deviatore integrato, con flessibile cm 150 e doccetta in ABS a 4 funzioni con anticalcare e supporto snodato.
Wall mounted basin/bath single lever mixer with long casted spout length 30 cm and integrated diverter, with brass flexible hose cm 150 and 4 functions ABS antilimestone handshower and swivel shower holder.

CR

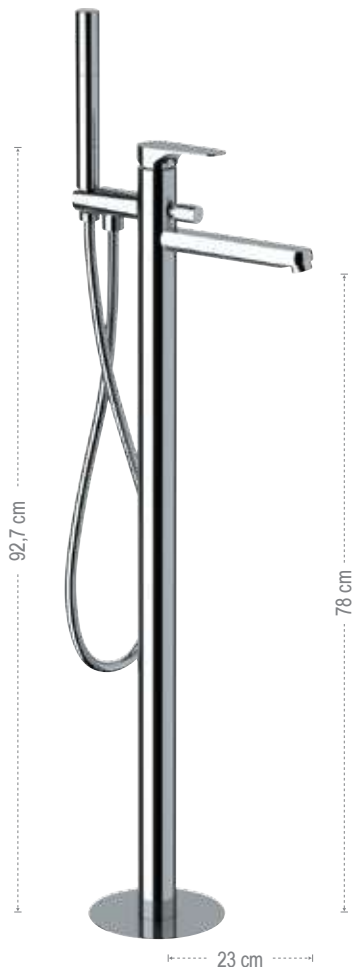

L08

Miscelatore bordo vasca da pavimento, con deviatore e kit doccia in ottone doccetta ad 1 funzione e flessibile 150 cm, senza scarico.
Single-lever bath mixer floor mounting, with diverter and brass shower kit, 1 function handshower and flexible hose 150 cm, without waste.

CR

FIN 1

Q08FIS2

Solo parte interna.
Built-in components only.

CR

L08E

Solo parti esterne.
Exposed components only.

CR

FIN 1



L39
Miscelatore doccia esterno con flessibile cm 150 e doccetta a 4 funzioni con getti in silicone anticalcare e supporto snodato.
Exposed shower mixer with flexible cm 150 and 4 functions antilimescale handshower with silicon jets and swivel shower holder.

CR



L31
Miscelatore doccia esterno, senza kit doccia.
Exposed shower mixer, without shower kit.

CR

FIN 1



L33
Miscelatore monocomando doccia esterno con leva frontale, senza kit doccia, con attacco 1/2".
Wall mounted single-lever shower mixer with frontal lever, without shower kit, 1/2" connection.

CR



L05
Miscelatore vasca con deviatore integrato, senza kit doccia.
Wall mounted bath mixer with integrated diverter, without shower kit.

CR

FIN 1



L07
Miscelatore monocomando bordo vasca con deviatore a leva integrato nella bocca minimale in ottone e doccetta cromata estraibile a 4 funzioni.
Single lever deck bath mixer with lever diverter integrated on the spout, with minimal brass spout and 4 functions ABS handshower.

CR



L07UF
Miscelatore monocomando bordo vasca con deviatore integrato nel miscelatore, bocca a cascata e doccetta estraibile a 4 funzioni in ABS.
Single lever deck bath mixer with diverter integrated on the mixer, with waterfall spout and pull-out 4 functions ABS handshower.

CR



L46
Miscelatore lavabo/vasca con canna fusa lunghezza 30 cm con deviatore integrato, senza kit doccia.
Wall mounted basin/bath single lever mixer with long casted spout length 30 cm and integrated diverter, without shower kit.

CR

FIN 1

MISCELATORI A INCASSO PER VASCA - *BUILT-IN MIXERS FOR BATH*



2 VIE
WAYS



SOLO PARTE ESTERNA - EXPOSED COMPONENTS ONLY:

L53D2WB

Set a incasso a 2 vie per vasca su piastra unica rettangolare.
2-way built-in set for bathtub on a single rectangular plate.

CR

FIN 1



SOLO PARTE ESTERNA - EXPOSED COMPONENTS ONLY:

L53D2PWB

Set a incasso a 2 vie per vasca su piastre tonde separate.
2-way built-in set for bathtub on separate round plates.

CR

FIN 1

SOLO PARTE INTERNA - BUILT-IN COMPONENTS ONLY:

WBOX97D2

pag 304

SOLO PARTE INTERNA - BUILT-IN COMPONENTS ONLY:

WBOX97D2

pag 304



2 VIE
WAYS



SOLO PARTE ESTERNA - EXPOSED COMPONENTS ONLY:

L54D2WB

Set miscelatore a incasso a 2 vie per vasca/doccia su piastra unica rettangolare. Da completare con la seconda uscita.
2-way built-in mixer set for bathtub / shower on single rectangular plate. To be completed with the second water outlet.

CR

FIN 1



SOLO PARTE ESTERNA - EXPOSED COMPONENTS ONLY:

L54D2PWB

Set miscelatore a incasso a 2 vie per vasca/doccia su 3 piastre tonde. Da completare con la seconda uscita acqua.
2-way built-in mixer set for bathtub / shower on 3 round plates. To be completed with the second water outlet.

CR

FIN 1

SOLO PARTE INTERNA - BUILT-IN COMPONENTS ONLY:

WBOX97D2

pag 304

SOLO PARTE INTERNA - BUILT-IN COMPONENTS ONLY:

WBOX97D2

pag 304



3 VIE
WAYS



SOLO PARTE ESTERNA - EXPOSED COMPONENTS ONLY:

L54D3WB

Set miscelatore a incasso a 3 vie per vasca/doccia su piastra unica rettangolare. Da completare con la seconda e la terza uscita acqua.
3-way built-in mixer set for bathtub / shower on single rectangular plate. To be completed with the second and the third water outlet.

CR

FIN 1



SOLO PARTE ESTERNA - EXPOSED COMPONENTS ONLY:

L54D3PWB

Set miscelatore a incasso a 3 vie per vasca/doccia su 3 piastre tonde. Da completare con la seconda e la terza uscita acqua.
3-way built-in mixer set for bathtub / shower on 3 separate round plates. To be completed with the second and the third water outlet.

CR

FIN 1

SOLO PARTE INTERNA - BUILT-IN COMPONENTS ONLY:

WBOX97D3

pag 308

SOLO PARTE INTERNA - BUILT-IN COMPONENTS ONLY:

WBOX97D3

pag 308

Set doccia acquistabile separatamente a pagina 427 - *Shower set can be purchased separately on page 427*



L54D2WB

MISCELATORI A INCASSO PER DOCCIA - BUILT-IN MIXERS FOR SHOWER



L30
Miscelatore monocomando a incasso per doccia completo.
Complete single lever built-in shower mixer.

CR FIN 1



L30L
Monocomando doccia incasso con piastra lusso Class Line completo.
Complete built-in shower mixer with deluxe Class Line plate.

CR FIN 1



L09
Miscelatore monocomando a incasso con deviatore per vasca/doccia completo.
Complete single lever built-in bath/shower mixer with diverter.

CR FIN 1



L09L
Monocomando vasca/doccia incasso con deviatore con piastra lusso Class Line completo.
Complete built-in bath/shower mixer with diverter with deluxe Class Line Plate.

CR FIN 1

N09B
Solo parte interna.
Built-in components only.

CR



FIN 1

L09E
Solo parte esterna.
Exposed components only.

CR

FIN 1

N09B
Solo parte interna.
Built-in components only.

CR



FIN 1

L09LE
Solo parte esterna.
Exposed components only.

CR

FIN 1



L09H
Miscelatore a incasso per vasca/doccia con deviatore a 2 vie a vitone ceramico, su piastra tonda. Per selezionare l'uscita desiderata, la manopola del deviatore deve essere ruotata da una posizione all'altra.
Built-in bath/shower mixer with 2-way diverter with ceramic head valve, on round wall plate. To select the desired output, the diverter knob must be turned from one position to the other.

CR FIN 1



L09HG
Miscelatore a incasso per vasca/doccia con deviatore a 2 vie a vitone ceramico, su piastra rettangolare. Per selezionare l'uscita desiderata, la manopola del deviatore deve essere ruotata da una posizione all'altra.
Built-in bath/shower mixer with 2-way diverter with ceramic head valve, on rectangular wall plate. To select the desired output, the diverter knob must be turned from one position to the other.

CR FIN 1

N09HB
Solo parte interna.
Built-in components only.

CR



FIN 1

L09E
Solo parte esterna.
Exposed components only.

CR

FIN 1

N09HB
Solo parte interna.
Built-in components only.

CR



FIN 1

L09GE
Solo parte esterna.
Exposed components only.

CR

FIN 1



2 VIE WAYS



2 VIE WAYS

L09HRG

Miscelatore a incasso per vasca/doccia con deviatore a 2 vie con vitone ceramico, su piastra rettangolare, montaggio orizzontale. Per selezionare l'uscita desiderata, la manopola del deviatore deve essere ruotata da una posizione all'altra.
Built-in bath/shower mixer with 2-way diverter with ceramic head valve, on rectangular plate, horizontal mounting. To select the desired output, the diverter knob must be turned from one position to the other.

L92

Miscelatore monocomando a incasso per doccia, con deviatore a due posizioni (due uscite ed una entrata) su piastra unica.
Single-lever built-in shower mixer with 2 positions diverter (2 outlets and 1 inlet) on single plate.

CR FIN 1

CR FIN 1

N09HRB

Solo parte interna.
Built-in components only.



L09GE

Solo parte esterna.
Exposed components only.

CR FIN 1 CR FIN 1



2 VIE WAYS



2 VIE WAYS

SOLO PARTE ESTERNA - EXPOSED COMPONENTS ONLY:

L92ZWB

Miscelatore a incasso per vasca/doccia con deviatore a 2 vie di tipo meccanico, su piastra rettangolare.
Built-in bath/shower mixer with 2-way mechanical diverter, on rectangular plate.

CR FIN 1

SOLO PARTE ESTERNA - EXPOSED COMPONENTS ONLY:

L92ZPWB

Miscelatore a incasso per vasca/doccia con deviatore a 2 vie di tipo meccanico, su due piastre tonde.
Built-in bath/shower mixer with 2-way mechanical diverter, on two round plates.

CR FIN 1

SOLO PARTE INTERNA - BUILT-IN COMPONENTS ONLY:

WBOX92Z

pag 300

SOLO PARTE INTERNA - BUILT-IN COMPONENTS ONLY:

WBOX92Z

pag 300



2 VIE WAYS



SOLO PARTE ESTERNA - EXPOSED COMPONENTS ONLY:

L97D2PWB

Set miscelatore a incasso a 2 vie per vasca/doccia su 3 piastre tonde. Da completare con la seconda uscita.
2-way built-in shower mixer set on 3 round plates. To be completed with the second water outlet.

CR FIN 1



SOLO PARTE ESTERNA - EXPOSED COMPONENTS ONLY:

L97D2WB

Set miscelatore a incasso a 2 vie per vasca/doccia su piastra rettangolare. Da completare con la seconda uscita.
2-way built-in shower mixer set on rectangular plate. To be completed with the second water outlet.

CR FIN 1

SOLO PARTE INTERNA - BUILT-IN COMPONENTS ONLY:

WBOX97D2

pag 304

SOLO PARTE INTERNA - BUILT-IN COMPONENTS ONLY:

WBOX97D2

pag 304

3 VIE
WAYS



SOLO PARTE ESTERNA - EXPOSED COMPONENTS ONLY:

L93ZWB

Miscelatore a incasso per vasca/doccia con deviatore a 3 vie di tipo meccanico, su piastra rettangolare.
Built-in bath/shower mixer with 3-way mechanical diverter, on rectangular plate.

CR

FIN 1



SOLO PARTE ESTERNA - EXPOSED COMPONENTS ONLY:

L93ZPWB

Miscelatore a incasso per vasca/doccia con deviatore a 3 vie di tipo meccanico, su due piastre tonde.
Built-in bath/shower mixer with 3-way mechanical diverter, on two round plates.

CR

FIN 1

SOLO PARTE INTERNA - BUILT-IN COMPONENTS ONLY:

WBOX93Z

pag 302

SOLO PARTE INTERNA - BUILT-IN COMPONENTS ONLY:

WBOX93Z

pag 302



3 VIE
WAYS



SOLO PARTE ESTERNA - EXPOSED COMPONENTS ONLY:

L97D3PWB

Set miscelatore a incasso a 3 vie per vasca/doccia su 3 piastre tonde. Da completare con la seconda e la terza uscita acqua.
3-way built-in bath/shower mixer set on 3 round plates. To be completed with the second and the third water outlet.

CR

FIN 1



SOLO PARTE ESTERNA - EXPOSED COMPONENTS ONLY:

L97D3WB

Set miscelatore a incasso a 3 vie per vasca/doccia su piastra rettangolare. Da completare con la seconda e la terza uscita acqua.
3-way built-in shower mixer set on rectangular plate. To be completed with the second and the third water outlet.

CR

FIN 1

SOLO PARTE INTERNA - BUILT-IN COMPONENTS ONLY:

WBOX97D3

pag 308

SOLO PARTE INTERNA - BUILT-IN COMPONENTS ONLY:

WBOX97D3

pag 308



3 VIE
WAYS



L93

Miscelatore monocomando per doccia con deviatore a tre vie (una entrata e tre uscite) su unica piastra.
Single lever built-in shower mixer with three ways diverter (1 inlet and 3 outlets) on single plate.

CR

FIN 1



L94

Miscelatore monocomando per doccia, con deviatore a 4 posizioni (4 uscite ed 1 entrata) su piastra unica.

Single-lever shower mixer with 4 positions diverter (4 outlets and 1 inlet,) on single plate.

CR

FIN 1



L95

Miscelatore monocomando per doccia, con deviatore a 5 posizioni (5 uscite ed una entrata) su piastra unica.

Single-lever shower mixer with 5 positions diverter (5 outlets and 1 inlet) on single plate.

CR

FIN 1

SALISCENDI E COLONNE DOCCIA - SLIDING RAILS AND SHOWER COLUMNS

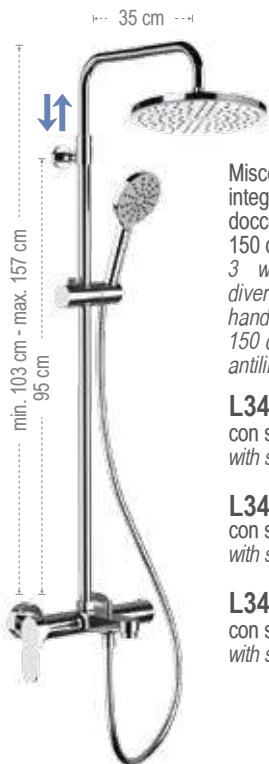

min. 103 cm - max. 157 cm
95 cm

Miscelatore vasca/doccia a 3 vie con deviatore integrato, colonna doccia telescopica (329A), doccetta in ABS anticalcare 3 funzioni, flessibile 150 cm e soffione in ABS con getti anticalcare.

3 ways bath/shower mixer with integrated diverter, telescopic shower column (329A), ABS handshower with antilimestone jets 3 functions, 150 cm flexible hose and ABS shower head, with antilimestone jets.

L34A8MPMD20

con soffione Ø 20 cm.
with shower head Ø 20 cm.

CR

L34A8MPMD25

con soffione Ø 25 cm.
with shower head Ø 25 cm.

CR

L34A8MPMD30

con soffione Ø 30 cm.
with shower head Ø 30 cm.

CR

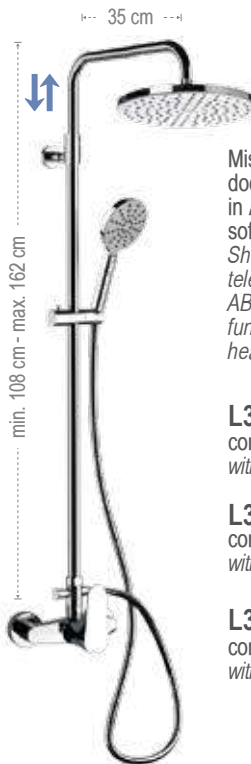

min. 108 cm - max. 162 cm

Miscelatore doccia con attacco da 3/4", colonna doccia telescopica con deviatore (330A), doccetta in ABS anticalcare 3 funzioni, flessibile 150 cm e soffione ABS con getti anticalcare.

Shower mixer with upper 3/4" connection, telescopic shower column with diverter (330A), ABS handshower with antilimestone jets 3 functions, 150 cm flexible hose and ABS shower head with antilimestone jets.

L37A8MPMD20

con soffione Ø 20 cm.
with shower head Ø 20 cm.

CR

L37A8MPMD25

con soffione Ø 25 cm.
with shower head Ø 25 cm.

CR

L37A8MPMD30

con soffione Ø 30 cm.
with shower head Ø 30 cm.

CR



METRICA
ENERGY / ECO
SLASH / DOT
ABSOLUTE
INFINITY
VANITY
DREAM
CLASS LINE
WINNER / ECO
LIBERTY

WINNER

ESTETICA E FUNZIONALITA'

AESTHETICS AND FUNCTIONALITY



Una linea semplice, progettata nei minimi dettagli per essere leggera ed estremamente funzionale in tutte le sue figure di bagno e cucina. Le sue forme essenziali si inseriscono con facilità in contesti moderni, mentre i suoi contorni discreti aggiungono un tocco di eleganza alle ambientazioni più classiche. La serie è dotata di cartuccia a dischi ceramici Ø 35 mm.

A simple line, designed up to the minimum detail to be lightweight and extremely functional in all its models for bathroom and kitchen. Its essential shapes easily fit in modern contexts, while its soft edges add a touch of elegance to the most traditional environments. The series is equipped with a Ø 35 mm ceramic disc cartridge.



WINNER



W11



W53D2PWB



W15NO



W11BO

//////////////////////////////////// OPZIONI DI FINITURA - FINISHING OPTIONS //////////////////////////////////////

CR		FIN 1		FIN 2	
	cromo chrome		nero opaco matt black		
	CR		bianco opaco matt white	NO	
			visual inox visual steel	BO	
				XV	

MISCELATORI LAVABO - WASHBASIN MIXERS



W10
 Miscelatore monocomando lavabo, con scarico.
Single-lever basin mixer, with pop-up waste.



W10P
 Miscelatore monocomando lavabo, con scarico in plastica.
Single-lever basin mixer, with plastic waste.



W11
 Miscelatore monocomando lavabo, senza scarico.
Single-lever basin mixer, without waste.



W10S
 Miscelatore monocomando lavabo, con scarico.
Single-lever basin mixer, with pop-up waste.



W10L
 Miscelatore monocomando lavabo alto L, con scarico click-clack con troppo-pieno.
Single-lever high L basin mixer, with click-clack waste and overflow.

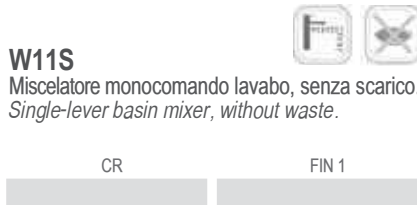

W11S
 Miscelatore monocomando lavabo, senza scarico.
Single-lever basin mixer, without waste.



W57
 Miscelatore monocomando lavabo due fori, senza scarico.
Two holes single-lever washbasin mixer, without waste.

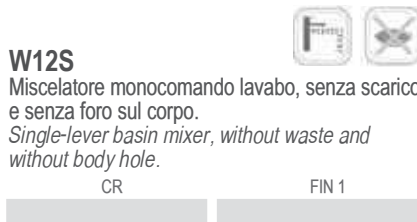

W12S
 Miscelatore monocomando lavabo, senza scarico e senza foro sul corpo.
Single-lever basin mixer, without waste and without body hole.

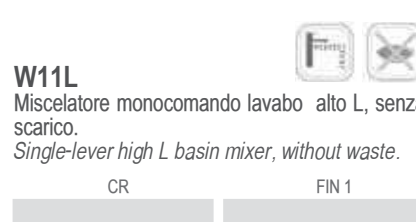

W11L
 Miscelatore monocomando lavabo alto L, senza scarico.
Single-lever high L basin mixer, without waste.

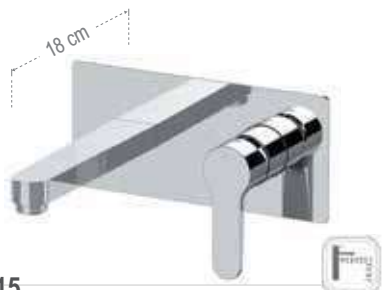

W15
 Miscelatore monocomando a incasso per lavabo, con piastra orizzontale in ottone.
Single-lever built-in basin mixer, with wall plate in brass.

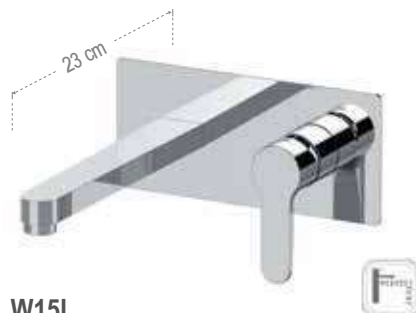

W15L
 Miscelatore monocomando a incasso per lavabo, con piastra orizzontale in ottone, lunghezza bocca 23 cm.
Single-lever built-in basin mixer, with wall plate in brass, spout length cm 23.



W72C
 Miscelatore monocomando lavabo senza scarico, con canna corta girevole a "U", tipo lusso.
Single-lever basin mixer without waste, with short swivel "U" spout, luxury type.



BOCCHIE - SPOUTS



W72
Miscelatore monocomando monoforo 90°, con canna alta girevole a "U".
Single-lever sink mixer 90°, high swivel "U" spout.

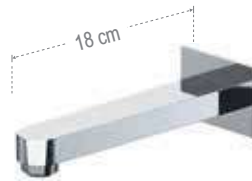

91L
Bocca incasso per miscelatore vasca/doccia.
Built-in spout for bath/shower mixer.

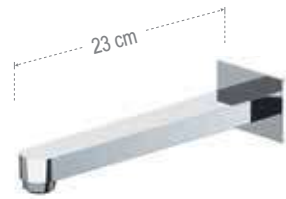

91LL
Bocca incasso per miscelatore vasca/doccia, lunghezza bocca 23 cm.
Built-in spout for bath/shower mixer, spout length cm 23.



91LD
Bocca incasso con deviatore integrato.
Built-in spout with diverter.



LAVABO A MURO CON BOX INCASSO - WALL WASHBASIN MIXER WITH BUILT-IN BOX

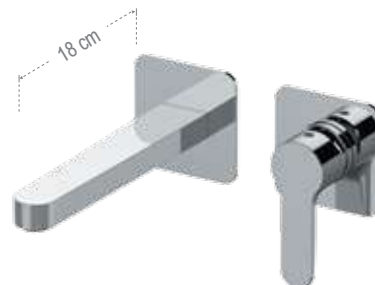
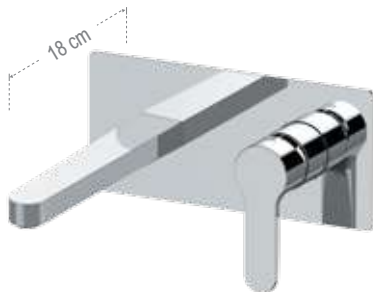

SOLO PARTE ESTERNA - EXPOSED COMPONENTS ONLY:

W15WB
Parti esterne per miscelatore monocomando a incasso per lavabo da abbinare al box incasso (non incluso). Piastra ultra-piatta. Lunghezza bocca 18 cm.
Exposed components for single-lever built-in basin mixer, with ultra-flat wall plate. To match with the built-in box (not included). Spout length 18 cm.



W15LWB
Idem sopra, con lunghezza bocca 23 cm.
Same as above, with spout length 23 cm.



SOLO PARTE ESTERNA - EXPOSED COMPONENTS ONLY:

W15PWB
Parti esterne per miscelatore monocomando a incasso per lavabo da abbinare al box incasso (non incluso). Su due piastre quadrate separate. Lunghezza bocca 18 cm.
Exposed components for single-lever built-in basin mixer, with two separate square plates. To match with the built-in box (not included). Spout length 18 cm.



W15PLWB
Idem sopra, con lunghezza bocca 23 cm.
Same as above, with spout length 23 cm.



SOLO PARTE INTERNA - BUILT-IN COMPONENTS ONLY:

WBOX15

SOLO PARTE INTERNA - BUILT-IN COMPONENTS ONLY:

WBOX15

MISCELATORI BIDET - BIDET MIXERS



W20
 Miscelatore monocomando bidet, con scarico.
Single-lever bidet mixer, with pop-up waste.



W20P
 Miscelatore monocomando bidet, con scarico in plastica.
Single-lever bidet mixer, with plastic waste.

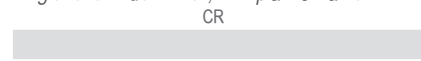

W22
 Miscelatore monocomando per bidet, senza scarico e senza foro posteriore sul corpo.
Single-lever bidet mixer, without waste and without rear body hole.



W65W
 Miscelatore incasso per shut-off con supporto doccia/presa acqua integrato, attacco conico da 1/2", tutto in ottone, con doccetta shut-off e flessibile cm 120.
Built-in shower mixer with integrated shower holder/water punch on flange all in brass, with 1/2 connection, including shut-off and flexible hose cm 120.



WC31DP
 Miscelatore monocomando esterno doccia, interasse 100 mm, con doccetta shut-off e flessibile cm 120.
Wall mounted single lever shower mixer, interaxis 100 mm, including shut-off and flexible hose cm 120.



W65B
 Miscelatore incasso per shut-off con supporto doccia/presa acqua integrato, attacco conico da 1/2", tutto in ottone, senza kit doccia.
Built-in shower mixer with integrated shower holder/water punch on flange all in brass, with 1/2 connection, without shower kit.



WC31
 Miscelatore monocomando esterno doccia, interasse 100 mm, senza kit doccia.
Wall mounted single lever shower mixer, interaxis 100 mm, without shower kit.



W02
 Miscelatore vasca con deviatore integrato, con flessibile cm 150 e doccetta a 4 funzioni con getti in silicone anticalcare e supporto snodato.
Wall mounted bath mixer with integrated diverter, with flexible cm 150 and 4 functions antilimestone handshower with silicon jets and swivel shower holder.



W05
 Miscelatore vasca con deviatore integrato, senza kit doccia.
Wall mounted bath mixer with integrated diverter, without shower kit.



MISCELATORI ESTERNI PER VASCA E DOCCIA - EXPOSED MIXERS FOR BATH AND SHOWER



W03

Miscelatore monocomando per vasca, con flessibile cm 150 e doccetta a 4 funzioni, getti in silicone anticalcare e supporto snodato.
Single lever bath mixer with diverter, with flexible cm 150 and 4 functions antilimestone handshower with silicon jets and swivel shower holder.

CR



W49

Miscelatore lavabo/vasca con canna fusa lunghezza 30 cm con deviatore integrato, con flessibile cm 150 e doccetta a 4 funzioni con getti in silicone anticalcare e supporto snodato.
Wall mounted basin/bath single lever mixer with long casted spout length 30 cm and integrated diverter, with flexible cm 150 and 4 functions antilimestone handshower with silicon jets and swivel shower holder.

CR



W39

Miscelatore doccia, con flessibile cm 150 e doccetta a 4 funzioni con getti in silicone anticalcare e supporto snodato.
Exposed shower mixer, with flexible cm 150 and 4 functions antilimestone handshower with silicon jets and swivel shower holder.

CR



W04

Miscelatore monocomando per vasca, senza kit doccia.
Single lever bath mixer with diverter, without shower kit.

CR

FIN 1

W46

Miscelatore lavabo/vasca con canna fusa lunghezza 30 cm con deviatore integrato, senza kit doccia.
Wall mounted basin/bath single lever mixer with long casted spout length 30 cm and integrated diverter, without shower kit.

CR

FIN 1

W31

Miscelatore doccia, senza kit doccia.
Exposed shower mixer, without shower kit.

CR

FIN 1



W38

Miscelatore doccia con leva frontale, con flessibile cm 150 e doccetta a 4 funzioni con getti in silicone anticalcare e supporto snodato.
Exposed shower mixer with frontal lever, with flexible cm 150 and 4 functions antilimestone handshower with silicon jets and swivel shower holder.

CR



W07UF

Miscelatore monocomando bordo vasca con deviatore integrato nel miscelatore, bocca a cascata e doccetta estribile in ABS cromato a 4 funzioni, flessibile 150 cm.
Single lever deck bath mixer with diverter integrated on the mixer, with waterfall spout and pull-out 4 functions chrome plated ABS handshower, flexible hose 150 cm.

CR



W07

Miscelatore monocomando bordo vasca con deviatore a leva integrato nella bocca minimale e doccetta estribile in ABS cromato a 4 funzioni, flessibile 150 cm.
Single lever deck bath mixer with lever diverter integrated on the spout, with minimal spout and pull-out 4 functions chrome plated ABS handshower, flexible hose 150 cm.

CR



W33

Miscelatore doccia con leva frontale, senza kit doccia.
Exposed shower mixer with frontal lever, without shower kit.

CR

FIN 1

MISCELATORI A INCASSO PER VASCA - BUILT-IN MIXERS FOR BATH



2 VIE WAYS



SOLO PARTE ESTERNA - EXPOSED COMPONENTS ONLY:

W53D2WB

Set a incasso a 2 vie per vasca su piastra unica rettangolare.
2-way built-in set for bathtub on a single rectangular plate

CR

FIN 1



SOLO PARTE ESTERNA - EXPOSED COMPONENTS ONLY:

W53D2PWB

Set a incasso a 2 vie per vasca su piastre tonde separate.
2-way built-in set for bathtub on separate round plates.

CR

FIN 1

SOLO PARTE INTERNA - BUILT-IN COMPONENTS ONLY:

WBOX97D2

pag 304

SOLO PARTE INTERNA - BUILT-IN COMPONENTS ONLY:

WBOX97D2

pag 304



2 VIE WAYS



SOLO PARTE ESTERNA - EXPOSED COMPONENTS ONLY:

W54D2WB

Set miscelatore a incasso a 2 vie per vasca/doccia su piastra unica rettangolare. Da completare con la seconda uscita.
2-way built-in mixer set for bathtub / shower on single rectangular plate. To be completed with the second water outlet.

CR

FIN 1



SOLO PARTE ESTERNA - EXPOSED COMPONENTS ONLY:

W54D2PWB

Set miscelatore a incasso a 2 vie per vasca/doccia su 3 piastre tonde. Da completare con la seconda uscita acqua.
2-way built-in mixer set for bathtub / shower on 3 round plates. To be completed with the second water outlet.

CR

FIN 1

SOLO PARTE INTERNA - BUILT-IN COMPONENTS ONLY:

WBOX97D2

pag 304

SOLO PARTE INTERNA - BUILT-IN COMPONENTS ONLY:

WBOX97D2

pag 304



3 VIE WAYS



SOLO PARTE ESTERNA - EXPOSED COMPONENTS ONLY:

W54D3WB

Set miscelatore a incasso a 3 vie per vasca/doccia su piastra unica rettangolare. Da completare con la seconda e la terza uscita acqua.
3-way built-in mixer set for bathtub / shower on single rectangular plate. To be completed with the second and the third water outlet.

CR

FIN 1



SOLO PARTE ESTERNA - EXPOSED COMPONENTS ONLY:

W54D3PWB

Set miscelatore a incasso a 3 vie per vasca/doccia su 3 piastre tonde. Da completare con la seconda e la terza uscita acqua.
3-way built-in mixer set for bathtub / shower on 3 separate round plates. To be completed with the second and the third water outlet.

CR

FIN 1

SOLO PARTE INTERNA - BUILT-IN COMPONENTS ONLY:

WBOX97D3

pag 308

SOLO PARTE INTERNA - BUILT-IN COMPONENTS ONLY:

WBOX97D3

pag 308

Set doccia acquistabile separatamente a pagina 427 - Shower set can be purchased separately on page 427

MISCELATORI A INCASSO PER DOCCIA - BUILT-IN MIXERS FOR SHOWER

1 VIA WAY



W30
Miscelatore monocomando a incasso per doccia completo.
Complete built-in shower single lever mixer.

CR

FIN 1

2 VIE WAYS



W09
Miscelatore monocomando a incasso con deviatore per vasca/doccia completo.
Complete built-in bath/shower single-lever mixer with diverter.

CR

FIN 1



N09B

Solo parte interna.
Built-in components only.



CR

FIN 1

W09E

Solo parte esterna.
Exposed components only.

CR

FIN 1

2 VIE WAYS

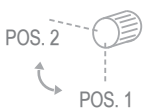

W09H
Miscelatore a incasso per vasca/doccia con deviatore a 2 vie a vitone ceramico, su piastra tonda. Per selezionare l'uscita desiderata, la manopola del deviatore deve essere ruotata da una posizione all'altra.
Built-in bath/shower mixer with 2-way diverter with ceramic head valve, on round wall plate. To select the desired output, the diverter knob must be turned from one position to the other.

CR

FIN 1



W09HRG
Miscelatore a incasso per vasca/doccia con deviatore a 2 vie con vitone ceramico, su piastra rettangolare, montaggio orizzontale. Per selezionare l'uscita desiderata, la manopola del deviatore deve essere ruotata da una posizione all'altra.
Built-in bath/shower mixer with 2-way diverter with ceramic head valve, on rectangular plate, horizontal mounting. To select the desired output, the diverter knob must be turned from one position to the other.

CR

FIN 1



N09HB

Solo parte interna.
Built-in components only.



CR

FIN 1

W09E

Solo parte esterna.
Exposed components only.

CR

FIN 1

N09HRB

Solo parte interna.
Built-in components only.



CR

FIN 1

W09GE

Solo parte esterna.
Exposed components only.

CR

FIN 1

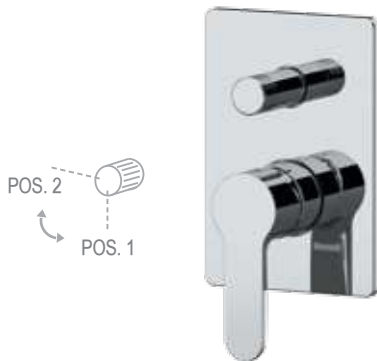

W09HG

Miscelatore a incasso per vasca/doccia con deviatore a 2 vie a vitone ceramico, su piastra rettangolare. Per selezionare l'uscita desiderata, la manopola del deviatore deve essere ruotata da una posizione all'altra.
Built-in bath/shower mixer with 2-way diverter with ceramic head valve, on rectangular wall plate. To select the desired output, the diverter knob must be turned from one position to the other.



W92

Miscelatore monocomando a incasso per doccia, con deviatore a due posizioni (due uscite ed una entrata) su piastra unica.
Single-lever built-in shower mixer with 2 positions diverter (2 outlets and 1 inlet) on single plate.



N09HB

Solo parte interna.
Built-in components only.



W09GE

Solo parte esterna.
Exposed components only.



SOLO PARTE ESTERNA - EXPOSED COMPONENTS ONLY:

W92ZWB

Miscelatore a incasso per vasca/doccia con deviatore a 2 vie di tipo meccanico, su piastra rettangolare.
Built-in bath/shower mixer with 2-way mechanical diverter, on rectangular plate.



SOLO PARTE ESTERNA - EXPOSED COMPONENTS ONLY:

W92ZPWB

Miscelatore a incasso per vasca/doccia con deviatore a 2 vie di tipo meccanico, su due piastre tonde.
Built-in bath/shower mixer with 2-way mechanical diverter, on two round plates.



SOLO PARTE INTERNA - BUILT-IN COMPONENTS ONLY:

WBOX92Z

pag 300

SOLO PARTE INTERNA - BUILT-IN COMPONENTS ONLY:

WBOX92Z

pag 300

2 VIE
WAYS



SOLO PARTE ESTERNA - EXPOSED COMPONENTS ONLY:

W97D2PWB

Set miscelatore a incasso a 2 vie per vasca/doccia su 3 piastre tonde. Da completare con la seconda uscita.
2-way built-in shower mixer set on 3 round plates. To be completed with the second water outlet.

CR

FIN 1



SOLO PARTE ESTERNA - EXPOSED COMPONENTS ONLY:

W97D2WB

Set miscelatore a incasso a 2 vie per vasca/doccia su piastra rettangolare. Da completare con la seconda uscita.
2-way built-in shower mixer set on rectangular plate. To be completed with the second water outlet.

CR

FIN 1

SOLO PARTE INTERNA - BUILT-IN COMPONENTS ONLY:

WBOX97D2

> pag 304

SOLO PARTE INTERNA - BUILT-IN COMPONENTS ONLY:

WBOX97D2

> pag 304

3 VIE
WAYS

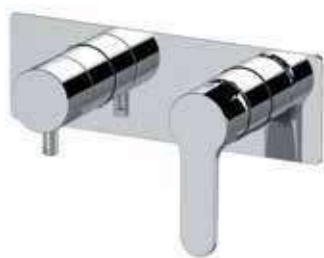

SOLO PARTE ESTERNA - EXPOSED COMPONENTS ONLY:

W93ZWB

Miscelatore a incasso per vasca/doccia con deviatore a 3 vie di tipo meccanico, su piastra rettangolare.
Built-in bath/shower mixer with 3-way mechanical diverter, on rectangular plate.

CR

FIN 1



SOLO PARTE ESTERNA - EXPOSED COMPONENTS ONLY:

W93ZPWB

Miscelatore a incasso per vasca/doccia con deviatore a 3 vie di tipo meccanico, su due piastre tonde.
Built-in bath/shower mixer with 3-way mechanical diverter, on two round plates.

CR

FIN 1

SOLO PARTE INTERNA - BUILT-IN COMPONENTS ONLY:

WBOX93Z

> pag 302

SOLO PARTE INTERNA - BUILT-IN COMPONENTS ONLY:

WBOX93Z

> pag 302

3 VIE
WAYS



SOLO PARTE ESTERNA - EXPOSED COMPONENTS ONLY:

W97D3PWB

Set miscelatore a incasso a 3 vie per vasca/doccia su 3 piastre tonde. Da completare con la seconda e la terza uscita acqua.
3-way built-in bath/shower mixer set on 3 round plates. To be completed with the second and the third water outlet.

CR

FIN 1



SOLO PARTE ESTERNA - EXPOSED COMPONENTS ONLY:

W97D3WB

Set miscelatore a incasso a 3 vie per vasca/doccia su piastra rettangolare. Da completare con la seconda e la terza uscita acqua.
3-way built-in shower mixer set on rectangular plate. To be completed with the second and the third water outlet.

CR

FIN 1

SOLO PARTE INTERNA - BUILT-IN COMPONENTS ONLY:

WBOX97D3

pag 308

SOLO PARTE INTERNA - BUILT-IN COMPONENTS ONLY:

WBOX97D3

pag 308



W93

Miscelatore monocomando per doccia con deviatore a tre vie (una entrata e tre uscite) su unica piastra.
Single lever built-in shower mixer with three ways diverter (1 inlet and 3 outlets) on single plate.

CR

FIN 1

SALISCENDI E COLONNE DOCCIA - SLIDING RAILS AND SHOWER COLUMNS

METRICA

ENERGY / ECO

SLASH / DOT

ABSOLUTE

INFINITY

VANITY

DREAM

CLASS LINE

WINNER / ECO

LIBERTY



W37AEC20

Set doccia composto da: miscelatore esterno con attacco superiore, soffione in abs Ø 20cm 354EC20X, colonna doccia in ottone telescopica, altezza asta regolabile, con deviatore 330A, doccetta in abs a 4 funzioni 319MO, flessibile 150 cm.

Shower set including: exposed mixer with upper connection, abs Ø 20 cm shower head 354EC20X, telescopic brass shower column, with height-adjustable rod, with diverter 330A, 4-function abs hand shower 319MO, 150 cm flexible hose.

CR

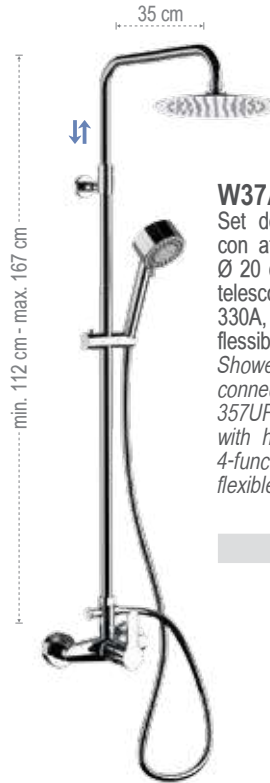

W37AUFM20

Set doccia composto da: miscelatore esterno con attacco superiore, soffione in acciaio inox Ø 20 cm 357UFM20X, colonna doccia in ottone telescopica, altezza asta regolabile, con deviatore 330A, doccetta in abs a 4 funzioni 319MO, flessibile 150 cm.

Shower set including: exposed mixer with upper connection, stainless steel Ø 20cm shower head 357UFM20X, telescopic brass shower column, with height-adjustable rod, with diverter 330A, 4-function abs hand shower 319MO, 150 cm flexible hose.

CR

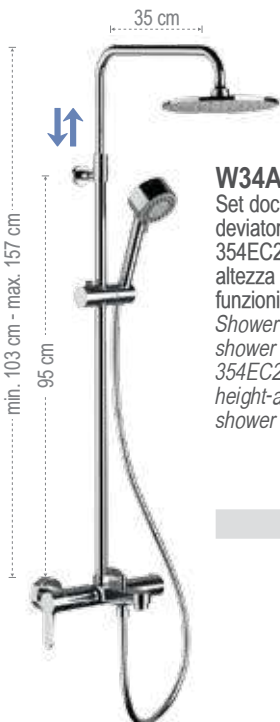

W34AEC20

Set doccia composto da: miscelatore esterno con deviatore vasca/doccia, soffione in abs Ø 20cm 354EC20X, colonna doccia in ottone telescopica, altezza asta regolabile 329A, doccetta in abs a 4 funzioni 319MO, flessibile 150 cm.

Shower set including: exposed mixer with bath/shower diverter, abs Ø 20 cm shower head 354EC20X, telescopic brass shower column, with height-adjustable rod 329A, 4-function abs hand shower 319MO, 150 cm flexible hose.

CR



W34AUFM20

Set doccia composto da: miscelatore esterno con deviatore vasca/doccia, soffione in acciaio inox Ø 20 cm 357UFM20X, colonna doccia in ottone telescopica, altezza asta regolabile 329A, doccetta in abs a 4 funzioni 319MO, flessibile 150 cm.

Shower set including: exposed mixer with bath/shower diverter, stainless steel Ø 20cm shower head 357UFM20X, telescopic brass shower column, with height-adjustable rod 329A, 4-function abs hand shower 319MO, 150 cm flexible hose.

CR



WINNER | SET

COMPOSIZIONE DEL BOX - BOX COMPOSITION:

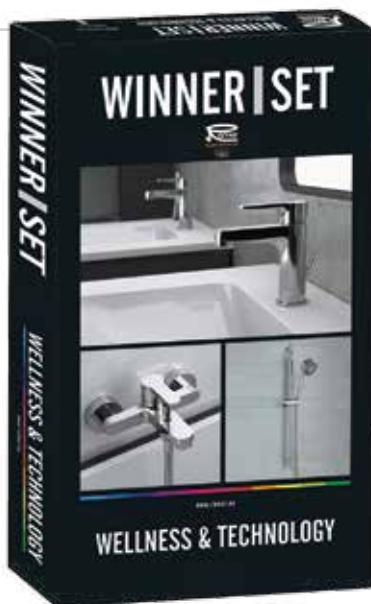

W0510315RMOI

Set composto da: miscelatore vasca esterno W05, saliscendi tondo 315R, miscelatore per lavabo con scarico W10, doccia in abs a 4 funzioni 319MO, flessibile 150 cm.

Set including: Exposed bath mixer W05, round sliding rail 315R, basin mixer with pop-up waste W10, 4-function abs hand shower 319MO, 150 cm flexible hose.

CR



COMPOSIZIONE DEL BOX - BOX COMPOSITION:

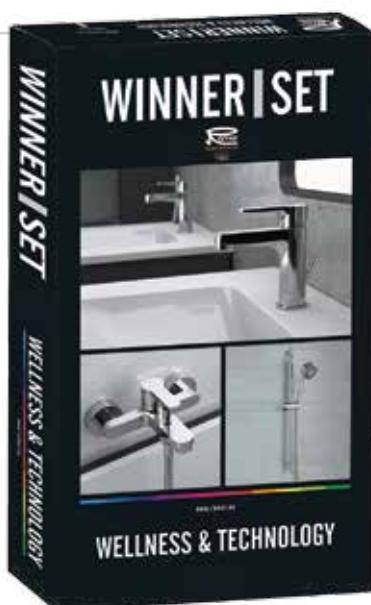

W0910315RMOI

Set composto da: miscelatore a incasso con deviatore, soffione in abs Ø 20cm 354EC20X, braccio in ottone 30 cm, saliscendi tondo 315R, miscelatore per lavabo con scarico W10, presa acqua a muro, doccia in abs a 4 funzioni 319MO, flessibile 150 cm.

Set including: built-in mixer with diverter, abs Ø 20 cm shower head 354EC20X, brass arm 30 cm, round sliding rail 315R, basin mixer with pop-up waste W10, wall water connection, 4-function abs hand shower 319MO, 150 cm flexible hose..

CR



COMPOSIZIONE DEL BOX - BOX COMPOSITION:

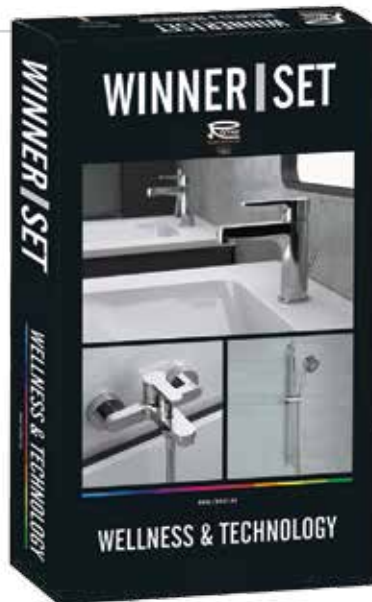

W051020315RMOI

Set composto da: miscelatore vasca esterno W05, saliscendi tondo 315R, miscelatore per lavabo con scarico W10, miscelatore bidet con scarico (W20), doccia in abs a 4 funzioni 319MO, flessibile 150 cm.

Set including: Exposed bath mixer W05, round sliding rail 315R, basin mixer with pop-up waste W10, bidet mixer with pop-up waste (W20); 4-function abs hand shower 319MO, 150 cm flexible hose.

CR



W05

WINNER ECO 

WINNER ECO



WINNER ECO è una collezione monocomando dal design moderno e giovanile, creata per controllare e ridurre i consumi idrici ed energetici in casa. La combinazione di più tecnologie di risparmio permette infatti di limitare alla sola necessità sia il consumo di acqua che l'utilizzo di acqua calda, senza stravolgere le abitudini quotidiane. La serie è dotata di cartuccia ENERGY SAVING a dischi ceramici Ø 35 mm.

WINNER ECO is a single-lever collection with a modern and youthful design, created to control and reduce water and energy consumption in the home. The combination of different saving technologies limit to the actual need both the consumption of water and the use of hot water, without upsetting daily habits. The series is equipped with a Ø 35 mm ceramic disc ENERGY SAVING cartridge.



WE12LT6



ACQUA E AMBIENTE
WATER & ENVIRONMENT
WATER SAVING

PROGRAMMA ECO

ECO PROGRAM



Design e tecnologia ambientale

Design and environmental technology

Il programma ECO nasce per il controllo dei consumi, per un reale risparmio sia economico che ambientale. WINNER ECO combina diverse tecnologie di risparmio: cartuccia ENERGY SAVING, aeratore WATER SAVING, anello ANTISCALDING, leva WATER SAVING DYNAMIC.

Funzioni standard incluse:

La cartuccia **ENERGY SAVING** di serie evita la richiesta accidentale e involontaria di acqua calda, consentendo un risparmio energetico.

Questa funzione prevede l'apertura in sola acqua fredda quando la leva è allineata alla bocca del miscelatore; per l'erogazione di acqua calda è invece necessario un movimento volontario della leva verso sinistra.

Aeratore **WATER SAVING** di serie. I miscelatori WINNER ECO sono dotati di serie di un aeratore con limitazione di portata di 6 litri al minuto (disponibile anche nelle varianti da 8, 4, 3 L / min).

Per ottimizzare il risparmio, la collezione WINNER ECO può essere integrata, su richiesta, anche con le seguenti **tecnologie opzionali**:

Tecnologia **ANTISCALDING** per limitare la temperatura massima dell'acqua erogabile. Questa tecnologia applica una speciale ghiera sulla cartuccia che permette, previa regolazione durante l'installazione, la limitazione della temperatura massima erogabile, impedendo la completa rotazione della maniglia verso l'acqua calda.

Tecnologia **WATER SAVING DYNAMIC**: un promemoria per utilizzare solo la quantità di acqua strettamente necessaria ad ogni operazione. Questo sistema permette di percepire una leggera limitazione all'apertura della leva intorno al 50% dell'erogazione massima d'acqua del miscelatore: un invito per l'utente a non aprire completamente il flusso dell'acqua quando non strettamente necessario. Superando questa leggera resistenza, l'erogazione del flusso al 100% della portata rimane sempre possibile e con la solita morbidezza della leva.

ECO program is created to control consumption for effective economic and environmental savings. WINNER ECO combines different saving technologies: ENERGY SAVING cartridge, WATER SAVING aerator, ANTISCALDING ring, WATER SAVING DYNAMIC lever.

Standard features included:

ENERGY SAVING cartridge as standard equipment avoids the accidental and unintentional request of hot water, thus allowing energy savings.

This function provides for opening in only cold water when the lever is aligned with the mixer spout; for the supply of hot water a voluntary movement of the lever to the left is instead necessary.

WATER SAVING aerator: WINNER ECO mixers are standard equipped with a low flow aerator with a limitation of 6 liters per minute (also available in 8, 4, 3 L / min variants).

To optimize savings, WINNER ECO collection can also be easily integrated, on demand, with the following optional technologies:

ANTISCALDING ring technology to limit the maximum temperature of the water supplied. This technology applies a special ring nut on the cartridge that allows, after adjustment during installation, the limitation of the maximum deliverable temperature, preventing the complete rotation of the lever towards hot water.

WATER SAVING DYNAMIC technology: a reminder to use only the amount of water strictly necessary for each operation.

During the opening phase this system provides a slight limitation of the lever around the 50% of the maximum water supply: an invitation for the user not to fully open the water flow when not strictly necessary. By overcoming this slight resistance, the delivery of the flow at 100% of the flow is always possible and with the usual softness of the lever.

STANDARD ECO



ENERGY SAVING :

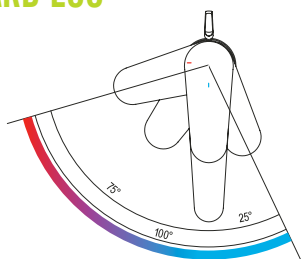

WATER SAVING :



OPTIONS:

3 L/MIN
4 L/MIN
8 L/MIN

COD. 83L6
STANDARD 6 L/min

OPTIONAL ECO



ANTISCALDING :



WATER SAVING
DYNAMIC :

FULL FLOW 2
WATER SAVING 1
CLOSE 0

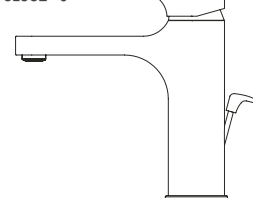



WE11LT6

La serie Eco viene proposta in una gamma di articoli in cui la tecnologia Eco trova migliori benefici nell'uso.

Gli articoli doccia e vasca non sono stati proposti in quanto si presuppone che non vi sia la necessità di apertura in acqua fredda in quanto gli ambienti vasca e doccia sono generalmente utilizzati per loro natura con acqua miscelata/calda. Per completare la gamma Eco con gli articoli vasca/doccia si consiglia di utilizzare la serie nella versione cartuccia standard.

Le versioni eco vasca e doccia sono comunque disponibili a richiesta.

The Eco series covers a range of items in which the Eco technology finds best benefit of use.

The shower and bathtub items are not offered because it is assumed that there is no need to open in cold water as the bathtub and shower environments are generally used with mixed/hot water for their nature.

To complete the Eco range with bath/shower items, we suggest to use the series in standard cartridge version.

The bath and shower eco versions are anyway available on demand.

WINNER ECO



FLESSIBILI MADE IN ITALY,
IN GOMMA ALIMENTARE EPDM,
RACCORDATI CON MACCHINE
AUTOMATICHE
MADE IN ITALY FLEXIBLE HOSES,
WITH EPDM ALIMENTARY RUBBER,
MADE BY AUTOMATIC
ASSEMBLING MACHINES



CARTUCCIA MADE IN ITALY
TECNOLOGICA REALIZZATA
CON PLASTICA ALIMENTARE
ECO FRIENDLY
MADE IN ITALY ECO FRIENDLY
TECHNOLOGIC CARTRIDGE

AERATORE A
RISPARMIO IDRICO
WATER SAVING
AERATOR

LAVABI ECO - ECO WASHBASIN MIXERS 

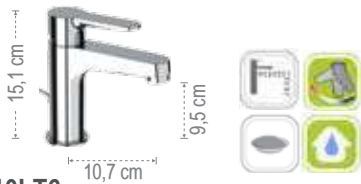

WE10LT6
Miscelatore monocomando lavabo, con scarico.
Single-lever basin mixer, with pop-up waste.

CR



WE11LT6
Miscelatore monocomando lavabo, senza scarico.
Single-lever basin mixer, without waste.

CR



WE12LT6
Miscelatore monocomando lavabo, senza scarico e senza foro sul corpo.
Single-lever basin mixer, without waste and without body hole.

CR



WE10LLT6
Miscelatore monocomando lavabo alto L, con click-clack con troppo pieno.
Single-lever L high basin mixer, with click-clack waste with overflow.

CR



WE72CLT6
Miscelatore monocomando lavabo senza scarico, con canna corta girevole a "U", tipo lusso.
Single-lever basin mixer without waste, with short swivel "U" spout, luxury type.

CR



WE15LT6
Miscelatore monocomando a incasso per lavabo, con piastra rettangolare in ottone.
Single-lever built-in basin mixer, with rectangular wall plate in brass.

CR

WE11LLT6
Miscelatore monocomando lavabo alto L, senza scarico.
Single-lever L high basin mixer, without waste.

CR

BIDET ECO - ECO BIDET MIXERS 



WE20LT6
Miscelatore monocomando bidet, con scarico.
Single-lever bidet mixer, with pop-up waste.

CR

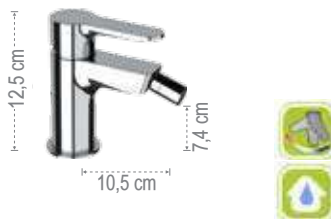

WE22LT6
Miscelatore monocomando per bidet, senza scarico e senza foro posteriore sul corpo.
Single-lever bidet mixer, without waste and without rear body hole.

CR



WE65LT6
Miscelatore incasso per shut-off comprensivo di: doccetta shut-off, supporto doccia-presa acqua su piastra in ottone e flessibile doccia cm 120.
Built-in shower mixer set including :shut-off, shower holder-water punch on flange, all in brass and shower flexible cm 120.

CR

SOFFIONI - SHOWER HEADS



351AXLT8

Soffione con disco anticalcare a snodo \varnothing 7 cm con limitatore di portata a 8 litri/minuto, con scatola.
Shower-head with anti-limestone jet \varnothing 7 cm with balljoint with 8 liters/minute flow limiter, box included.

CR



354EC20XLT8

Soffione a pioggia minimale, in abs cromato \varnothing 20 cm, con getti in silicone anticalcare con limitatore di portata a 8 litri/minuto, con scatola.
c.p. abs shower head, rain jet \varnothing 20 cm, with anti-limestone silicon jets with 8 liters/minute flow limiter, box included..

CR



357UFS25XLT8

Soffione doccia ultra piatto in acciaio inox lucidato a specchio 25x25cm, con limitatore di portata a 8 litri/minuto, con scatola.
Ultra slim stainless steel mirror polished shower head 25x25 cm, with 8 liters/minute flow limiter, box included.

CR



357UFM25XLT8

Soffione doccia ultra piatto in acciaio inox lucidato a specchio \varnothing 25 cm, con limitatore di portata a 8 litri/minuto, con scatola.
Ultra slim stainless steel mirror polished shower head \varnothing 25 cm, with 8 liters/minute flow limiter, box included.

CR

CUCINA ECO - ECO KITCHEN MIXERS



WE72LT6

Miscelatore monocomando monoforo 90°, con canna alta girevole a "U".
Single-lever sink mixer 90°, high swivel "U" spout.

CR



WE42LT6

Miscelatore monocomando per lavello, con bocca alta girevole.
Single-lever one-hole sink mixer, with high swivel spout.

CR



WE42CLT6

Miscelatore monocomando per lavello, canna corta girevole, tipo lusso.
Single-lever one-hole sink mixer, shorter swivel spout, luxury type.

CR



WE42RLT6

Miscelatore monocomando monoforo 90° per lavello, con bocca alta girevole ed abbattibile, tipo lusso, modello sottofinestra.
Single-lever one-hole sink mixer, with swivel and foldable high spout, luxury type, under window type.

CR



WE41LT6

Miscelatore monocomando per lavello a muro con canna girevole 20 cm.
Single-lever wall mounted sink mixer with swivel spout length 20 cm.

CR

LIBERTY

LE FORME SINUOSE ED ELEGANTI DELL'ART NOUVEAU
THE SINUOUS AND ELEGANT SHAPES OF ART NOUVEAU



La serie può essere dotata di vitoni tradizionali oppure di vitoni ceramici. Selezionare la preferenza al momento dell'ordine.

The series can be equipped with traditional headvalves or ceramic headvalves. Select your preference before ordering.





13ALIDO



LIBERTY







09LIB20VO



13ALIDO

//////////////////////////////////// OPZIONI DI FINITURA - FINISHING OPTIONS //////////////////////////////////////

CR		FIN 1		FIN 2	
	cromo chrome		vecchio ottone old brass		oro lucido shiny gold
	CR		vecchio rame old copper		DO
			VO		
			VR		

LIBERTY

VITONE CERAMICO - CERAMIC HEADVALVE



Disponibile anche con vitone ceramico; aggiungere "CE" alla fine del codice.
Available also with ceramic headvalve; add "CE" at the end of the article number.

SOLO MANIGLIA - ONLY LEVER



71LI
Maniglia.
Lever.

MISCELATORI LAVABO - WASHBASIN MIXERS



Batteria lavabo/lavello da incasso senza scarico.
Concealed 2-handle basin/sink faucet without waste.

ART.	10LI	10LICE
FINITURA FINISHING	VITONE TRADIZIONALE TRADITIONAL HEAD VALVE	VITONE CERAMICO CERAMIC HEAD VALVE



Batteria lavabo con scarico automatico.
2-handle basin faucet set with pop-up waste.

ART.	11LI	11LICE
FINITURA FINISHING	VITONE TRADIZIONALE TRADITIONAL HEAD VALVE	VITONE CERAMICO CERAMIC HEAD VALVE



Batteria lavabo con bocca a "C" e scarico automatico.
Altezza bocca 9,5 cm, interasse 19 cm.
2-handle basin faucet set with "C" spout and pop-up waste. Height spout 9,5 cm, Interaxis 19 cm.

ART.	11CLI	11CLICE
FINITURA FINISHING	VITONE TRADIZIONALE TRADITIONAL HEAD VALVE	VITONE CERAMICO CERAMIC HEAD VALVE



Miscelatore tradizionale bicomando monoforo per lavabo, con canna fusa e scarico automatico.
Altezza 20 cm, interasse 17 cm.
One-hole traditional 2-handle basin faucet, with casted spout and pop-up waste. Height 20 cm, Interaxis 17 cm.

ART.	13CLI	13CLICE
FINITURA FINISHING	VITONE TRADIZIONALE TRADITIONAL HEAD VALVE	VITONE CERAMICO CERAMIC HEAD VALVE



Miscelatore tradizionale bicomando monoforo per lavabo, con canna alta e scarico automatico.
Altezza 26 cm, interasse 19 cm.
One-hole traditional 2-handle basin faucet, with high spout and pop-up waste. Height 26 cm, Interaxis 19 cm.

ART.	13GLI	13GLICE
FINITURA FINISHING	VITONE TRADIZIONALE TRADITIONAL HEAD VALVE	VITONE CERAMICO CERAMIC HEAD VALVE



Miscelatore tradizionale bicomando monoforo lavabo con scarico click-clack con troppo-pieno.
Altezza 17,5 cm, interasse 13 cm.
One-hole 2-handle basin faucet with click-clack waste with overflow. Height 17,5 cm, Interaxis 13 cm.

ART.	13LIB	13LIBCE
FINITURA FINISHING	VITONE TRADIZIONALE TRADITIONAL HEAD VALVE	VITONE CERAMICO CERAMIC HEAD VALVE



Miscelatore tradizionale bicomando monoforo lavabo con scarico automatico.
Altezza bocca 7 cm, interasse 13 cm.
One-hole 2-handle basin faucet with pop-up waste. Height spout 7 cm, Interaxis 13 cm.

ART.	13LI	13LICE
FINITURA FINISHING	VITONE TRADIZIONALE TRADITIONAL HEAD VALVE	VITONE CERAMICO CERAMIC HEAD VALVE



Monocomando lavabo con scarico.
Single-lever basin mixer with pop-up waste.

ART.	LA10
FINITURA FINISHING	VITONE TRADIZIONALE TRADITIONAL HEAD VALVE



Monocomando lavabo con scarico.
Single-lever basin mixer with pop-up waste.

ART.	LV10
FINITURA FINISHING	VITONE TRADIZIONALE TRADITIONAL HEAD VALVE



Miscelatore tradizionale bicomando monoforo per lavabo, con canna antica e scarico automatico. Altezza 23,5 cm, interasse 23 cm.
One-hole traditional 2-handle basin faucet, with "Antique" spout and pop-up waste.
 Height 23,5 cm, Interaxis 23 cm.

ART.	13ALI	13ALICE
FINITURA FINISHING	VITONE TRADIZIONALE TRADITIONAL HEAD VALVE	VITONE CERAMICO CERAMIC HEAD VALVE



Miscelatore tradizionale bicomando monoforo per lavabo, con canna tubo e scarico automatico. Altezza 29 cm, interasse 19 cm.
One-hole traditional 2-handle basin faucet, with tube spout and pop-up waste.
 Height 29 cm, Interaxis 19 cm.

ART.	13ULI	13ULICE
FINITURA FINISHING	VITONE TRADIZIONALE TRADITIONAL HEAD VALVE	VITONE CERAMICO CERAMIC HEAD VALVE



Gruppo lavabo tipo a ponte, canna Ø18 cm senza scarico. Altezza 28/28 cm, interasse 14,5 cm.
2-handle basin faucet bridge type, spout Ø18 cm without waste.
 Height 27/28 cm, Interaxis 14,5 cm.

ART.	14LI	14LICE
FINITURA FINISHING	VITONE TRADIZIONALE TRADITIONAL HEAD VALVE	VITONE CERAMICO CERAMIC HEAD VALVE

MISCELATORI BIDET - BIDET MIXERS



Batteria bidet con scarico automatico.
2-handle bidet faucet set with pop-up waste.

ART.	21LI	21LICE
FINITURA FINISHING	VITONE TRADIZIONALE TRADITIONAL HEAD VALVE	VITONE CERAMICO CERAMIC HEAD VALVE



Batteria bidet con doccia e scarico automatico.
2-handle bidet faucet with spray and pop-up waste.

ART.	22LI	22LICE
FINITURA FINISHING	VITONE TRADIZIONALE TRADITIONAL HEAD VALVE	VITONE CERAMICO CERAMIC HEAD VALVE



Batteria bidet con scarico.
2-handle bidet faucet with pop-up waste.
 Height 10,9 cm, Interaxis 11,5 cm.

ART.	20LI	20LICE
FINITURA FINISHING	VITONE TRADIZIONALE TRADITIONAL HEAD VALVE	VITONE CERAMICO CERAMIC HEAD VALVE



Miscelatore tradizionale bicomando monoforo bidet con scarico automatico.
One hole, 2-handle bidet faucet set with pop-up waste.

ART.	23LI	23LICE
FINITURA FINISHING	VITONE TRADIZIONALE TRADITIONAL HEAD VALVE	VITONE CERAMICO CERAMIC HEAD VALVE



Monocomando bidet con scarico.
Single-lever bidet mixer with pop-up waste.

ART.	LA20
FINITURA FINISHING	VITONE TRADIZIONALE TRADITIONAL HEAD VALVE



Monocomando bidet con scarico.
Single-lever bidet mixer with pop-up waste.

ART.	LV20
FINITURA FINISHING	VITONE TRADIZIONALE TRADITIONAL HEAD VALVE

MISCELATORI ESTERNI PER VASCA E DOCCIA - EXPOSED MIXERS FOR BATH AND SHOWER



Gruppo vasca con doccia duplex e doccetta in ottone ad 1 funzione e flessibile 150 cm.
2-handle bathtub faucet with duplex shower and 1 function brass handshower, flexible hose 150 cm.

ART. **02LI** **02LICE**

FINITURA FINISHING	VITONE TRADIZIONALE TRADITIONAL HEAD VALVE	VITONE CERAMICO CERAMIC HEAD VALVE



Gruppo vasca esterno su colonnette alte, con doccetta in ottone ad 1 funzione.
Traditional 2-handle bathtub faucet, on high columns, with 1 function brass handshower.

ART. **02LIUK** **02LICEUK**

FINITURA FINISHING	VITONE TRADIZIONALE TRADITIONAL HEAD VALVE	VITONE CERAMICO CERAMIC HEAD VALVE



Gruppo vasca senza kit doccia.
2-handle bathtub faucet without shower kit.

ART. **05LI** **05LICE**

FINITURA FINISHING	VITONE TRADIZIONALE TRADITIONAL HEAD VALVE	VITONE CERAMICO CERAMIC HEAD VALVE



Bordo vasca con doccetta in ottone ad 1 funzione estraibile e flessibile 150 cm.
Traditional 2-handle deck bathtub faucet with pull-out 1 function brass handshower and flexible hose 150 cm.

ART. **06LI** **06LICE**

FINITURA FINISHING	VITONE TRADIZIONALE TRADITIONAL HEAD VALVE	VITONE CERAMICO CERAMIC HEAD VALVE



Batteria vasca incasso con bocca, deviatore, doccetta in ottone ad 1 funzione con supporto snodato e flessibile 150 cm.
Built-in 2-handle bathtub faucet set with spout, diverter, 1 function brass handshower and swivel shower holder, flexible hose 150 cm.

ART. **03LIS01** **03LICES01**

FINITURA FINISHING	VITONE TRADIZIONALE TRADITIONAL HEAD VALVE	VITONE CERAMICO CERAMIC HEAD VALVE



Batteria vasca incasso con soffione e braccio da 30 cm tutto in ottone, deviatore, doccetta in ottone ad 1 funzione con supporto snodato e flessibile 150 cm.
Built-in 2-handle bathtub faucet set with shower head, shower arm 30 cm, diverter, 1 function brass handshower and swivel shower holder, flexible hose 150 cm. All in brass.

ART. **03LIS02** **03LICES02**

FINITURA FINISHING	VITONE TRADIZIONALE TRADITIONAL HEAD VALVE	VITONE CERAMICO CERAMIC HEAD VALVE



Gruppo vasca esterno su colonne da pavimento, con doccia.
Altezza bocca 60 cm, interasse 15/20 cm.
Traditional 2-handle bathtub faucet, on freestanding columns, with shower.
Height spout 60 cm, Interaxis 15/20 cm.

ART. **01LI** **01LICE**

FINITURA FINISHING	VITONE TRADIZIONALE TRADITIONAL HEAD VALVE	VITONE CERAMICO CERAMIC HEAD VALVE
-----------------------	---	---------------------------------------



8801LI
Colonne da pavimento, altezza 70 cm.
Floor freestanding columns, height 70 cm.



8801LIS
Coppia colonne vasca in ottone, con supporto doccia, 3/4M x 3/4M., altezza 80 cm.
Couple of brass vertical connections for bath faucet, with handshower holder 3/4M x 3/4M, height 80 cm.



Gruppo vasca con deviatore e attacco 3/4M.
2-handle bathtub faucet with diverter and 3/4M connection.

ART. **07LI** **07LICE**

FINITURA FINISHING	VITONE TRADIZIONALE TRADITIONAL HEAD VALVE	VITONE CERAMICO CERAMIC HEAD VALVE
-----------------------	---	---------------------------------------



Gruppo vasca-doccia tradizionale, con colonna saliscendi, con deviatore, doccetta, flessibile e soffione doccia. Tutto in ottone.
Traditional 2-handle shower/bathtub faucet with sliding rail column with diverter and handshower, with shower hose and shower head. All in chrome plated brass.

ART. **09LIB20** **09LICEB20**

FINITURA FINISHING	VITONE TRADIZIONALE TRADITIONAL HEAD VALVE	VITONE CERAMICO CERAMIC HEAD VALVE
-----------------------	---	---------------------------------------



Gruppo vasca/doccia con colonna doccia lusso e soffione doccia in ottone.
2-handle shower/bathtub faucet with deluxe pipe and shower head.

ART. **08LIB20** **08LICEB20**

FINITURA FINISHING	VITONE TRADIZIONALE TRADITIONAL HEAD VALVE	VITONE CERAMICO CERAMIC HEAD VALVE
-----------------------	---	---------------------------------------

SALISCENDI E COLONNE DOCCIA - SLIDING RAILS AND SHOWER COLUMNS



Gruppo doccia con colonna saliscendi e deviatore, completa di doccetta con flessibile e soffione a campanella, tutto in ottone.
 Wall mounted 2-handle shower faucet with deluxe sliding rail column and diverter, complete with handshower, flexible hose and shower head bell shaped, all in brass.

ART. **37LIRB20** **37LICERB20**

FINITURA FINISHING	VITONE TRADIZIONALE TRADITIONAL HEAD VALVE	VITONE CERAMICO CERAMIC HEAD VALVE
--------------------	--	------------------------------------

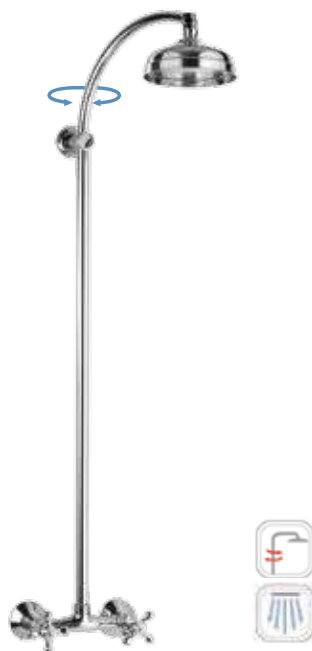

Gruppo doccia con colonna lusso e soffione doccia a campanella, tutto in ottone.
 Wall mounted 2-handle shower faucet with deluxe pipe and brass shower rose bell shaped.

ART. **36LIRB20** **36LICERB20**

FINITURA FINISHING	VITONE TRADIZIONALE TRADITIONAL HEAD VALVE	VITONE CERAMICO CERAMIC HEAD VALVE
--------------------	--	------------------------------------



317L323CR
 Saliscendi lusso, con asta tonda e doccetta, tutto in ottone.
 Luxury sliding rail set, with round rod and handshower, all in brass.



Gruppo doccia a muro con attacco superiore 3/4" M.
 Wall mounted 2-handle shower faucet with upper connection 3/4" M connection.

ART. **35LI** **35LICE**

FINITURA FINISHING	VITONE TRADIZIONALE TRADITIONAL HEAD VALVE	VITONE CERAMICO CERAMIC HEAD VALVE
--------------------	--	------------------------------------



Gruppo doccia a muro, senza kit doccia.
 Wall mounted 2-handle shower faucet without shower kit.

ART. **38LI** **38LICE**

FINITURA FINISHING	VITONE TRADIZIONALE TRADITIONAL HEAD VALVE	VITONE CERAMICO CERAMIC HEAD VALVE
--------------------	--	------------------------------------



Gruppo doccia a muro con doccia duplex.
 Wall mounted 2-handle shower faucet with duplex shower.

ART. **39LI** **39LICE**

FINITURA FINISHING	VITONE TRADIZIONALE TRADITIONAL HEAD VALVE	VITONE CERAMICO CERAMIC HEAD VALVE
--------------------	--	------------------------------------



LV30
 Miscelatore monocomando da incasso senza deviatore.
 Built-in single-lever mixer without diverter.



LV09
 Miscelatore monocomando da incasso con deviatore per vasca/doccia.
 Built-in bath/shower single-lever mixer with diverter.



LA30
 Miscelatore monocomando da incasso senza deviatore.
 Built-in single-lever mixer without diverter.



LA09
 Miscelatore monocomando da incasso con deviatore per vasca/doccia.
 Built-in bath/shower single-lever mixer with diverter.



317L323CR

MISCELATORI CUCINA - KITCHEN MIXERS



Gruppo lavello a muro con canna inferiore, lunghezza canna 18 cm.
Sink mixer wall mounted tap, with swivel spout, length spout 18 cm.

ART. **41LI** **41LICE**

FINITURA FINISHING	VITONE TRADIZIONALE TRADITIONAL HEAD VALVE	VITONE CERAMICO CERAMIC HEAD VALVE
-----------------------	---	---------------------------------------



Gruppo lavello a muro con canna superiore, lunghezza canna 17,5 cm.
Sink mixer wall mounted, with swivel high spout, length spout 17,5 cm.

ART. **41SLI** **41SLICE**

FINITURA FINISHING	VITONE TRADIZIONALE TRADITIONAL HEAD VALVE	VITONE CERAMICO CERAMIC HEAD VALVE
-----------------------	---	---------------------------------------



Gruppo lavello a muro con canna superiore Jota.
Altezza 25 cm, interasse 17 cm.
Sink mixer wall mounted, with swivel high J spout.
Height 25 cm, Interaxis 17 cm.

ART. **41LIJ** **41LIJCE**

FINITURA FINISHING	VITONE TRADIZIONALE TRADITIONAL HEAD VALVE	VITONE CERAMICO CERAMIC HEAD VALVE
-----------------------	---	---------------------------------------



Gruppo lavello bicomando monoforo con canna girevole.
Altezza 25 cm, interasse 22,5 cm.
One-hole dual control sink mixer with swivel spout.
Height 25 cm, Interaxis 22,5 cm.

ART. **43LI** **43LICE**

FINITURA FINISHING	VITONE TRADIZIONALE TRADITIONAL HEAD VALVE	VITONE CERAMICO CERAMIC HEAD VALVE
-----------------------	---	---------------------------------------



Miscelatore tradizionale bicomando per lavello con canna antica.
Altezza 23,5 cm, interasse 23 cm.
One-hole dual control sink mixer with antique spout.
Height 23,5 cm, Interaxis 23 cm.

ART. **43LIA** **43LIACE**

FINITURA FINISHING	VITONE TRADIZIONALE TRADITIONAL HEAD VALVE	VITONE CERAMICO CERAMIC HEAD VALVE
-----------------------	---	---------------------------------------



Gruppo lavello monoforo bicomando con canna Jota.
Altezza 27 cm, interasse 18 cm.
One-hole sink mixer dual control with swivel J spout.
Height 27 cm, Interaxis 18 cm.

ART. **43LIJ** **43LIJCE**

FINITURA FINISHING	VITONE TRADIZIONALE TRADITIONAL HEAD VALVE	VITONE CERAMICO CERAMIC HEAD VALVE
-----------------------	---	---------------------------------------



Gruppo lavello a muro bicomando con canna superiore antica.
Altezza 22 cm, interasse 23 cm.
Dual control sink mixer, wall mounted, with swivel high antique spout.
Height 22 cm, Interaxis 23 cm.

ART. **41LIA** **41LIACE**

FINITURA FINISHING	VITONE TRADIZIONALE TRADITIONAL HEAD VALVE	VITONE CERAMICO CERAMIC HEAD VALVE
-----------------------	---	---------------------------------------



Rubinetto prolungato, 1/2".
Wall mounted long tap, 1/2".

ART. **51LI** **51LICE**

FINITURA FINISHING	VITONE TRADIZIONALE TRADITIONAL HEAD VALVE	VITONE CERAMICO CERAMIC HEAD VALVE
-----------------------	---	---------------------------------------

LINEA MONO ACQUA - SINGLE WATER LINE



Rubinetto collo cigno 1/2, 3/4.
Wash basin pillar tap, 1/2, 3/4.

1/2		
ART.	15LI	15LICE
FINITURA FINISHING	VITONE TRADIZIONALE TRADITIONAL HEAD VALVE	VITONE CERAMICO CERAMIC HEAD VALVE



Rubinetto incasso dritto 1/2, 3/4.
Built-in straight stop cock, 1/2, 3/4.

ART.			31LI	31LICE
FINITURA FINISHING	VITONE TRADIZIONALE TRADITIONAL HEAD VALVE	VITONE CERAMICO CERAMIC HEAD VALVE		



Rubinetto con portagomma, 1/2".
Wall mounted hose-holder tap, 1/2",

ART.			52LI	52LICE
FINITURA FINISHING	VITONE TRADIZIONALE TRADITIONAL HEAD VALVE	VITONE CERAMICO CERAMIC HEAD VALVE		

3/4		
ART.	15LI34	15LI34CE
FINITURA FINISHING	VITONE TRADIZIONALE TRADITIONAL HEAD VALVE	VITONE CERAMICO CERAMIC HEAD VALVE



Rubinetto a squadra per lavatrice, 1/2" x 3/4".
Angle tap for washing machine 1/2" x 3/4".

ART.			55LI	55LICE
FINITURA FINISHING	VITONE TRADIZIONALE TRADITIONAL HEAD VALVE	VITONE CERAMICO CERAMIC HEAD VALVE		



Rubinetto a squadra per lavatrice 1/2" x 1/2"
Angle tap for washing machine 1/2" x 1/2"

ART.			5512LI	5512LICE
FINITURA FINISHING	VITONE TRADIZIONALE TRADITIONAL HEAD VALVE	VITONE CERAMICO CERAMIC HEAD VALVE		



Rubinetto a snodo pesante, 1/2" con canna alta "S" Ø 18 girevole, con rompigetto.
Sink tap 1/2" with high "S" swivel spout Ø 18, and aerator.

ART.			53SLI	53SLICE
FINITURA FINISHING	VITONE TRADIZIONALE TRADITIONAL HEAD VALVE	VITONE CERAMICO CERAMIC HEAD VALVE		



Rubinetto a snodo pesante, 1/2" canna alta "J", Ø 18, con canna girevole e rompigetto.
Sink tap 1/2", with high "J" swivel spout Ø 18 and aerator.

ART.			53JLI	53JLICE
FINITURA FINISHING	VITONE TRADIZIONALE TRADITIONAL HEAD VALVE	VITONE CERAMICO CERAMIC HEAD VALVE		



Rubinetto monoforo per lavello con canna alta a "J" e rompigetto.
One-hole sink tap, with high "J" swivel spout and aerator.

ART.			54LI	54LICE
FINITURA FINISHING	VITONE TRADIZIONALE TRADITIONAL HEAD VALVE	VITONE CERAMICO CERAMIC HEAD VALVE		



Rubinetto a snodo pesante, 1/2" canna Ø 18, con rompigetto.
Sink tap, with swivel spout Ø18, 1/2" and aeraor.

ART.			53LI	53LICE
FINITURA FINISHING	VITONE TRADIZIONALE TRADITIONAL HEAD VALVE	VITONE CERAMICO CERAMIC HEAD VALVE		



Rubinetto curvo con maniglia MINI Y, 1/2".
Elbow tap with MINI Y handle, 1/2".

ART.			57LI	57LICE
FINITURA FINISHING	VITONE TRADIZIONALE TRADITIONAL HEAD VALVE	VITONE CERAMICO CERAMIC HEAD VALVE		



Rubinetto curvo con uscita da 1/2" e uscita da bocca di erogazione, attacco 1/2" M.
Angle tap with 1/2" output and spout output, 1/2" M connection.

ART.			251LI	251LICE
FINITURA FINISHING	VITONE TRADIZIONALE TRADITIONAL HEAD VALVE	VITONE CERAMICO CERAMIC HEAD VALVE		



Rubinetto a snodo con attacco lavatrice e attacco da 1/2" con canna ad S girevole.
Washing machine bibcock, with swivel spout 1/2".

ART.			252LI	252LICE
FINITURA FINISHING	VITONE TRADIZIONALE TRADITIONAL HEAD VALVE	VITONE CERAMICO CERAMIC HEAD VALVE		

METRICA

ENERGY / ECO

SLASH / DOT

ABSOLUTE

INFINITY

VANITY

DREAM

CLASS LINE

WINNER / ECO

LIBERTY





WELLNESS

BOX INCASSO BUILT-IN BOXES

PER MISCELATORE VASCA-DOCCIA A 1 O 2 VIE
FOR 1 OR 2-WAY BATH-SHOWER MIXER



A Cartuccia Termostatica.
Thermostatic Cartridge.

B Cartuccia Ø 40.
Ø 40 Cartridge.

C Cartuccia Ø 35.
Ø 35 Cartridge.

Utilizzando il codice RR BOX (box incasso per miscelatore vasca-doccia a 1 o 2 vie) possono essere gestite tutte le combinazioni che prevedono 1 (o nessuna) deviazione.

Alcune delle possibili combinazioni:

- solo soffione doccia / solo doccetta
- soffione doccia + doccetta
- bocca a parete + saliscendi
- bocca per vasca + soffione
- bocca per vasca + doccetta
- soffione + getti doccia

Grazie al ridotto spessore delle BOX di REMER Rubinerterie è possibile l'installazione in cartongessi e pareti in legno.

La RRBOX è prodotta con materiale ad alta densità, selezionato per essere pratico al taglio, durevole nel tempo, protettivo, resistente e insonorizzante. Il prodotto è sempre ispezionabile nel tempo.

Using the RR BOX code (built-in box for 1 or 2-way bath-shower mixer), all the combinations that require 1 (or no) deviation can be managed.

Some of the possible combinations:

- shower head only / hand shower only
- shower head + hand shower
- wall spout + sliding rail
- bath spout + shower head
- spout for bathtub + hand shower
- shower head + shower jets

Thanks to the reduced thickness of REMER Rubinerterie BOXES, it can be installed in plasterboard and wooden walls.

The RR BOX is made of High-density material, chosen for its practicality when cutting, long-term durability, protective properties, resistance and soundproofing qualities. The product remains accessible for inspection over time.



ATELIER



CHRONO



CELEBRITY



ELEMENT



ET30KB **ET09KB**

CR
FIN 1
FIN 2

CR
FIN 1
FIN 2

Q DESIGN



Z30KB **Z09KB**

CR
FIN 1
FIN 2

CR
FIN 1
FIN 2

X-STYLE



X30KB **X09KB**

CR
FIN 1
FIN 2

CR
FIN 1
FIN 2

METRICA



MC30KB **MC09KB**

CR
FIN 1
FIN 2

CR
FIN 1
FIN 2

ENERGY



EY30KB **EY09KB**

CR
FIN 1

CR
FIN 1

SLASH



SL30KB **SL09KB**

CR
FIN 1

CR
FIN 1

DOT



DT30KB **DT09KB**

CR
FIN 1

CR
FIN 1

ABSOLUTE



AU30KB **AU09KB**

CR
FIN 1
FIN 2

CR
FIN 1
FIN 2

INFINITY



I30KB **I09KB**

CR
FIN 1
FIN 2

CR
FIN 1
FIN 2

VANITY



V30KB **V09KB**

CR
FIN 1
FIN 2

CR
FIN 1
FIN 2

DREAM



D30KB **D09KB**

CR
FIN 1

CR
FIN 1

CLASS LINE



L30KB **L09KB**

CR
FIN 1

CR
FIN 1

WINNER



W30KB **W09KB**

CR
FIN 1

CR
FIN 1

MINIMAL THERMO



NT30KB **NT09KB**

CR
FIN 1

CR
FIN 1

QUBIKA THERMO



QT30KB **QT09KB**

CR
FIN 1

CR
FIN 1

BOX INCASSO BUILT-IN BOXES

PER MISCELATORE VERTICALE VASCA-DOCCIA CON
DEVIATORE A DISCHI CERAMICI, 2 VIE E 2 POSIZIONI
VERTICAL BATH-SHOWER MIXER WITH CERAMIC
DISC DIVERTER, 2-WAY AND 2-POSITIONS



Utilizzando il codice WBOX92 - box incasso VERTICALE per miscelatore vasca doccia con deviatore a 2 vie a dischi ceramici e 2 posizioni - possono essere gestite tutte le combinazioni a due uscite.

Alcune delle possibili combinazioni:

- soffione doccia + doccetta
- bocca a parete + saliscendi
- bocca per vasca + soffione
- bocca per vasca + doccetta
- soffione + getti doccia

Grazie alla guarnizione perimetrale di tenuta, le WBOX garantiscono un'impeccabile impermeabilizzazione delle connessioni e delle parti incassate. In caso di anomalie dovute a installazioni o allacciamenti non corretti, l'acqua viene immediatamente segnalata da un trafilemento frontale, evitando qualsiasi infiltrazione all'interno della muratura e offrendo un sistema di sicurezza che permette un intervento tempestivo e mirato.

By using the WBOX92 - VERTICAL built-in box for bath-shower mixer with 2-way ceramic disc diverter and 2 positions - all two outlets solutions can be combined.

Some of the possible combinations include:

- shower head + hand shower
- wall spout + slide rail
- bathtub spout + shower head
- bathtub spout + hand shower
- shower head + body jets

Thanks to the perimeter sealing gasket, the WBOX ensures exceptional waterproofing of connections and built-in components, providing long-lasting reliability and peace of mind. In the unlikely event of an issue due to incorrect installation or connections, water is promptly and visibly directed to the front, avoiding any risk of infiltration into the wall structure. This innovative safety feature guarantees effortless detection and allows for quick, targeted intervention, ensuring complete confidence in the product's performance and durability.



ATELIER



AL92PWB

CR
FIN 1
FIN 2



AL92WB

CR
FIN 1
FIN 2

CHRONO



CH92PWB

CR
FIN 1
FIN 2



CH92WB

CR
FIN 1
FIN 2

CELEBRITY



CEC92PWB

CR
FIN 1
FIN 2



CEC92WB

CR
FIN 1
FIN 2

ELEMENT



ET92PWB

ET92WB

CR
FIN 1
FIN 2

CR
FIN 1
FIN 2

Q DESIGN

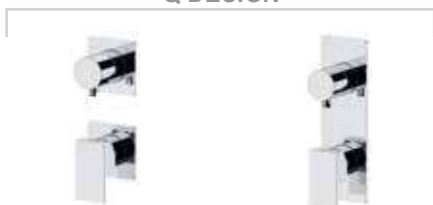

QD92PWB

QD92WB

CR
FIN 1
FIN 2

CR
FIN 1
FIN 2

X-STYLE



X92PWB

X92WB

CR
FIN 1
FIN 2

CR
FIN 1
FIN 2

METRICA



MC92PWB

MC92WB

CR
FIN 1
FIN 2

CR
FIN 1
FIN 2

ENERGY

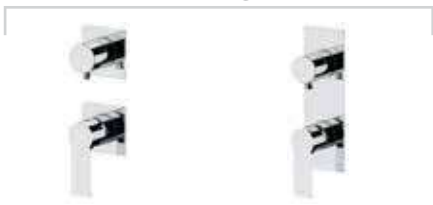

EY92PWB

EY92WB

CR
FIN 1

CR
FIN 1

SLASH

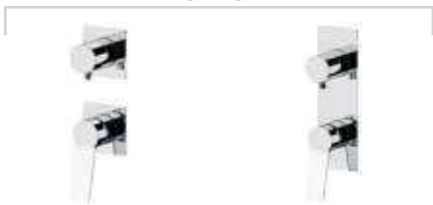

SL92PWB

SL92WB

CR
FIN 1

CR
FIN 1

DOT



DT92PWB

DT92WB

CR
FIN 1

CR
FIN 1

ABSOLUTE

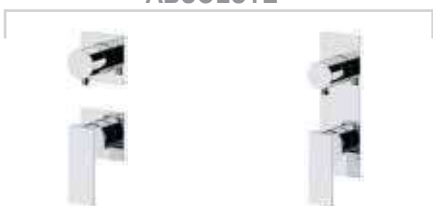

AU92PWB

AU92WB

CR
FIN 1
FIN 2

CR
FIN 1
FIN 2

INFINITY



I92PWB

I92WB

CR
FIN 1
FIN 2

CR
FIN 1
FIN 2

VANITY



V92PWB

V92WB

CR
FIN 1
FIN 2

CR
FIN 1
FIN 2

DREAM



D92PWB

D92WB

CR
FIN 1

CR
FIN 1

CLASS LINE



L92PWB

L92WB

CR
FIN 1

CR
FIN 1

WINNER

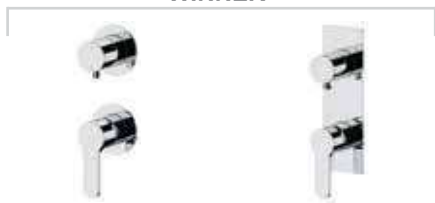

W92PWB

W92WB

CR
FIN 1

CR
FIN 1

BOX INCASSO
BUILT-IN BOX
A PULSANTE
PUSH-BUTTON
TERMOSTATICI
THERMOSTATICS
COLONNE DOCCIA
SHOWER COLUMNS
KIT WELLNESS
WELLNESS KIT
CROMOTERAPIA
COLOR THERAPY
SOFFIONI
SHOWER HEADS
BOCCHE
SPOUTS
PANNELLI DOCCIA
SHOWER PANELS
SALISCENDI
SLIDING RAILS
DOCCETTE
HANDSHOWERS
BORDO VASCA
DECK BATH MIXERS

BOX INCASSO BUILT-IN BOXES

PER MISCELATORE VERTICALE VASCA-DOCCIA CON
DEVIATORE A DISCHI CERAMICI, 3 VIE E 3 POSIZIONI
*VERTICAL BATH-SHOWER MIXER WITH CERAMIC
DISC DIVERTER, 3-WAY AND 3-POSITIONS*



Utilizzando il codice WBOX93 - box incasso VERTICALE per miscelatore vasca doccia con deviatore a 3 vie a dischi ceramici e 3 posizioni - possono essere gestite tutte le combinazioni a tre uscite.

Alcune delle possibili combinazioni:

- saliscendi + soffione doccia con getti a pioggia + a cascata
- doccetta + soffione doccia con getti a pioggia + a cascata
- bocca di erogazione + saliscendi + soffione
- soffione doccia + getti + doccetta

Grazie alla guarnizione perimetrale di tenuta, le WBOX garantiscono un'impeccabile impermeabilizzazione delle connessioni e delle parti incassate. In caso di anomalie dovute a installazioni o allacciamenti non corretti, l'acqua viene immediatamente segnalata da un trafilamento frontale, evitando qualsiasi infiltrazione all'interno della muratura e offrendo un sistema di sicurezza che permette un intervento tempestivo e mirato.

By using the WBOX93 - VERTICAL built-in box for bath-shower mixer with 3-way ceramic disc diverter and 3 positions - all three outlets solutions can be combined.

Some of the possible combinations include:

- sliding rail + shower head with rain jet and waterfall jet
- hand shower + shower head with rain and waterfall jet
- wall mounted spout + sliding rail + shower head
- shower head + shower jets + hand shower

Thanks to the perimeter sealing gasket, the WBOX ensures exceptional waterproofing of connections and built-in components, providing long-lasting reliability and peace of mind. In the unlikely event of an issue due to incorrect installation or connections, water is promptly and visibly directed to the front, avoiding any risk of infiltration into the wall structure. This innovative safety feature guarantees effortless detection and allows for quick, targeted intervention, ensuring complete confidence in the product's performance and durability.



Cod. WBOX93

ATELIER



AL93PWB

CR
FIN 1
FIN 2



AL93WB

CR
FIN 1
FIN 2

CHRONO



CH93PWB

CR
FIN 1
FIN 2



CH93WB

CR
FIN 1
FIN 2

CELEBRITY



CEC93PWB

CR
FIN 1
FIN 2



CEC93WB

CR
FIN 1
FIN 2

ELEMENT



ET93PWB

ET93WB

CR
FIN 1
FIN 2

CR
FIN 1
FIN 2

Q DESIGN

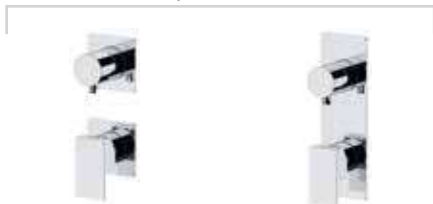

QD93PWB

QD93WB

CR
FIN 1
FIN 2

CR
FIN 1
FIN 2

X-STYLE



X93PWB

X93WB

CR
FIN 1
FIN 2

CR
FIN 1
FIN 2

METRICA



MC93PWB

MC93WB

CR
FIN 1
FIN 2

CR
FIN 1
FIN 2

ENERGY

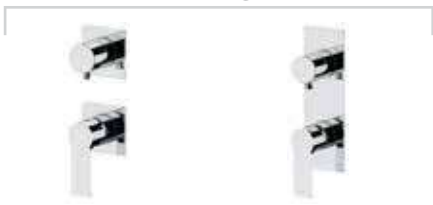

EY93PWB

EY93WB

CR
FIN 1

CR
FIN 1

SLASH

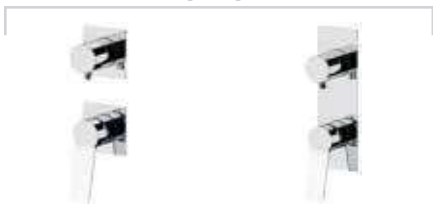

SL93PWB

SL93WB

CR
FIN 1

CR
FIN 1

DOT



DT93PWB

DT93WB

CR
FIN 1

CR
FIN 1

ABSOLUTE

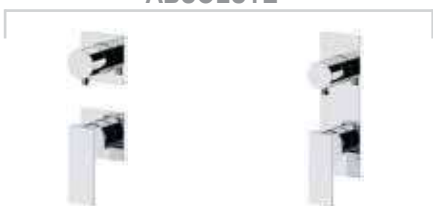

AU93PWB

AU93WB

CR
FIN 1
FIN 2

CR
FIN 1
FIN 2

INFINITY



I93PWB

I93WB

CR
FIN 1
FIN 2

CR
FIN 1
FIN 2

VANITY



V93PWB

V93WB

CR
FIN 1
FIN 2

CR
FIN 1
FIN 2

DREAM



D93PWB

D93WB

CR
FIN 1

CR
FIN 1

CLASS LINE



L93PWB

L93WB

CR
FIN 1

CR
FIN 1

WINNER

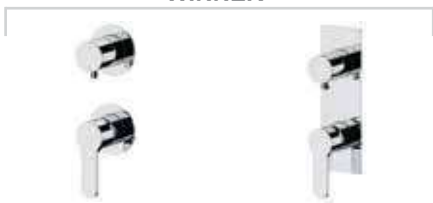

W93PWB

W93WB

CR
FIN 1

CR
FIN 1

BOX INCASSO
BUILT-IN BOX
A PULSANTE
PUSH-BUTTON
TERMOSTATICI
THERMOSTATICS
COLONNE DOCCIA
SHOWER COLUMNS
KIT WELLNESS
WELLNESS KIT
CROMOTERAPIA
COLORTHERAPY
SOFFIONI
SHOWER HEADS
BOCCHE
SPOUTS
PANNELLI DOCCIA
SHOWER PANELS
SALISCENDI
SLIDING RAILS
DOCCETTE
HANDSHOWERS
BORDO VASCA
DECK BATH MIXERS

BOX INCASSO BUILT-IN BOXES

PER MISCELATORE ORIZZONTALE VASCA-DOCCIA CON
DEVIATORE A DISCHI CERAMICI, 2 VIE E 2 POSIZIONI
*HORIZONTAL BATH-SHOWER MIXER WITH CERAMIC
DISC DIVERTER, 2-WAY AND 2-POSITIONS*



Utilizzando il codice WBOX92Z - box incasso ORIZZONTALE per miscelatore vasca doccia con deviatore a 2 vie a dischi ceramici e 2 posizioni - possono essere gestite tutte le combinazioni a due uscite.

Alcune delle possibili combinazioni:

- soffione doccia + doccetta
- bocca a parete + saliscendi
- bocca per vasca + soffione
- bocca per vasca + doccetta
- soffione + getti doccia

Grazie alla guarnizione perimetrale di tenuta, le WBOX garantiscono un'impeccabile impermeabilizzazione delle connessioni e delle parti incassate. In caso di anomalie dovute a installazioni o allacciamenti non corretti, l'acqua viene immediatamente segnalata da un trafilemento frontale, evitando qualsiasi infiltrazione all'interno della muratura e offrendo un sistema di sicurezza che permette un intervento tempestivo e mirato.

By using the WBOX92Z - HORIZONTAL built-in box for bath-shower mixer with 2-way ceramic disc diverter and 2 positions - all two outlets solutions can be combined.

Some of the possible combinations include:

- shower head + hand shower
- wall spout + slide rail
- bathtub spout + shower head
- bathtub spout + hand shower
- shower head + body jets

Thanks to the perimeter sealing gasket, the WBOX ensures exceptional waterproofing of connections and built-in components, providing long-lasting reliability and peace of mind. In the unlikely event of an issue due to incorrect installation or connections, water is promptly and visibly directed to the front, avoiding any risk of infiltration into the wall structure. This innovative safety feature guarantees effortless detection and allows for quick, targeted intervention, ensuring complete confidence in the product's performance and durability.

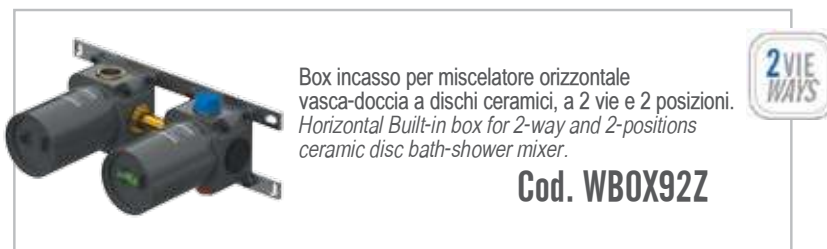

ATELIER



AL92ZPWB

AL92ZWB

CHRONO



CH92ZPWB

CH92ZWB

CELEBRITY



CEC92ZPWB

CEC92ZWB

CR	CR	CR	CR	CR	CR
FIN 1	FIN 1	FIN 1	FIN 1	FIN 1	FIN 1
FIN 2	FIN 2	FIN 2	FIN 2	FIN 2	FIN 2

INCASSI CON WBOX92Z - BUILT-IN WITH WBOX92Z

ELEMENT



ET92ZPWB

ET92ZWB

CR
FIN 1
FIN 2

CR
FIN 1
FIN 2

Q DESIGN



QD92ZPWB

QD92ZWB

CR
FIN 1
FIN 2

CR
FIN 1
FIN 2

X-STYLE



X92ZPWB

X92ZWB

CR
FIN 1
FIN 2

CR
FIN 1
FIN 2

METRICA



MC92ZPWB

MC92ZWB

CR
FIN 1
FIN 2

CR
FIN 1
FIN 2

ENERGY

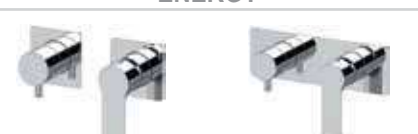

EY92ZPWB

EY92ZWB

CR
FIN 1

CR
FIN 1

SLASH



SL92ZPWB

SL92ZWB

CR
FIN 1

CR
FIN 1

DOT



DT92ZPWB

DT92ZWB

CR
FIN 1

CR
FIN 1

ABSOLUTE

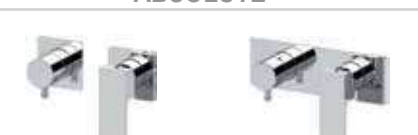

AU92ZPWB

AU92ZWB

CR
FIN 1
FIN 2

CR
FIN 1
FIN 2

INFINITY



I92ZPWB

I92ZWB

CR
FIN 1
FIN 2

CR
FIN 1
FIN 2

VANITY



V92ZPWB

V92ZWB

CR
FIN 1
FIN 2

CR
FIN 1
FIN 2

DREAM



D92ZPWB

D92ZWB

CR
FIN 1

CR
FIN 1

CLASS LINE



L92ZPWB

L92ZWB

CR
FIN 1

CR
FIN 1

WINNER

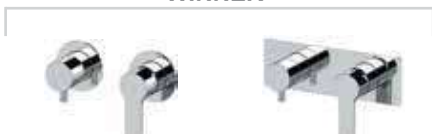

W92ZPWB

W92ZWB

CR
FIN 1

CR
FIN 1

BOX INCASSO
BUILT-IN BOX
A PULSANTE
PUSH-BUTTON
TERMOSTATICI
THERMOSTATICS
COLONNE DOCCIA
SHOWER COLUMNS
KIT WELLNESS
WELLNESS KIT
CROMOTERAPIA
COLOR THERAPY
SOFFIONI
SHOWER HEADS
BOCCHE
SPOUTS
PANNELLI DOCCIA
SHOWER PANELS
SALISCENDI
SLIDING RAILS
DOCCETTE
HANDSHOWERS
BORDO VASCA
DECK BATH MIXERS

BOX INCASSO BUILT-IN BOXES

PER MISCELATORE ORIZZONTALE VASCA-DOCCIA CON
DEVIATORE A DISCHI CERAMICI, 3 VIE E 3 POSIZIONI
*HORIZONTAL BATH-SHOWER MIXER WITH CERAMIC
DISC DIVERTER, 3-WAY AND 3-POSITIONS*



WBOX93Z

Utilizzando il codice WBOX93Z - box incasso ORIZZONTALE per miscelatore vasca doccia con deviatore a 3 vie a dischi ceramici e 3 posizioni - possono essere gestite tutte le combinazioni a tre uscite.

Alcune delle possibili combinazioni:

- saliscendi + soffione doccia con getti a pioggia + a cascata
- doccetta + soffione doccia con getti a pioggia + a cascata
- bocca di erogazione + saliscendi + soffione
- soffione doccia + getti + doccetta

Grazie alla guarnizione perimetrale di tenuta, le WBOX garantiscono un'impeccabile impermeabilizzazione delle connessioni e delle parti incassate. In caso di anomalie dovute a installazioni o allacciamenti non corretti, l'acqua viene immediatamente segnalata da un trafilemento frontale, evitando qualsiasi infiltrazione all'interno della muratura e offrendo un sistema di sicurezza che permette un intervento tempestivo e mirato.

By using the WBOX93Z - HORIZONTAL built-in box for bath-shower mixer with 3-way ceramic disc diverter and 3 positions - all three outlets solutions can be combined.

Some of the possible combinations include:

- sliding rail + shower head with rain jet and waterfall jet
- hand shower + shower head with rain and waterfall jet
- wall mounted spout + sliding rail + shower head
- shower head + shower jets + hand shower

Thanks to the perimeter sealing gasket, the WBOX ensures exceptional waterproofing of connections and built-in components, providing long-lasting reliability and peace of mind. In the unlikely event of an issue due to incorrect installation or connections, water is promptly and visibly directed to the front, avoiding any risk of infiltration into the wall structure. This innovative safety feature guarantees effortless detection and allows for quick, targeted intervention, ensuring complete confidence in the product's performance and durability.

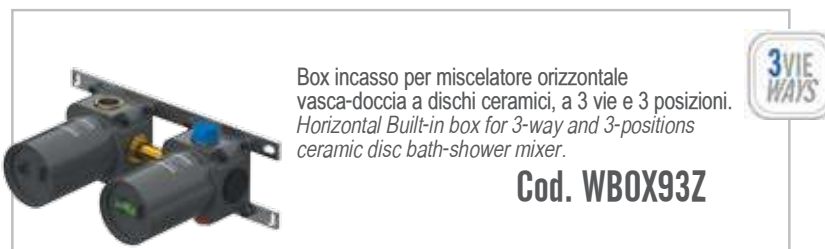

Box incasso per miscelatore orizzontale
vasca-doccia a dischi ceramici, a 3 vie e 3 posizioni.
*Horizontal Built-in box for 3-way and 3-positions
ceramic disc bath-shower mixer.*

Cod. WBOX93Z

ATELIER



AL93ZPWB

CR
FIN 1
FIN 2

AL93ZWB

CR
FIN 1
FIN 2

CHRONO



CH93ZPWB

CR
FIN 1
FIN 2

CH93ZWB

CR
FIN 1
FIN 2

CELEBRITY



CEC93ZPWB

CR
FIN 1
FIN 2

CEC93ZWB

CR
FIN 1
FIN 2

INCASSI CON WBOX93Z - BUILT-IN WITH WBOX93Z

ELEMENT



ET93ZPWB **ET93ZWB**

CR	CR
FIN 1	FIN 1
FIN 2	FIN 2

Q DESIGN



QD93ZPWB **QD93ZWB**

CR	CR
FIN 1	FIN 1
FIN 2	FIN 2

X-STYLE



X93ZPWB **X93ZWB**

CR	CR
FIN 1	FIN 1
FIN 2	FIN 2

METRICA



MC93ZPWB **MC93ZWB**

CR	CR
FIN 1	FIN 1
FIN 2	FIN 2

ENERGY



EY93ZPWB **EY93ZWB**

CR	CR
FIN 1	FIN 1

SLASH



SL93ZPWB **SL93ZWB**

CR	CR
FIN 1	FIN 1

DOT



DT93ZPWB **DT93ZWB**

CR	CR
FIN 1	FIN 1

ABSOLUTE



AU93ZPWB **AU93ZWB**

CR	CR
FIN 1	FIN 1
FIN 2	FIN 2

INFINITY



I93ZPWB **I93ZWB**

CR	CR
FIN 1	FIN 1
FIN 2	FIN 2

VANITY



V93ZPWB **V93ZWB**

CR	CR
FIN 1	FIN 1
FIN 2	FIN 2

DREAM



D93ZPWB **D93ZWB**

CR	CR
FIN 1	FIN 1

CLASS LINE



L93ZPWB **L93ZWB**

CR	CR
FIN 1	FIN 1

WINNER



W93ZPWB **W93ZWB**

CR	CR
FIN 1	FIN 1

BOX INCASSO
BUILT-IN BOX
A PULSANTE
PUSH-BUTTON
TERMOSTATICI
THERMOSTATICS
COLONNE DOCCIA
SHOWER COLUMNS
KIT WELLNESS
WELLNESS KIT
CROMOTERAPIA
COLOR THERAPY
SOFFIONI
SHOWER HEADS
BOCCHE
SPOUTS
PANNELLI DOCCIA
SHOWER PANELS
SALISCENDI
SLIDING RAILS
DOCCETTE
HANDSHOWERS
BORDO VASCA
DECK BATH MIXERS

BOX INCASSO BUILT-IN BOXES

PER MISCELATORE ORIZZONTALE VASCA-DOCCIA 2 VIE CON DEVIATORE A DISCHI CERAMICI E 2 POSIZIONI. PRESENTA UNA DELLE DUE USCITE GIA' IN LINEA DEFINITA NELL'INTERASSE.
HORIZONTAL BATH-SHOWER MIXER WITH 2-WAY CERAMIC DISC DIVERTER AND 2 POSITIONS, ENGINEERED WITH ONE OF THE TWO OUTLETS ALIGNED IN THE SAME ROW AS THE MIXER UNIT, MAINTAINING A FIXED AND ACCURATE SPACING.



WBOX97D2

Utilizzando il codice WBOX97D2 - box incasso ORIZZONTALE per miscelatore vasca doccia con deviatore a 2 vie a dischi ceramici e 2 posizioni - possono essere gestite tutte le combinazioni a due uscite. Alcune delle possibili combinazioni:

- doccia + soffione
- bocca di erogazione + soffione
- bocca di erogazione + doccia

Le WBOX incasso di Remer Rubinetterie sono realizzate utilizzando i migliori materiali e tecnologie produttive high-tech. La materia prima utilizzata per i WBOX è stata appositamente selezionata per essere pratica al taglio, durevole nel tempo e protettiva.

Grazie alla guarnizione perimetrale di tenuta, le WBOX garantiscono un'impeccabile impermeabilizzazione delle connessioni e delle parti incassate. In caso di anomalie dovute a installazioni o allacciamenti non corretti, l'acqua viene immediatamente segnalata da un trafileamento frontale, evitando qualsiasi infiltrazione all'interno della muratura e offrendo un sistema di sicurezza che permette un intervento tempestivo e mirato.

By using the WBOX97D2 - HORIZONTAL built-in box for bath-shower mixer with 2-way ceramic disc diverter and 2 positions - all two outlets solutions can be combined.

Some of the possible combinations include:

- hand shower + shower head
- wall mounted spout + shower head
- wall mounted spout + hand shower

The built-in WBOX units from Remer Rubinetterie are produced using the premium materials and high-tech production technologies.

The raw material used for WBOX has been specifically selected to be easy to cut, highly durable, and protective.

Thanks to the perimeter sealing gasket, the WBOX ensures exceptional waterproofing of connections and built-in components, providing long-lasting reliability and peace of mind. In the unlikely event of an issue due to incorrect installation or connections, water is promptly and visibly directed to the front, avoiding any risk of infiltration into the wall structure.

This innovative safety feature guarantees effortless detection and allows for quick, targeted intervention, ensuring complete confidence in the product's performance and durability.



Box incasso per miscelatore orizzontale vasca-doccia a dischi ceramici, a 3 vie e 3 posizioni.
Horizontal Built-in box for 3-way and 3-positions ceramic disc bath-shower mixer.



Cod. WBOX97D2

INCASSI DOCCIA - SHOWERS BUILT-IN



ATELIER

AL97D2PWB	AL97D2WB
CR	CR
FIN 1	FIN 1
FIN 2	FIN 2

CHRONO

CH97D2PWB	CH97D2WB
CR	CR
FIN 1	FIN 1
FIN 2	FIN 2

CELEBRITY

CEC97D2PWB	CEC97D2WB
CR	CR
FIN 1	FIN 1
FIN 2	FIN 2

ELEMENT

ET97D2PWB	ET97D2WB
CR	CR
FIN 1	FIN 1
FIN 2	FIN 2

Q DESIGN

QD97D2PWB	QD97D2WB
CR	CR
FIN 1	FIN 1
FIN 2	FIN 2

X-STYLE

X97D2PWB	X97D2WB
CR	CR
FIN 1	FIN 1
FIN 2	FIN 2

METRICA

MC97D2PWB	MC97D2WB
CR	CR
FIN 1	FIN 1
FIN 2	FIN 2

ENERGY

EY97D2PWB	EY97D2WB
CR	CR
FIN 1	FIN 1

SLASH

SL97D2PWB	SL97D2WB
CR	CR
FIN 1	FIN 1

DOT

DT97D2PWB	DT97D2WB
CR	CR
FIN 1	FIN 1

ABSOLUTE

AU97D2PWB	AU97D2WB
CR	CR
FIN 1	FIN 1
FIN 2	FIN 2

INFINITY

I97D2PWB	I97D2WB
CR	CR
FIN 1	FIN 1
FIN 2	FIN 2

CLASS LINE

L97D2PWB	L97D2WB
CR	CR
FIN 1	FIN 1

WINNER

W97D2PWB	W97D2WB
CR	CR
FIN 1	FIN 1

BOX INCASSO
BUILT-IN BOX
A PULSANTE
PUSH-BUTTON
TERMOSTATICI
THERMOSTATICS
COLONNE DOCCIA
SHOWER COLUMNS
KIT WELLNESS
WELLNESS KIT
CROMOTERAPIA
COLORTHERAPY
SOFFIONI
SHOWER HEADS
BOCCHE
SPOUTS
PANNELLI DOCCIA
SHOWER PANELS
SALISCENDI
SLIDING RAILS
DOCCETTE
HANDSHOWERS
BORDO VASCA
DECK BATH MIXERS



ATELIER



AL53D2PWB

AL53D2WB

CR
FIN 1
FIN 2

CR
FIN 1
FIN 2

CHRONO



CH53D2PWB

CH53D2WB

CR
FIN 1
FIN 2

CR
FIN 1
FIN 2

CELEBRITY



CEC53D2PWB

CEC53D2WB

CR
FIN 1
FIN 2

CR
FIN 1
FIN 2

ELEMENT



ET53D2PWB

ET53D2WB

CR
FIN 1
FIN 2

CR
FIN 1
FIN 2

Q DESIGN



QD53D2PWB

QD53D2WB

CR
FIN 1
FIN 2

CR
FIN 1
FIN 2

X-STYLE



X53D2PWB

X53D3WB

CR
FIN 1
FIN 2

CR
FIN 1
FIN 2

METRICA



MC53D2PWB

MC53D2WB

CR
FIN 1
FIN 2

CR
FIN 1
FIN 2

ENERGY



EY53D2PWB

EY53D2WB

CR
FIN 1

CR
FIN 1

SLASH



SL53D2PWB

SL53D2WB

CR
FIN 1

CR
FIN 1

DOT



DT53D2PWB

DT53D2WB

CR
FIN 1

CR
FIN 1

ABSOLUTE



AU53D2PWB

AU53D2WB

CR
FIN 1
FIN 2

CR
FIN 1
FIN 2

INFINITY



I53D2PWB

I53D2WB

CR
FIN 1
FIN 2

CR
FIN 1
FIN 2

CLASS LINE



L53D2PWB

L53D2WB

CR
FIN 1

CR
FIN 1

WINNER

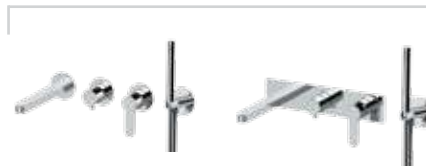

W53D2PWB

W53D2WB

CR
FIN 1

CR
FIN 1

INCASSI VASCA - BATH BUILT-IN



ATELIER



AL54D2PWB

CR
FIN 1
FIN 2



AL54D2WB

CR
FIN 1
FIN 2

CHRONO



CH54D2PWB

CR
FIN 1
FIN 2



CH54D2WB

CR
FIN 1
FIN 2

CELEBRITY



CEC54D2PWB

CR
FIN 1
FIN 2



CEC54D2WB

CR
FIN 1
FIN 2

ELEMENT



ET54D2PWB

CR
FIN 1
FIN 2



ET54D2WB

CR
FIN 1
FIN 2

Q DESIGN



QD54D2PWB

CR
FIN 1
FIN 2



QD54D2WB

CR
FIN 1
FIN 2

X-STYLE



X54D2PWB

CR
FIN 1
FIN 2



X54D2WB

CR
FIN 1
FIN 2

METRICA



MC54D2PWB

CR
FIN 1
FIN 2



MC54D2WB

CR
FIN 1
FIN 2

ENERGY



EY54D2PWB

CR
FIN 1



EY54D2WB

CR
FIN 1

SLASH



SL54D2PWB

CR
FIN 1



SL54D2WB

CR
FIN 1

DOT



DT54D2PWB

CR
FIN 1



DT54D2WB

CR
FIN 1

ABSOLUTE



AU54D2PWB

CR
FIN 1
FIN 2



AU54D2WB

CR
FIN 1
FIN 2

INFINITY



I54D2PWB

CR
FIN 1
FIN 2



I54D2WB

CR
FIN 1
FIN 2

CLASS LINE



L54D2PWB

CR
FIN 1



L54D2WB

CR
FIN 1

WINNER



W54D2PWB

CR
FIN 1



W54D2WB

CR
FIN 1

BOX INCASSO
BUILT-IN BOX
A PULSANTE
PUSH-BUTTON
TERMOSTATICI
THERMOSTATICS
COLONNE DOCCIA
SHOWER COLUMNS
KIT WELLNESS
WELLNESS KIT
CROMOTERAPIA
COLOR THERAPY
SOFFIONI
SHOWER HEADS
BOCCHE
SPOUTS
PANNELLI DOCCIA
SHOWER PANELS
SALISCENDI
SLIDING RAILS
DOCCETTE
HANDSHOWERS
BORDO VASCA
DECK BATH MIXERS

BOX INCASSO BUILT-IN BOXES

PER MISCELATORE ORIZZONTALE VASCA-DOCCIA 3 VIE CON DEVIATORE A DISCHI CERAMICI A 3 POSIZIONI. PRESENTA UNA DELLE DUE USCITE IN LINEA E DEFINITA NELL'INTERASSE.
HORIZONTAL BATH-SHOWER MIXER WITH 3-WAY CERAMIC DISC DIVERTER AND 3 POSITIONS, ENGINEERED WITH ONE OF THE TWO OUTLETS ALIGNED IN THE SAME ROW AS THE MIXER UNIT, MAINTAINING A FIXED AND ACCURATE SPACING.



WBOX97D3

Utilizzando il codice WBOX97D3 - box incasso ORIZZONTALE per miscelatore vasca doccia con deviatore a 3 vie a dischi ceramici e 3 posizioni - possono essere gestite tutte le combinazioni a tre uscite.

Alcune delle possibili combinazioni:

- doccetta + soffione + cascata soffione
- doccetta + soffione + getti
- bocca di erogazione + soffione + cascata
- bocca di erogazione + doccetta + soffione

Le WBOX incasso di Remer Rubinetterie sono realizzate utilizzando i migliori materiali e tecnologie produttive high-tech. La materia prima utilizzata per i WBOX è stata appositamente selezionata per essere pratica al taglio, durevole nel tempo e protettiva.

Grazie alla guarnizione perimetrale di tenuta, le WBOX garantiscono un'impeccabile impermeabilizzazione delle connessioni e delle parti incassate. In caso di anomalie dovute a installazioni o allacciamenti non corretti, l'acqua viene immediatamente segnalata da un trafilemento frontale, evitando qualsiasi infiltrazione all'interno della muratura e offrendo un sistema di sicurezza che permette un intervento tempestivo e mirato.

By using the WBOX97D3 - HORIZONTAL built-in box for bath-shower mixer with 3-way ceramic disc diverter and 3 positions - all three outlets solutions can be combined.

Some of the possible combinations include:

- hand shower + shower head + shower head waterfall
- hand shower + shower head + body jets
- wall mounted spout + shower head + shower head waterfall
- wall mounted spout + hand shower + shower head

The built-in WBOX units from Remer Rubinetterie are produced using the premium materials and high-tech production technologies. The raw material used for WBOX has been specifically selected to be easy to cut, highly durable, and protective.

Thanks to the perimeter sealing gasket, the WBOX ensures exceptional waterproofing of connections and built-in components, providing long-lasting reliability and peace of mind. In the unlikely event of an issue due to incorrect installation or connections, water is promptly and visibly directed to the front, avoiding any risk of infiltration into the wall structure. This innovative safety feature guarantees effortless detection and allows for quick, targeted intervention, ensuring complete confidence in the product's performance and durability.



Box incasso per miscelatore orizzontale vasca-doccia a dischi ceramici, a 3 vie e 3 posizioni.
Horizontal Built-in box for 3-way and 3-positions ceramic disc bath-shower mixer.

3VIE
WAYS

Cod. WBOX97D3

INCASSI DOCCIA - SHOWERS BUILT-IN



ATELIER

AL97D3PWB	AL97D3WB
CR	CR
FIN 1	FIN 1
FIN 2	FIN 2

CHRONO

CH97D3PWB	CH97D3WB
CR	CR
FIN 1	FIN 1
FIN 2	FIN 2

CELEBRITY

CEC97D3PWB	CEC97D3WB
CR	CR
FIN 1	FIN 1
FIN 2	FIN 2

ELEMENT

ET97D3PWB	ET97D3WB
CR	CR
FIN 1	FIN 1
FIN 2	FIN 2

Q DESIGN

QD97D3PWB	QD97D3WB
CR	CR
FIN 1	FIN 1
FIN 2	FIN 2

X-STYLE

X97D3PWB	X97D3WB
CR	CR
FIN 1	FIN 1
FIN 2	FIN 2

METRICA

MC97D3PWB	MC97D3WB
CR	CR
FIN 1	FIN 1
FIN 2	FIN 2

ENERGY

EY97D3PWB	EY97D3WB
CR	CR
FIN 1	FIN 1

SLASH

SL97D3PWB	SL97D3WB
CR	CR
FIN 1	FIN 1

DOT

DT97D3PWB	DT97D3WB
CR	CR
FIN 1	FIN 1

ABSOLUTE

AU97D3PWB	AU97D3WB
CR	CR
FIN 1	FIN 1
FIN 2	FIN 2

INFINITY

I97D3PWB	I97D3WB
CR	CR
FIN 1	FIN 1
FIN 2	FIN 2

CLASS LINE

L97D3PWB	L97D3WB
CR	CR
FIN 1	FIN 1

WINNER

W97D3PWB	W97D3WB
CR	CR
FIN 1	FIN 1

BOX INCASSO
BUILT-IN BOX
A PULSANTE
PUSH-BUTTON
THERMOSTATICI
THERMOSTATICS
COLONNE DOCCIA
SHOWER COLUMNS
KIT WELLNESS
WELLNESS KIT
CROMOTERAPIA
COLOR THERAPY
SOFFIONI
SHOWER HEADS
BOCCHE
SPOUTS
PANNELLI DOCCIA
SHOWER PANELS
SALISCENDI
SLIDING RAILS
DOCCETTE
HANDSHOWERS
BORDO VASCA
DECK BATH MIXERS

INCASSI VASCA - BATH BUILT-IN



ATELIER



AL54D3PWB

CR
FIN 1
FIN 2

AL54D3WB

CR
FIN 1
FIN 2

CHRONO



CH54D3PWB

CR
FIN 1
FIN 2

CH54D3WB

CR
FIN 1
FIN 2

CELEBRITY



CEC54D3PWB

CR
FIN 1
FIN 2

CEC54D3WB

CR
FIN 1
FIN 2

ELEMENT



ET54D3PWB

CR
FIN 1
FIN 2

ET54D3WB

CR
FIN 1
FIN 2

Q DESIGN



QD54D3PWB

CR
FIN 1
FIN 2

QD54D3WB

CR
FIN 1
FIN 2

X-STYLE



X54D3PWB

CR
FIN 1
FIN 2

X54D3WB

CR
FIN 1
FIN 2

METRICA



MC54D3PWB

CR
FIN 1
FIN 2

MC54D3WB

CR
FIN 1
FIN 2

ENERGY



EY54D3PWB

CR
FIN 1

EY54D3WB

CR
FIN 1

SLASH



SL54D3PWB

CR
FIN 1

SL54D3WB

CR
FIN 1

DOT



DT54D3PWB

CR
FIN 1

DT54D3WB

CR
FIN 1

ABSOLUTE



AU54D3PWB

CR
FIN 1
FIN 2

AU54D3WB

CR
FIN 1
FIN 2

INFINITY



I54D3PWB

CR
FIN 1
FIN 2

I54D3WB

CR
FIN 1
FIN 2

CLASS LINE



L54D3PWB

CR
FIN 1

L54D3WB

CR
FIN 1

WINNER



W54D3PWB

CR
FIN 1

W54D3WB

CR
FIN 1



AI54D3WB

WELLNESS

BORDO VASCA
DECK BATH MIXERS

DOCCHETTE
HANDSHOWERS

SALISCENDI
SLIDING RAILS

PANNELLI DOCCIA
SHOWER PANELS

BOCCHE
SPOUTS

SOFFIONI
SHOWER HEADS

CROMOTERAPIA
COLOR THERAPY

KIT WELLNESS
WELLNESS KIT

COLONNE DOCCIA
SHOWER COLUMNS

TERMOSTATICI
THERMOSTATICS

A PULSANTE
PUSH-BUTTON

BOX INCASSO
BUILT-IN BOX

BOX INCASSO BUILT-IN BOXES

PER MISCELATORE INCASSO VASCA-DOCCIA CON CARTUCCIA PROGRESSIVA E VITONI CERAMICI APRI/CHIUDI PER COMANDARE FINO A 5 SINGOLE USCITE.

FOR BUILT-IN BATH-SHOWER MIXERS WITH A PROGRESSIVE CARTRIDGE AND CERAMIC DISC TURN ON/OFF VALVES TO CONTROL TIL 5 INDIVIDUAL OUTLETS.



Utilizzando il codice WBOX98D - box incasso ORIZZONTALE / VERTICALE per miscelatore vasca doccia con cartuccia progressiva e vitoni a dischi ceramici apri/chiudi per comandare le singole uscite - è possibile gestire tutte le combinazioni da 2 a 5 uscite in base alla declinazione del prodotto selezionata.

Il medesimo prodotto può essere installato in orizzontale o verticale a scelta dell'utente. I selettori a vitone rendono il design molto ricercato.

Le WBOX incasso di Remer Rubinetterie sono realizzate utilizzando i migliori materiali e tecnologie produttive high-tech. La materia prima utilizzata per i WBOX è stata appositamente selezionata per essere pratica al taglio, durevole nel tempo e protettiva.

Grazie alla guarnizione perimetrale di tenuta, le WBOX garantiscono un'impeccabile impermeabilizzazione delle connessioni e delle parti incassate. In caso di anomalie dovute a installazioni o allacciamenti non corretti, l'acqua viene immediatamente segnalata da un trafilemento frontale, evitando qualsiasi infiltrazione all'interno della muratura e offrendo un sistema di sicurezza che permette un intervento tempestivo e mirato.

Using the WBOX98D - a built-in box for HORIZONTAL/VERTICAL bath-shower mixers with a progressive cartridge and ceramic disc turn on/off valves to manage individual outlets - you can configure all combinations from 2 to 5 outlets, depending on the selected product variation.

The same product can be installed either horizontally or vertically, based on user's preference. The ceramic disc selectors enhance the design, giving it a refined and sophisticated look.

The built-in WBOX units from Remer Rubinetterie are produced using the premium materials and high-tech production technologies. The raw material used for WBOX has been specifically selected to be easy to cut, highly durable, and protective.

Thanks to the perimeter sealing gasket, the WBOX ensures exceptional waterproofing of connections and built-in components, providing long-lasting reliability and peace of mind. In the unlikely event of an issue due to incorrect installation or connections, water is promptly and visibly directed to the front, avoiding any risk of infiltration into the wall structure. This innovative safety feature guarantees effortless detection and allows for quick, targeted intervention, ensuring complete confidence in the product's performance and durability.

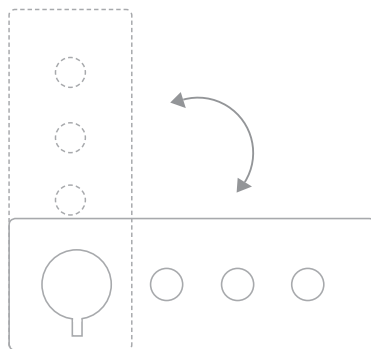

CON PIASTRA RETTANGOLARE
WITH RECTANGULAR PLATE

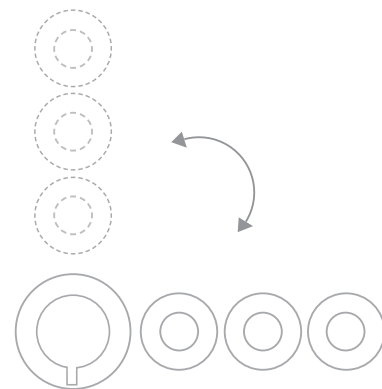

CON PIASTRE TONDE SEPARATE
WITH SEPARATE ROUND PLATES



2 VIE
WAYS

X-STYLE

CHRONO



N98D2WB

N98D2PWB

CH98D2WB

CH98D2PWB

CR
FIN 1
FIN 2

CR
FIN 1
FIN 2

CR
FIN 1
FIN 2

CR
FIN 1
FIN 2



3 VIE
WAYS

X-STYLE

CHRONO



N98D3WB

N98D3PWB

CH98D3WB

CH98D3PWB

CR
FIN 1
FIN 2

CR
FIN 1
FIN 2

CR
FIN 1
FIN 2

CR
FIN 1
FIN 2

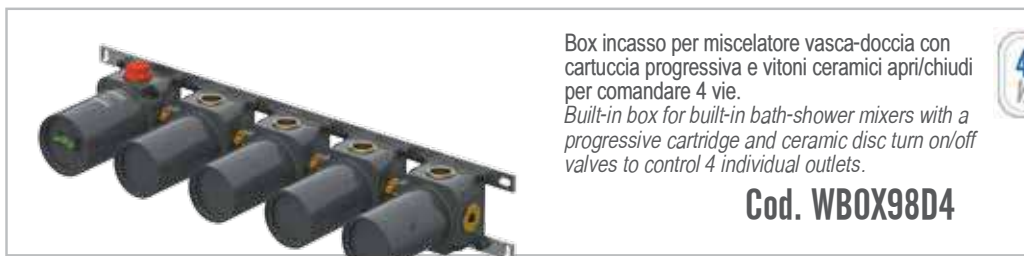

Box incasso per miscelatore vasca-doccia con cartuccia progressiva e vitoni ceramici apri/chiodi per comandare 4 vie.
Built-in box for built-in bath-shower mixers with a progressive cartridge and ceramic disc turn on/off valves to control 4 individual outlets.



Cod. WBOX98D4

X-STYLE



N98D4WB

N98D4PWB

CR
FIN 1
FIN 2

CR
FIN 1
FIN 2

CHRONO



CH98D4WB

CH98D4PWB

CR
FIN 1
FIN 2

CR
FIN 1
FIN 2

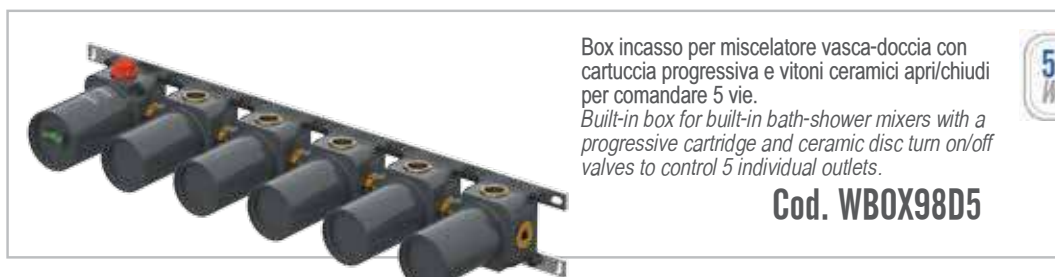

Box incasso per miscelatore vasca-doccia con cartuccia progressiva e vitoni ceramici apri/chiodi per comandare 5 vie.
Built-in box for built-in bath-shower mixers with a progressive cartridge and ceramic disc turn on/off valves to control 5 individual outlets.



Cod. WBOX98D5

X-STYLE



N98D5WB

N98D5PWB

CR
FIN 1
FIN 2

CR
FIN 1
FIN 2

CHRONO



CH98D5WB

CH98D5PWB

CR
FIN 1
FIN 2

CR
FIN 1
FIN 2



N98D3WBNO

BORDO VASCA
DECK BATH MIXERS

DOCCHETTE
HANDSHOWERS

SALISCENDI
SLIDING RAILS

PANNELLI DOCCIA
SHOWER PANELS

BOCCHE
SPOUTS

SOFFIONI
SHOWER HEADS

CROMOTERAPIA
COLOR THERAPY

KIT WELLNESS
WELLNESS KIT

COLONNE DOCCIA
SHOWER COLUMNS

TERMOSTATICI
THERMOSTATICS

A PULSANTE
PUSH-BUTTON

BOX INCASSO
BUILT-IN BOX

TERMOSTATICI A PULSANTE - PUSH-BUTTON THERMOSTATICS

TERMOSTATICI A PULSANTE PUSH-BUTTON THERMOSTATICS



THERMOBOX e THERMOSET, innovative soluzioni termostatiche ad incasso con singola box o box in linea per la gestione da una a cinque vie azionate da pulsanti ON/OFF.

THERMOBOX and THERMOSET, innovative built-in thermostatic solutions with single boxe or in-line boxes for managing one to five outlets operated by ON/OFF buttons.



**BOX INCASSO
THERMOBOX
BUILT-IN
THERMOBOXES**

BOX INCASSO PER MISCELATORE TERMOSTATICO AD ALTA PORTATA, CON PULSANTI ON/OFF PER APERTURA E CHIUSURA DELLE SINGOLE USCITE. DISPONIBILE IN VERSIONE 2 O 3 VIE/ PULSANTI

BUILT-IN BOX FOR HIGH-FLOW THERMOSTATIC MIXER WITH ON/OFF BUTTONS FOR OPENING AND CLOSING INDIVIDUAL OUTLETS. AVAILABLE IN 2 OR 3 WAY/BUTTON VERSIONS



Questa BOX ad alta portata nasce per unire l'utilità del sistema termostatico con la praticità della selezione delle singole uscite tramite due o tre pulsanti on/off, a seconda del modello scelto.

La nostra ThermoBOX garantisce inoltre una comoda installazione e manutenzione nonché una maggiore tenuta in caso di anomalie dovute ad installazioni o allacciamenti non corretti.

Al suo interno troviamo un sistema completo che incorpora anche due valvole di non ritorno dotate di prefiltri, per rendere ancora più sicuro e confortevole sia l'utilizzo che la manutenzione.

E' un sistema di grande impatto visivo per una scelta di design e modernità.

Anche questo termostatico e' dotato di pulsante di fermo e sicurezza tarato sui 38 gradi Celsius.

This high-flow box combines the functionality of a thermostatic system with the convenience of selecting individual outlets via two or three on/off buttons, depending on the chosen model.

Our ThermoBOX also ensures easy installation and maintenance, as well as improved reliability in the event of anomalies caused by incorrect installations or connections.

Inside, the system includes two non-return valves with integrated pre-filters, enhancing both safety and convenience during use and maintenance.

This is a visually striking system, ideal for those seeking a modern and design-oriented solution.

Additionally, this thermostatic system features a safety stop button pre-set to 38 degrees Celsius.

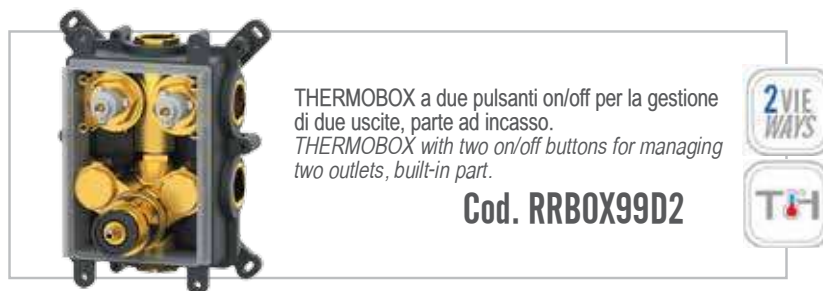

INCASSI CON RRBOX99D2 - BUILT-IN WITH RRBOX99D2



X99QD2KB

Parte esterna THERMOBOX a due vie/ due pulsanti, con piastra quadrata ed impugnatura tonda.

External part for THERMOBOX, two-way/two-buttons, with squared plate and round handle.

CR



X99D2KB

Parte esterna THERMOBOX a due vie / due pulsanti, con piastra tonda ed impugnatura tonda.

External part for THERMOBOX, two-way/two-buttons, with round plate and round handle.

CR



AU99D2KB

Parte esterna THERMOBOX a due vie/ due pulsanti, con piastra quadrata ed impugnatura quadrata.

External part for THERMOBOX, two-way/two-buttons, with squared plate and squared handle.

CR

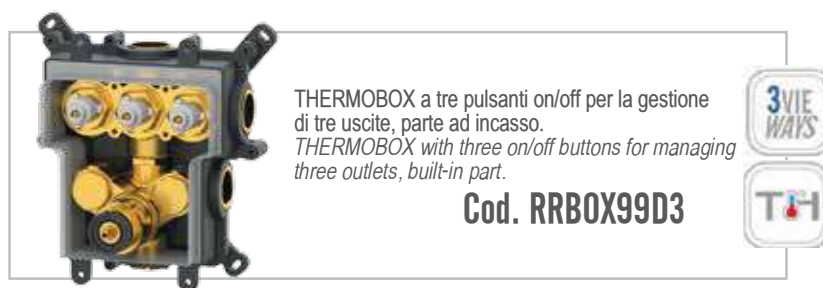

INCASSI CON RRBOX99D3 - BUILT-IN WITH RRBOX99D3



X99QD3KB

Parte esterna THERMOBOX a tre vie/ tre pulsanti, con piastra quadrata ed impugnatura tonda.

External part for THERMOBOX, three-way/three-button, with squared plate and round handle.

CR



AU99D3KB

Parte esterna THERMOBOX a tre vie/ tre pulsanti, con piastra quadrata ed impugnatura quadrata.

External part for THERMOBOX, three-way/three-button, with squared plate and squared handle.

CR

**BOX INCASSO
THERMOSET
BUILT-IN
THERMOSET
BOXES**

BOX INCASSO PER MISCELATORE TERMOSTATICO AD ALTA PORTATA, VERSIONE IN LINEA, CON PULSANTI ON/OFF PER APERTURA E CHIUSURA DELLE SINGOLE USCITE. DISPONIBILE IN VERSIONE 2 O 3 VIE / PULSANTI

BUILT-IN BOX FOR HIGH-FLOW THERMOSTATIC MIXER, IN-LINE VERSION, WITH ON/OFF BUTTONS FOR OPENING AND CLOSING INDIVIDUAL OUTLETS. AVAILABLE IN 2 OR 3 WAY/BUTTON VERSIONS



Questo set termostatico, disponibile in configurazioni da tre o quattro elementi a seconda del numero di uscite prescelto, è composto da singole box inserite in un unico sistema e progettate per essere installate in linea. Il sistema THERMOSET è studiato per garantire un perfetto allineamento e facilitare l'installazione, offrendo un risultato preciso e funzionale.

Questo sistema a singole box garantisce inoltre una comoda installazione e manutenzione nonché una maggiore tenuta in caso di anomalie dovute ad installazioni o allacciamenti non corretti.

E' un sistema di grande impatto visivo per una scelta di design e modernità.

Anche questo termostatico e' dotato di pulsante di fermo e sicurezza tarato sui 38 gradi.

This thermostatic set, available in configurations of three or four elements depending on the selected number of outlets, consists of individual boxes integrated into a single system and designed for in-line installation. The THERMOSET system is engineered to ensure perfect alignment and simplify installation, delivering a precise and functional result.

This single-box system also ensures convenient installation and maintenance, as well as enhanced reliability in the event of anomalies caused by incorrect installations or connections.

It is a visually striking system, perfect for those seeking a modern and design-focused solution.

Additionally, this thermostatic system features a safety stop button pre-set to 38 degrees Celsius.



THERMOSET in linea, per sistemi a due vie, con due pulsanti, parti ad incasso.
In-line THERMOSET for two-way systems, with two buttons, built-in parts

Cod. RRBOX99D2P



PARTI ESTERNE PER THERMOSET COD. RRBOX99D2P
EXTERNAL PARTS FOR THERMOSET COD. RRBOX99D2P



X99QD2PKB

Parti esterne per Thermostat a due vie e due pulsanti, piastre singole squadrate e maniglia tonda.

External parts for Thermostat, two-way and two-buttons, single squared plates and round handle.

CR



X99D2PKB

Parti esterne per Thermostat a due vie e due pulsanti, piastre singole tonde e maniglia tonda.

External parts for Thermostat, two-way and two-buttons, single round plates and round handle.

CR



AU99D2PKB

Parti esterne per Thermostat a due vie e due pulsanti, piastre singole squadrate e maniglia quadra.

External parts for Thermostat, two-way and two-buttons, single squared plates and squared handle.

CR



THERMOSET in linea, per sistemi a tre vie, con tre pulsanti, parti ad incasso.
In-line THERMOSET for three-way systems, with three buttons, built-in parts.

Cod. RRBOX99D3P



PARTI ESTERNE PER THERMOSET COD. RRBOX99D3P
EXTERNAL PARTS FOR THERMOSET COD. RRBOX99D3P



X99QD3PKB

Parti esterne per Thermostat a tre vie e tre pulsanti, piastre singole squadrate e maniglia tonda.

External parts for Thermostat, three-way and three-buttons, single squared plates and round handle.

CR



X99D3PKB

Parti esterne per Thermostat a tre vie e tre pulsanti, piastre singole tonde e maniglia tonda.

External parts for Thermostat, three-way and three-buttons, single round plates and round handle.

CR



AU99D3PKB

Parti esterne per Thermostat a tre vie e tre pulsanti, piastre singole squadrate e maniglia quadra.

External parts for Thermostat, three-way and three-buttons, single squared plates and squared handle.

CR



TERMOSTATICI - THERMOSTATICS

TERMOSTATICI THERMOSTATICS



I miscelatori termostatici sono dispositivi progettati per mantenere una temperatura costante dell'acqua, offrendo un controllo preciso e sicuro durante l'uso. Questi miscelatori sono particolarmente apprezzati per la loro capacità di moderare sbalzi di temperatura improvvisi, garantendo un'esperienza confortevole e riducendo il rischio di scottature.

Thermostatic mixers are devices designed to maintain a constant water temperature, providing precise and safe control during use. These mixers are particularly appreciated for their ability to moderate sudden temperature fluctuations, ensuring a comfortable experience and reducing the risk of scalding.



INCASSI TERMOSTATICI TONDI THERMOSTATICS ROUND BUILT-IN



INCASSI TERMOSTATICI - THERMOSTATIC BUILT-IN MIXERS



NT30

Miscelatore termostatico da incasso per doccia completo, senza deviatore.
Complete thermostatic built-in mixer for shower, without diverter.

CR



NT09

Miscelatore termostatico da incasso completo con deviatore per vasca-doccia.
Complete thermostatic built-in single-lever mixer, with diverter for bath-shower.

CR

NT30B

Solo parte interna.
Built-in components only.

CR

NT30E

Solo parte esterna.
Exposed components only.

CR

NT09B

Solo parte interna.
Built-in components only.

CR



NT09E

Solo parte esterna.
Exposed components only.

CR



NT92
NT93



NT94
NT95

NT92

Miscelatore termostatico per doccia con deviatore a 2 vie (1 entrata e 2 uscite).
Thermostatic built-in shower mixer with 2 ways diverter (1 inlet and 2 outlets).

CR



NT93

Miscelatore termostatico per doccia con deviatore a 3 vie (1 entrata e 3 uscite).
Thermostatic built-in shower mixer with 3 ways diverter (1 inlet and 3 outlets).

CR



NT94

Miscelatore termostatico per doccia con deviatore a 4 vie (1 entrata e 4 uscite).
Thermostatic built-in shower mixer with 4 ways diverter (1 inlet and 4 outlets).

CR



NT95

Miscelatore termostatico per doccia con deviatore a 5 vie (1 entrata e 5 uscite).
Thermostatic built-in shower mixer with 5 ways diverter (1 inlet and 5 outlets).

CR



NT92Q
NT93Q



NT94Q
NT95Q

NT92Q

Miscelatore termostatico per doccia con deviatore a 2 vie (1 entrata e 2 uscite).
Thermostatic built-in shower mixer with 2 ways diverter (1 inlet and 2 outlets).

CR



NT93Q

Miscelatore termostatico per doccia con deviatore a 3 vie (1 entrata e 3 uscite).
Thermostatic built-in shower mixer with 3 ways diverter (1 inlet and 3 outlets).

CR



NT94Q

Miscelatore termostatico per doccia con deviatore a 4 vie (1 entrata e 4 uscite).
Thermostatic built-in shower mixer with 4 ways diverter (1 inlet and 4 outlets).

CR



NT95Q

Miscelatore termostatico per doccia con deviatore a 5 vie (1 entrata e 5 uscite).
Thermostatic built-in shower mixer with 5 ways diverter (1 inlet and 5 outlets).

CR



**NT94C**

Miscelatore termostatico per doccia, con deviatore a 4 posizioni (4 uscite ed 1 entrata), con possibilità di chiusura del flusso dal deviatore durante il cambio di posizione.

Thermostatic shower mixer with 4 positions diverter (4 outlets and 1 inlet), with the possibility of closing the flow from the diverter during the position change.

CR

**NT95C**

Miscelatore termostatico per doccia, con deviatore a 5 posizioni (5 uscite ed 1 entrata), con possibilità di chiusura del flusso dal deviatore durante il cambio di posizione.

Thermostatic shower mixer with 5 positions diverter (5 outlets and 1 inlet), with the possibility of closing the flow from the diverter during the position change.

CR

**NT60W**

Miscelatore incasso per shut-off comprensivo di: doccetta shut-off, supporto doccia- presa acqua su piastra in ottone e flessibile doccia cm 120.

Built-in shut-off mixer set including: shut.off, shower holder water punch on flange, all in brass and shower flexible cm 120.

CR

BOX INCASSO - BUILT-IN BOX MIXERS**RRBOX**

Box da incasso per miscelatore doccia con deviatore.

Built-in box for shower mixer with diverter.

CR

+

**NT30KB**

Set miscelatore doccia termostatico da abbinare al box incasso.

Thermostatic shower mixer set to match with the built-in box.

CR

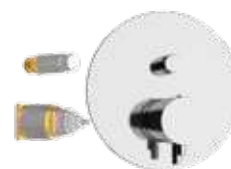
OPPURE
OR**NT09KB**

Set miscelatore doccia termostatico con deviatore da abbinare al box incasso.

Thermostatic shower mixer set with diverter to match with the built-in box

CR

**RRBOX92**

Box da incasso per miscelatore doccia due vie.

Built-in box for two ways shower mixer.

CR

+

**NT92KB**

Set miscelatore doccia termostatico due vie da abbinare al box incasso.

Thermostatic two ways shower mixer set to match with the built-in box.

CR

**RRBOX93**

Box da incasso per miscelatore doccia tre vie.

Built-in box for three ways shower mixer.

CR

+

**NT93KB**

Set miscelatore doccia termostatico tre vie da abbinare al box incasso.

Thermostatic three ways shower mixer set to match with the built-in box.

CR

INCASSI TERMOSTATICI QUADRATI THERMOSTATICS SQUARED BUILT-IN



INCASSI TERMOSTATICI - THERMOSTATIC BUILT-IN MIXERS



QT30

Miscelatore termostatico da incasso per doccia completo, senza deviatore.
Complete thermostatic built-in mixer for shower, without diverter.

CR



QT09

Miscelatore termostatico da incasso completo con deviatore per vasca-doccia.
Complete thermostatic built-in single-lever mixer, with diverter for bath-shower.

CR

NT30B

Solo parte interna.
Built-in components only.

CR

QT30E

Solo parte esterna.
Exposed components only.

CR

NT09B

Solo parte interna.
Built-in components only.

CR



QT09E

Solo parte esterna.
Exposed components only.

CR



QT92
QT93



QT94
QT95

QT92

Miscelatore termostatico per doccia con deviatore a 2 vie (1 entrata e 2 uscite).
Thermostatic built-in shower mixer with 2 ways diverter (1 inlet and 2 outlets).

CR



QT93

Miscelatore termostatico per doccia con deviatore a 3 vie (1 entrata e 3 uscite).
Thermostatic built-in shower mixer with 3 ways diverter (1 inlet and 3 outlets).

CR



QT94

Miscelatore termostatico per doccia con deviatore a 4 vie (1 entrata e 4 uscite).
Thermostatic built-in shower mixer with 4 ways diverter (1 inlet and 4 outlets).

CR



QT95

Miscelatore termostatico per doccia con deviatore a 5 vie (1 entrata e 5 uscite).
Thermostatic built-in shower mixer with 5 ways diverter (1 inlet and 5 outlets).

CR



**QT94C**

Miscelatore termostatico per doccia, con deviatore a 4 posizioni (4 uscite ed 1 entrata) su doppia piastra, con possibilità di chiusura del flusso dal deviatore durante il cambio di posizione.

Thermostatic shower mixer with 4 positions diverter (4 outlets and 1 inlet) on double flange, with the possibility of closing the flow from the diverter during the position change.

CR

**QT95C**

Miscelatore termostatico per doccia, con deviatore a 5 posizioni (5 uscite ed una entrata) su doppia piastra, con possibilità di chiusura del flusso dal deviatore durante il cambio di posizione.

Thermostatic shower mixer with 5 positions diverter (5 outlets and 1 inlet) on double flange, with the possibility of closing the flow from the diverter during the position change.

CR

BOX INCASSO - BUILT-IN BOX MIXERS**RRBOX**

Box da incasso per miscelatore doccia con deviatore.

Built-in box for shower mixer with diverter.

CR

+

**QT30KB**

Set miscelatore doccia termostatico da abbinare al box incasso.

Thermostatic shower mixer set to match with the built-in box.

CR

OPPURE
OR**QT09KB**

Set miscelatore doccia termostatico con deviatore da abbinare al box incasso.

Thermostatic shower mixer set with diverter to match with the built-in box.

CR

**RRBOX92**

Box da incasso per miscelatore doccia due vie.

Built-in box for two ways shower mixer.

CR

+

**QT92KB**

Set miscelatore doccia termostatico due vie da abbinare al box incasso.

Thermostatic two ways shower mixer set to match with the built-in box.

CR

**RRBOX93**

Box da incasso per miscelatore doccia tre vie.

Built-in box for three ways shower mixer.

CR

+

**QT93KB**

Set miscelatore doccia termostatico tre vie da abbinare al box incasso.

Thermostatic three ways shower mixer set to match with the built-in box.

CR

SET DOCCIA TERMOSTATICI TONDI

THERMOSTATICS ROUND SHOWER SETS



KIT WELLNESS TERMOSTATICI TONDI

ROUND THERMOSTATIC WELLNESS KIT

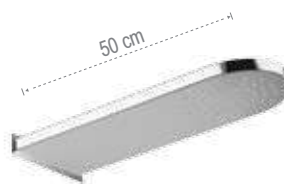

Set doccia composto da: miscelatore termostatico a incasso con deviatore, soffione in acciaio inox 357UFM20X, braccio in ottone 30 cm, presa acqua a muro con supporto doccetta, doccetta in abs, 1 funzione 317MD, flessibile 150 cm.

Shower set including: thermostatic built-in mixer with diverter, stainless steel Ø 20cm shower head 357UFM20X, brass arm 30 cm, wall water connection with shower holder, 1-function abs hand shower 317MD, 150 cm flexible hose.



NT09S027MDMM

Set doccia composto da: miscelatore termostatico a incasso con deviatore, soffione a parete in acciaio inox con getto a pioggia 350MMX, presa acqua a muro con supporto doccetta, doccetta in abs, 1 funzione 317MD, flessibile 150 cm.

Shower set including: thermostatic built-in mixer with diverter, wall-mounted stainless steel shower head with rain jet 350MMX, wall water connection with shower holder, 1-function abs hand shower 317MD, 150 cm flexible hose.



NT09S02UFM20

con soffione da Ø20 cm e braccio a parete 30 cm.
with shower head Ø20 cm and wall arm 30 cm.

CR



NT09S02UFM25

con soffione da Ø25 cm e braccio a parete 30 cm.
with shower head Ø25 cm and wall arm 30 cm.

CR

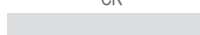

NT09S02UFM30

con soffione da Ø30 cm e braccio a parete 30 cm.
with shower head Ø30 cm and wall arm 30 cm.

CR

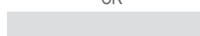

CR



SET DOCCIA TERMOSTATICI QUADRATI

THERMOSTATICS SQUARED SHOWER SETS



KIT WELLNESS TERMOSTATICI QUADRATI

SQUARED THERMOSTATIC WELLNESS KIT



Set doccia composto da: miscelatore termostatico a incasso con deviatore, soffione in acciaio inox 357UFS20X, braccio quadrato in ottone 30 cm, presa acqua a muro con supporto doccetta, doccetta quadrata in ABS, 1 funzione 317SD, flessibile 150 cm.

Shower set including: thermostatic built-in mixer with diverter, stainless steel 20x20cm shower head 357UFS20X, square brass arm 30 cm, wall water connection with shower holder, 1-function abs square hand shower 317SD, 150 cm flexible hose.



QT09S02UFS20

con soffione da 20x20 cm e braccio a parete 30 cm.
with shower head 20x20 cm and wall arm 30 cm.

CR

QT09S02UFS25

con soffione da 25x25 cm e braccio a parete 30 cm.
with shower head 25x25 cm and wall arm 30 cm.

CR

QT09S02UFS30

con soffione da 30x30 cm e braccio a parete 30 cm.
with shower head 30x30 cm and wall arm 30 cm.

CR



QT09S027SDQSS

Set doccia composto da: miscelatore termostatico a incasso con deviatore, soffione a parete in acciaio inox con getto a pioggia 350SSX, presa acqua a muro con supporto doccetta, doccetta quadrata in ABS, 1 funzione 317SD, flessibile 150 cm.

Shower set including: thermostatic built-in mixer with diverter, wall-mounted stainless steel shower head with rain jet 350SSX, wall water connection with shower holder, 1-function abs square hand shower 317SD, 150 cm flexible hose..



CR

MISCELATORI TERMOSTATICI ESTERNI THERMOSTATICS EXPOSED MIXERS



EQ32

Miscelatore esterno doccia termostatico con deviatore integrato, attacco alto da 1/2" ed attacco inferiore da 1/2".

Thermostatic shower mixer with integrated diverter, upper 1/2" connection and lower 1/2" connection.

CR



EQ3234

Miscelatore esterno doccia termostatico con deviatore integrato, attacco alto 3/4" ed attacco inferiore da 1/2".

Thermostatic shower mixer with integrated diverter, upper 3/4" connection and lower 1/2" connection.

CR



EQ34

Miscelatore esterno doccia termostatico a 3 vie, con attacco superiore da 3/4" inferiore da 1/2".

Thermostatic 3-ways exposed shower mixer, with upper 3/4" connection and lower 1/2" connection.

CR



EQ32L

Miscelatore esterno doccia termostatico con deviatore integrato, attacco alto da 1/2" ed attacco inferiore da 1/2", maniglie in ottone.

Thermostatic shower mixer with integrated diverter, upper 1/2" connection and lower 1/2" connection, handles in brass.

CR



EQ3234L

Miscelatore esterno doccia termostatico con deviatore integrato, attacco alto 3/4" ed attacco inferiore da 1/2", maniglie in ottone.

Thermostatic shower mixer with integrated diverter, upper 3/4" connection and lower 1/2" connection, handles in brass.

CR



EQ34L

Miscelatore esterno doccia termostatico a 3 vie, con attacco superiore da 3/4" inferiore da 1/2", maniglie in ottone.

Thermostatic 3-ways exposed shower mixer, with upper 3/4" connection and lower 1/2" connection, handles in brass.

CR

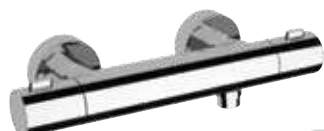

EQ31

Miscelatore esterno doccia termostatico con attacco inferiore da 1/2".

Thermostatic shower mixer, with lower 1/2" connection.

CR

**EQ02**

Miscelatore termostatico esterno vasca con deviatore integrato, con doccetta in ABS anticalcare ad 1 funzione e supporto snodato flessibile 150 cm.

Thermostatic bath mixer with integrated diverter, with 1 function antilimescale ABS handshower and swivel shower holder, flexible hose 150 cm.

CR

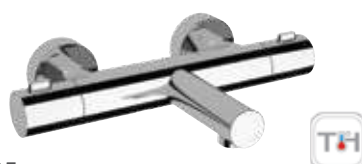
**EQ05**

Miscelatore termostatico esterno vasca con deviatore integrato, senza kit doccia.

Thermostatic bath mixer with integrated diverter, without shower kit.

CR

**ST32L**

Miscelatore esterno doccia termostatico, forma quadrata, con deviatore incorporato ed attacco alto da 3/4" ed attacco inferiore da 1/2", maniglie in ottone.

Thermostatic shower mixer, squared shape, with integrated diverter, upper 3/4" connection and lower 1/2" connection, handles in brass.

CR

**ST32**

Miscelatore esterno doccia termostatico, forma quadrata, con deviatore incorporato ed attacco alto da 3/4" ed attacco inferiore da 1/2", maniglie in ABS.

Thermostatic shower mixer, squared shape, with integrated diverter, upper 3/4" connection and lower 1/2" connection, handles in ABS.

CR



COLONNE VASCA TERMOSTATICHE THERMOSTATICS BATH COLUMNS



min. 103 cm - max. 157 cm
95 cm

Set doccia composto da: miscelatore termostatico esterno con deviatore vasca/doccia, soffione in abs 356MD20X, colonna doccia in ottone telescopica, altezza asta regolabile 329A, doccetta in abs, 1 funzione 317MD, flessibile 150 cm.
Shower set including: exposed thermostatic mixer with bath/shower diverter, abs shower head 356MD20X, telescopic brass shower column, with height-adjustable rod 329A, 1-function abs hand shower 317MD, 150 cm flexible hose.

EQ34A7MDMD20 Soffione Ø 20 cm. Shower head Ø 20 cm.	CR	<input type="checkbox"/>
EQ34A7MDMD25 Soffione Ø 25 cm. Shower head Ø 25 cm.	CR	<input type="checkbox"/>
EQ34A7MDMD30 Soffione Ø 30 cm. Shower head Ø 30 cm.	CR	<input type="checkbox"/>



min. 103 cm - max. 157 cm
95 cm

Set doccia composto da: miscelatore termostatico esterno con deviatore vasca/doccia, soffione in abs 356SD20X, colonna doccia in ottone telescopica, altezza asta regolabile 329A, doccetta quadrata in ABS, 1 funzione 317SD, flessibile 150 cm.
Shower set including: exposed thermostatic mixer with bath/shower diverter, abs shower head 356SD20X, telescopic brass shower column, with height-adjustable rod 329A, 1-function abs square hand shower 317SD, 150 cm flexible hose.

EQ34A7SDSD20 Soffione 20x20 cm. Shower head 20x20 cm.	CR	<input type="checkbox"/>
EQ34A7SDSD25 Soffione 25x25 cm. Shower head 25x25 cm.	CR	<input type="checkbox"/>
EQ34A7SDSD30 Soffione 30x30 cm. Shower head 30x30 cm.	CR	<input type="checkbox"/>



min. 103 cm - max. 157 cm
95 cm

Set doccia composto da: miscelatore termostatico esterno con deviatore vasca/doccia, soffione in acciaio inox 357UFM20X, colonna doccia in ottone telescopica, altezza asta regolabile 329A, doccetta in abs con 3 funzioni 318MP, flessibile 150 cm.
Shower set including: exposed thermostatic mixer with bath/shower diverter, stainless steel shower head 357UFM20X, telescopic brass shower column, with height-adjustable rod 329A, 3-function abs hand shower 318MP, 150 cm flexible hose.

EQ34A8MPUFM20 Soffione Ø 20 cm. Shower head Ø 20 cm.	CR	NO	<input type="checkbox"/>
EQ34A8MPUFM25 Soffione Ø 25 cm. Shower head Ø 25 cm.	CR	NO	<input type="checkbox"/>
EQ34A8MPUFM30 Soffione Ø 30 cm. Shower head Ø 30 cm.	CR	NO	<input type="checkbox"/>

min. 103 cm - max. 157 cm
95 cm

Set doccia composto da: miscelatore termostatico esterno con deviatore vasca/doccia, soffione quadrato ultrapiatto in acciaio inox lucidato a specchio 357UFS20X, colonna doccia in ottone telescopica con altezza asta regolabile e deviatore 329°, doccetta in abs cromato, 3 funzioni 318CP, flessibile 150 cm.
Shower set including: exposed thermostatic mixer with bath/shower diverter, ultra-flat square shower head in mirror polished stainless steel 357UFS20X, telescopic brass shower column with height-adjustable rod and diverter 329°, 3-function c.p. abs handshower 318CP, 150 cm flexible hose.

EQ34A8CPUFS20 Soffione 20x20 cm. Shower head 20x20 cm.	CR	NO	<input type="checkbox"/>
EQ34A8CPUFS25 Soffione 25x25 cm. Shower head 25x25 cm.	CR	NO	<input type="checkbox"/>
EQ34A8CPUFS30 Soffione 30x30 cm. Shower head 30x30 cm.	CR	NO	<input type="checkbox"/>





EQ34A7MDMD20

BORDO VASCA
DECK BATH MIXERS

DOCCHETTE
HANDSHOWERS

SALISCENDI
SLIDING RAILS

PANNELLI DOCCIA
SHOWER PANELS

BOCCHE
SPOUTS

SOFFIONI
SHOWER HEADS

CROMOTERAPIA
COLORTHERAPY

KIT WELLNESS
WELLNESS KIT

COLONNE DOCCIA
SHOWER COLUMNS

TERMOSTATICI
THERMOSTATICS

A PULSANTE
PUSH-BUTTON

BOX INCASSO
BUILT-IN BOX

COLONNE DOCCIA TERMOSTATICHE TONDE THERMOSTATICS ROUND SHOWER COLUMNS

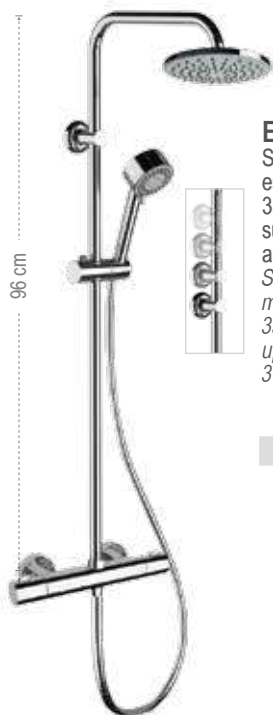

EQ32XEC20

Set doccia composto da: miscelatore termostatico esterno con deviatore, soffione in abs Ø 20cm 354EC20X, colonna doccia con fissaggio superiore regolabile in altezza 329X, doccetta in abs a 3 funzioni 319MO, flessibile 150 cm.

Shower set including: exposed thermostatic mixer with diverter, abs Ø 20 cm shower head 354EC20X, shower column with height-adjustable upper fixing 329X, 3-function abs hand shower 319MO, 150 cm flexible hose.

CR

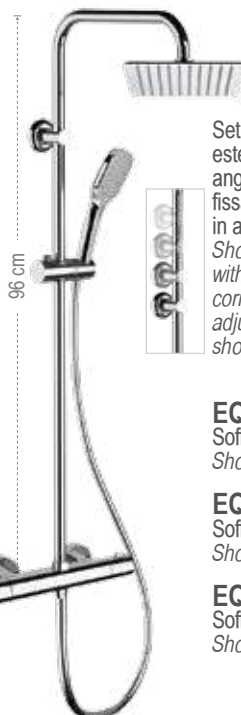

Set doccia composto da: miscelatore termostatico esterno con deviatore, soffione in acciaio inox con angoli arrotondati 357UFD20X, colonna doccia con fissaggio superiore regolabile in altezza 329X, doccetta in abs con 3 funzioni 318CP, flessibile 150 cm.

Shower set including: exposed thermostatic mixer with diverter, stainless steel shower head with rounded corners 357UFD20X, shower column with height-adjustable upper fixing 329X, 3-function abs hand shower 318CP, 150 cm flexible hose.

EQ32X8CPUFD20

Soffione 20x20 cm.
Shower head 20x20 cm.

CR NO

EQ32X8CPUFD25

Soffione 25x25 cm.
Shower head 25x25 cm.

CR NO

EQ32X8CPUFD30

Soffione 30x30 cm.
Shower head 30x30 cm.

CR NO



Set doccia composto da: miscelatore termostatico esterno con deviatore, soffione in acciaio inox 357UFM20X, colonna doccia con fissaggio superiore regolabile in altezza 329X, doccetta in abs a 3 funzioni 319MO, flessibile 150 cm.

Shower set including: exposed thermostatic mixer with diverter, stainless steel shower head 357UFM20X, shower column with height-adjustable upper fixing 329X, 3-function abs hand shower 319MO, 150 cm flexible hose.

EQ32XUFM20

Soffione Ø 20 cm.
Shower head Ø 20 cm.

CR

EQ32XUFM25

Soffione Ø 25 cm.
Shower head Ø 25 cm.

CR

EQ32XUFM30

Soffione Ø 30 cm.
Shower head Ø 30 cm.

CR



Set doccia composto da: miscelatore termostatico esterno con deviatore, soffione in abs 356MD20X, colonna doccia con fissaggio superiore regolabile in altezza 329X, doccetta in abs con 3 funzioni 318MP, flessibile 150 cm.

Shower set including: exposed thermostatic mixer with diverter, abs shower head 356MD20X, shower column with height-adjustable upper fixing 329X, 3-function abs hand shower 318MP, 150 cm flexible hose.

EQ32X8MPMD20

Soffione Ø 20 cm.
Shower head Ø 20 cm.

CR

EQ32X8MPMD25

Soffione Ø 25 cm.
Shower head Ø 25 cm.

CR

EQ32X8MPMD30

Soffione Ø 30 cm.
Shower head Ø 30 cm.

CR



COLONNE DOCCIA TERMOSTATICHE TONDE

THERMOSTATICS ROUND SHOWER COLUMNS

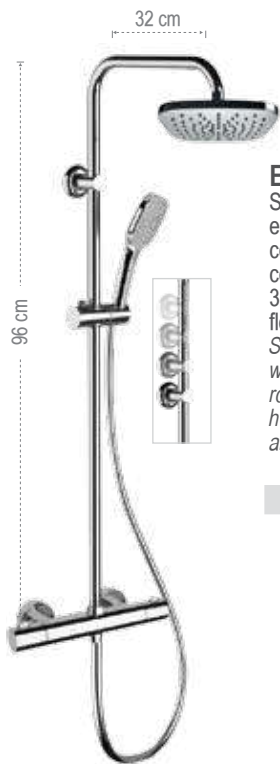

EQ32X8CPAD20

Set doccia composto da: miscelatore termostatico esterno con deviatore, soffione in abs 20x20cm con angoli arrotondati 356AD20X, colonna doccia con fissaggio superiore regolabile in altezza 329X, doccetta in abs con 3 funzioni 318CP, flessibile 150 cm.

Shower set including: exposed thermostatic mixer with diverter, abs 20x20 cm shower head with rounded corners 356AD20X, shower column with height-adjustable upper fixing 329X, 3-function abs hand shower 318CP, 150 cm flexible hose.

CR



EQ37330FG

Set doccia composto da: Miscelatore termostatico con deviatore, colonna doccia con fissaggio superiore scorrevole, doccetta 3 funzioni (319MO), soffione in abs Ø20 cm (356MD20X), flessibile 150 cm.

Shower set including: thermostatic mixer with diverter, shower column with sliding top fixing, 3-function hand shower (319MO), Ø20 cm abs shower head (356MD20X), 150 cm hose.

CR

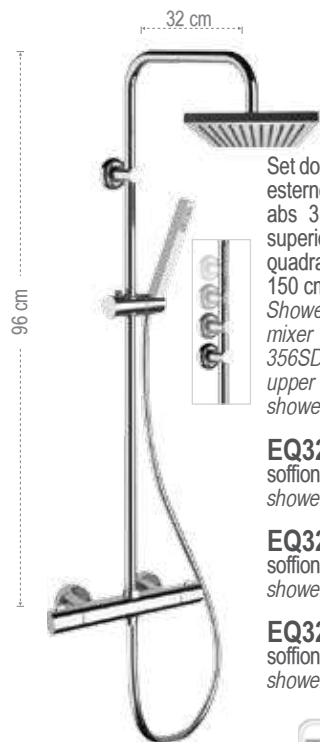

Set doccia composto da: miscelatore termostatico esterno con deviatore, soffione 20x20 cm in abs 356SD20X, colonna doccia con fissaggio superiore regolabile in altezza 329X, doccetta quadrata in ABS, 1 funzione 317SD, flessibile 150 cm.

Shower set including: exposed thermostatic mixer with diverter, abs 20x20 cm shower head 356SD20X, shower column with height-adjustable upper fixing 329X, 1-function abs square hand shower 317SD, 150 cm flexible hose.

EQ32X7SDSD20

soffione 20x20 cm.
shower head 20x20 cm.

CR

EQ32X7SDSD25

soffione 25x25 cm.
shower head 25x25 cm.

CR

EQ32X7SDSD30

soffione 30x30 cm.
shower head 30x30 cm.

CR

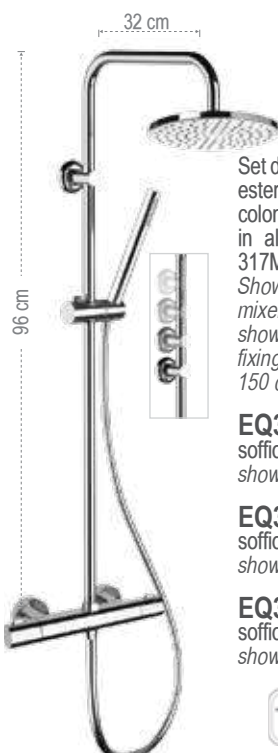

Set doccia composto da: miscelatore termostatico esterno con deviatore, soffione in abs 356MD20X, colonna doccia con fissaggio superiore regolabile in altezza 329X, doccetta in abs, 1 funzione 317MD, flessibile 150 cm.

Shower set including: exposed thermostatic mixer with diverter, abs shower head 356MD20X, shower column with height-adjustable upper fixing 329X, 1-function abs hand shower 317MD, 150 cm flexible hose.

EQ32X7MDMD20

soffione Ø20 cm.
shower head Ø20 cm.

CR

EQ32X7MDMD25

soffione Ø25 cm.
shower head Ø25 cm.

CR

EQ32X7MDMD30

soffione Ø30 cm.
shower head Ø30 cm.

CR



BOX INCASSO BUILT-IN BOX
 A PULSANTE PUSH-BUTTON
 TERMOSTATICI THERMOSTATICS
 COLONNE DOCCIA SHOWER COLUMNS
 KIT WELLNESS WELLNESS KIT
 CROMOTERAPIA COLOR THERAPY
 SOFFIONI SHOWER HEADS
 BOCCHE SPOUTS
 PANNELLI DOCCIA SHOWER PANELS
 SALISCENDI SLIDING RAILS
 DOCCETTE HANDSHOWERS
 BORDO VASCA DECK BATH MIXERS

COLONNE DOCCIA TERMOSTATICHE TELESCOPICHE
TELESCOPIC THERMOSTATIC SHOWER COLUMNS

Set doccia composto da: miscelatore termostatico esterno con deviatore, soffione in acciaio inox 357UFM20X, colonna doccia in ottone telescopica, altezza asta regolabile 329A, doccetta in abs con 3 funzioni 318MP, flessibile 150 cm.

Shower set including: exposed thermostatic mixer with diverter, stainless steel shower head 357UFM20X, telescopic brass shower column, with height-adjustable rod 329A, 3-function abs hand shower 318MP, 150 cm flexible hose.

EQ32A8MPUFM20 soffione Ø 20 cm. shower head Ø 20 cm.	CR	NO
EQ32A8MPUFM25 soffione Ø 25 cm. shower head Ø 25 cm.	CR	NO
EQ32A8MPUFM30 soffione Ø 30 cm. shower head Ø 30 cm.	CR	NO



Set doccia composto da: miscelatore termostatico esterno con deviatore, soffione in abs 356SD20X, colonna doccia in ottone telescopica, altezza asta regolabile 329A, doccetta quadrata in ABS, 1 funzione 317SD, flessibile 150 cm.

Shower set including: exposed thermostatic mixer with diverter, abs shower head 356SD20X, telescopic brass shower column, with height-adjustable rod 329A, 1-function abs square hand shower 317SD, 150 cm flexible hose.

EQ32A7SDSD20 soffione 20x20 cm. shower head 20x20 cm.	CR	
EQ32A7SDSD25 soffione 25x25 cm. shower head 25x25 cm.	CR	
EQ32A7SDSD30 soffione 30x30 cm. shower head 30x30 cm.	CR	



Set doccia composto da: miscelatore termostatico esterno con deviatore, soffione in acciaio inox con angoli arrotondati 357UFD20X, colonna doccia in ottone telescopica, altezza asta regolabile 329A, doccetta quadrata in ABS, 1 funzione 317SD, flessibile 150 cm.

Shower set including: exposed thermostatic mixer with diverter, stainless steel shower head with rounded corners 357UFD20X, telescopic brass shower column, with height-adjustable rod 329A, 1-function abs square hand shower 317SD, 150 cm flexible hose.

EQ32A7SDUFD20 soffione 20X20 cm. shower head 20X20 cm.	CR	
EQ32A7SDUFD25 soffione 25X25 cm. shower head 25X25 cm.	CR	
EQ32A7SDUFD30 soffione 30X30 cm. shower head 30X30 cm.	CR	



Set doccia composto da: miscelatore termostatico esterno con deviatore, soffione in acciaio inox con angoli arrotondati 357UFD20X, colonna doccia in ottone telescopica, altezza asta regolabile 329A, doccetta in abs con 3 funzioni 318CP, flessibile 150 cm.

Shower set including: exposed thermostatic mixer with diverter, stainless steel shower head with rounded corners 357UFD20X, telescopic brass shower column, with height-adjustable rod 329A, 3-function abs hand shower 318CP, 150 cm flexible hose.

EQ32A8CPUFD20 Soffione Ø 20 cm. Shower head Ø 20 cm.	CR	NO
EQ32A8CPUFD25 Soffione Ø 25 cm. Shower head Ø 25 cm.	CR	NO
EQ32A8CPUFD30 Soffione Ø 30 cm. Shower head Ø 30 cm.	CR	NO





min. 103 cm - max. 157 cm
95 cm

EQ32AEC20

Set doccia composto da: miscelatore termostatico esterno con deviatore, soffione in abs Ø 20cm 354EC20X, colonna doccia in ottone telescopica, altezza asta regolabile 329A, doccetta in abs a 3 funzioni 319MO, flessibile 150 cm.

Shower set including: exposed thermostatic mixer with diverter, abs Ø 20 cm shower head 354EC20X, telescopic brass shower column, with height-adjustable rod 329A, 3-function abs hand shower 319MO, 150 cm flexible hose.

CR

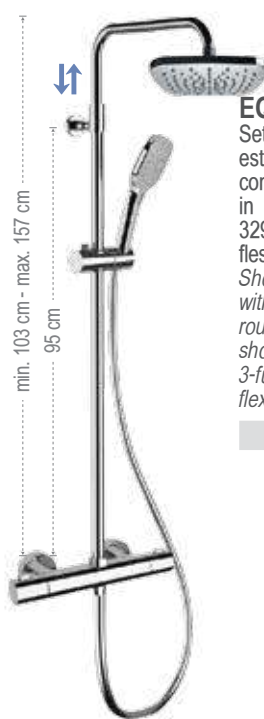

min. 103 cm - max. 157 cm
95 cm

EQ32A8CPAD20

Set doccia composto da: miscelatore termostatico esterno con deviatore, soffione in abs 20x20cm con angoli arrotondati 356AD20X, colonna doccia in ottone telescopica, altezza asta regolabile 329A, doccetta in abs con 3 funzioni 318CP, flessibile 150 cm.

Shower set including: exposed thermostatic mixer with diverter, abs 20x20 cm shower head with rounded corners 356AD20X, telescopic brass shower column, with height-adjustable rod 329A, 3-function abs hand shower 318CP, 150 cm flexible hose.

CR



min. 103 cm - max. 157 cm
95 cm

EQ32AUFM20

Soffione Ø 20 cm.
Shower head Ø 20 cm.

CR

EQ32AUFM25

Soffione Ø 25 cm.
Shower head Ø 25 cm.

CR

EQ32AUFM30

Soffione Ø 30 cm.
Shower head Ø 30 cm.

CR



min. 103 cm - max. 157 cm
95 cm

Set doccia composto da: miscelatore termostatico esterno con deviatore, soffione in abs 356MD20X, colonna doccia in ottone telescopica, altezza asta regolabile 329A, doccetta in abs con 3 funzioni 318MP, flessibile 150 cm.

Shower set including: exposed thermostatic mixer with diverter, abs shower head 356MD20X, telescopic brass shower column, with height-adjustable rod 329A, 3-function abs hand shower 318MP, 150 cm flexible hose.

EQ32A8MPMD20

Soffione Ø 20 cm.
Shower head Ø 20 cm.

CR

EQ32A8MPMD25

Soffione Ø 25 cm.
Shower head Ø 25 cm.

CR

EQ32A8MPMD30

Soffione Ø 30 cm.
Shower head Ø 30 cm.

CR



COLONNE DOCCIA TERMOSTATICHE IN FINITURA
FINISHINGS TELESCOPIC THERMOSTATIC SHOWER COLUMNS



Set doccia composto da: miscelatore termostatico esterno con deviatore, soffione in ottone 359MM20X, colonna doccia con fissaggio superiore regolabile in altezza 329X, doccetta minimale in ottone, 1 funzione 317MM, flessibile 150 cm.

Shower set including: exposed thermostatic mixer with diverter, brass shower head Ø 20 cm 359MM20X, shower column with height-adjustable upper fixing 329X, 1-function brass hand shower 317MM, 150 cm flexible hose.

EQ32X7MCM20

Soffione Ø 20 cm. Shower head Ø 20 cm.



EQ32X7MCM30

Soffione Ø 30 cm. Shower head Ø 30 cm.



EQ32U

Set doccia composto da: miscelatore termostatico esterno con deviatore, soffione in ottone Ø 20 cm 359MM20X, colonna doccia girevole in ottone 329U, doccetta minimale in ottone, 1 funzione 317MM, flessibile 150 cm.

Shower set including: exposed thermostatic mixer with diverter, brass shower head Ø 20 cm 359MM20X, brass swivel shower column 329U, 1-function brass hand shower 317MM, 150 cm flexible hose.





EQ32X7MMM20NO

BORDO VASCA
DECK BATH MIXERS

DOCCHETTE
HANDSHOWERS

SALISCENDI
SLIDING RAILS

PANNELLI DOCCIA
SHOWER PANELS

BOCCHE
SPOUTS

SOFFIONI
SHOWER HEADS

CROMOTERAPIA
COLORTHERAPY

KIT WELLNESS
WELLNESS KIT

COLONNE DOCCIA
SHOWER COLUMNS

TERMOSTATICI
THERMOSTATICS

A PULSANTE
PUSH-BUTTON

BOX INCASSO
BUILT-IN BOX

COLONNE DOCCIA TERMOSTATICHE QUADRATE THERMOSTATICS SQUARED SHOWER COLUMNS



Set doccia composto da: miscelatore termostatico esterno quadrato con deviatore, soffione in acciaio inox 357UFS20X, colonna doccia quadrata in ottone 329S, doccetta in abs a 1 funzione 317SQ, flessibile 150 cm.
Shower set including: square exposed thermostatic mixer with diverter, stainless steel shower head 357UFS20X, square brass shower column 329S, 1-function abs hand shower 317SQ, 150 cm flexible hose.

ST32LS7SQUFS20 soffione 20x20 cm. showerhead 20x20 cm.	CR	<input type="checkbox"/>
ST32LS7SQUFS25 soffione 25x25 cm. showerhead 25x25 cm.	CR	<input type="checkbox"/>
ST32LS7SQUFS30 soffione 30x30 cm. showerhead 30x30 cm.	CR	<input type="checkbox"/>





Set doccia composto da: miscelatore termostatico esterno quadrato con deviatore, soffione in abs 356SD20X, colonna doccia quadrata in ottone 329S, doccetta quadrata in ABS, 1 funzione 317SD, flessibile 150 cm.
Shower set including: square exposed thermostatic mixer with diverter, abs shower head 356SD20X, square brass shower column 329S, 1-function abs square hand shower 317SD, 150 cm flexible hose.

ST32S7SDSD20 soffione 20x20 cm. showerhead 20x20 cm.	CR	<input type="checkbox"/>
ST32S7SDSD25 soffione 25x25 cm. showerhead 25x25 cm.	CR	<input type="checkbox"/>
ST32S7SDSD30 soffione 30x30 cm. showerhead 30x30 cm.	CR	<input type="checkbox"/>



Set doccia composto da: miscelatore termostatico esterno quadrato con deviatore, soffione in acciaio inox 357UFS20X, colonna doccia con fissaggio superiore regolabile in altezza 329X, doccetta quadrata in ABS, 1 funzione 317SD, flessibile 150 cm.
Shower set including: square exposed thermostatic mixer with diverter, stainless steel shower head 357UFS20X, shower column with height-adjustable upper fixing 329X, 1-function abs square hand shower 317SD, 150 cm flexible hose.

ST32X7SDUFS20 soffione 20x20 cm. showerhead 20x20 cm.	CR	NO	<input type="checkbox"/>
ST32X7SDUFS25 soffione 25x25 cm. showerhead 25x25 cm.	CR	NO	<input type="checkbox"/>
ST32X7SDUFS30 soffione 30x30 cm. showerhead 30x30 cm.	CR	NO	<input type="checkbox"/>



COLONNE DOCCIA TERMOSTATICHE TELESCOPICHE TELESCOPIC THERMOSTATIC SHOWER COLUMNS



Set doccia composto da: miscelatore termostatico esterno quadrato con deviatore, soffione in acciaio inox 357UFS20X, colonna doccia in ottone telescopica, altezza asta regolabile 329A, doccetta quadrata in ABS, 1 funzione 317SD, flessibile 150 cm.

Shower set including: square exposed thermostatic mixer with diverter, stainless steel shower head 357UFS20X, telescopic brass shower column, with height-adjustable rod 329A, 1-function abs square hand shower 317SD, 150 cm flexible hose.

ST32A7SDUFS20 soffione 20x20 cm. <i>showerhead 20x20 cm.</i>	CR	NO
ST32A7SDUFS25 soffione 25x25 cm. <i>showerhead 25x25 cm.</i>	CR	NO
ST32A7SDUFS30 soffione 30x30 cm. <i>showerhead 30x30 cm.</i>	CR	NO



COLONNE DOCCIA TERMOSTATICHE IN FINITURA FINISHINGS TELESCOPIC THERMOSTATIC SHOWER COLUMNS

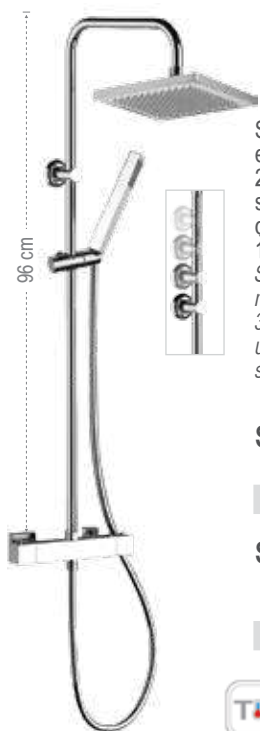

Set doccia composto da: miscelatore termostatico esterno quadrato con deviatore, soffione in ottone 20x20cm 359SSX, colonna doccia con fissaggio superiore regolabile in altezza 329X, doccetta quadrata in ottone a 1 funzione 317SS, flessibile 150 cm.

Shower set including: square exposed thermostatic mixer with diverter, brass shower head 20x20cm 359SSX, shower column with height-adjustable upper fixing 329X, 1-function brass square hand shower 317SS, 150 cm flexible hose.

ST32LX7AU9SS	CR	FIN 1	FIN 2
ST32LX7AUSSL	CR	FIN 1	FIN 2

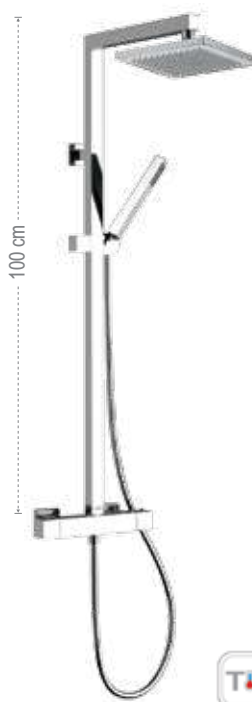

Set doccia composto da: miscelatore termostatico esterno quadrato con deviatore, soffione in ottone 20x20cm 359SSX, colonna doccia quadrata in ottone 329S, doccetta quadrata in ottone a 1 funzione 317SS, flessibile 150 cm.

Shower set including: square exposed thermostatic mixer with diverter, brass shower head 20x20cm 359SSX, square brass shower column 329S, 1-function brass square hand shower 317SS, 150 cm flexible hose.

ST32LS7AU9SS	CR	FIN 1	FIN 2
ST32LS7AUSSL	CR	FIN 1	FIN 2



COLONNE DOCCIA - SHOWER COLUMNS

COLONNE DOCCIA SHOWER COLUMNS



La colonna doccia è una soluzione pratica e versatile che permette di godere di tutta la comodità di un soffione e di una doccia senza la necessità di parti ad incasso. Disponibili con miscelazione tradizionale, termostatica o con l'attacco per un miscelatore esterno, le colonne doccia sono proposte in un'ampia gamma di varianti per poter sempre scegliere il design e le funzioni che meglio soddisfano le vostre esigenze.

The shower column is a practical and versatile solution that allows you to enjoy all the convenience of a shower head and hand shower without the need for recessed parts. Available with traditional, thermostatic mixing or with the connection for an external mixer, the shower columns are offered in a wide range of variants so that you can always choose the design and functions that best meet your needs.



COLONNE DOCCIA A 3 VIE - 3 WAYS SHOWER COLUMNS

L34X7MCM20
 Set doccia composto da: miscelatore esterno con deviatore vasca/doccia, soffione in ottone Ø 20 cm 359MM20X, colonna doccia con fissaggio superiore regolabile in altezza 329X, doccetta minimale in ottone, 1 funzione 317MM, flessibile 150 cm.
 Shower set including: exposed mixer with bath/shower diverter, brass shower head Ø 20 cm 359MM20X, shower column with height-adjustable upper fixing 329X, 1-function brass hand shower 317MM, 150 cm flexible hose.

CR FIN 1 FIN 2

EY34X7AU9SS
 Set doccia composto da: miscelatore esterno con deviatore vasca/doccia, soffione in ottone 20x20cm 359SSX, colonna doccia con fissaggio superiore regolabile in altezza 329X, doccetta quadrata in ottone a 1 funzione 317SS, flessibile 150 cm.
 Shower set including: exposed mixer with bath/shower diverter, brass shower head 20x20cm 359SSX, shower column with height-adjustable upper fixing 329X, 1-function brass square hand shower 317SS, 150 cm flexible hose.

CR FIN 1 FIN 2

W34AEC20
 Set doccia composto da: miscelatore esterno con deviatore vasca/doccia, soffione in abs Ø 20cm 354EC20X, colonna doccia in ottone telescopica, altezza asta regolabile 329A, doccetta in abs a 3 funzioni 319MO, flessibile 150 cm.
 Shower set including: exposed mixer with bath/shower diverter, abs Ø 20 cm shower head 354EC20X, telescopic brass shower column, with height-adjustable rod 329A, 3-function abs hand shower 319MO, 150 cm flexible hose.

CR

W34A8MPEC20
 Set doccia composto da: miscelatore esterno con deviatore vasca/doccia, soffione in abs Ø 20cm 354EC20X, colonna doccia in ottone telescopica, altezza asta regolabile 329A, doccetta in abs con 3 funzioni 318MP, flessibile 150 cm.
 Shower set including: exposed mixer with bath/shower diverter, abs Ø 20 cm shower head 354EC20X, telescopic brass shower column, with height-adjustable rod 329A, 3-function abs hand shower 318MP, 150 cm flexible hose.

CR

**EY34AEC20**

Set doccia composto da: miscelatore esterno con deviatore vasca/doccia, soffione in abs Ø 20cm 354EC20X, colonna doccia in ottone telescopica, altezza asta regolabile 329A, doccetta in abs con 3 funzioni 318MP, flessibile 150 cm.

Shower set including: exposed mixer with bath/shower diverter, abs Ø 20 cm shower head 354EC20X, telescopic brass shower column, with height-adjustable rod 329A, 3-function abs hand shower 318MP, 150 cm flexible hose.

CR

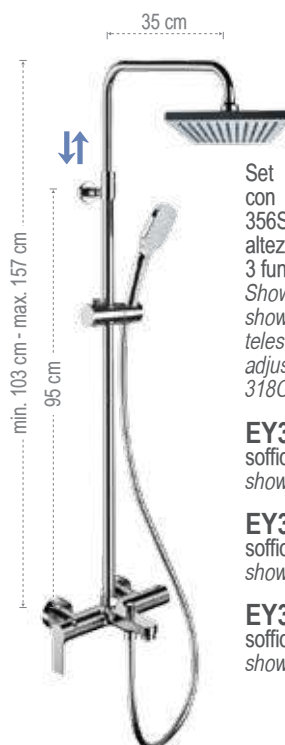

Set doccia composto da: miscelatore esterno con deviatore vasca/doccia, soffione in abs 356SD20X, colonna doccia in ottone telescopica, altezza asta regolabile 329A, doccetta in abs con 3 funzioni 318CP, flessibile 150 cm.

Shower set including: exposed mixer with bath/shower diverter, abs shower head 356SD20X, telescopic brass shower column, with height-adjustable rod 329A, 3-function abs hand shower 318CP, 150 cm flexible hose.

EY34ASD20

soffione 20x20 cm.
showerhead 20x20 cm.

CR

EY34ASD25

soffione 25x25 cm.
showerhead 25x25 cm.

CR

EY34ASD30

soffione 30x30 cm.
showerhead 30x30 cm.

CR



Set doccia composto da: miscelatore esterno con deviatore vasca/doccia, soffione in abs 356MD20X, colonna doccia in ottone telescopica, altezza asta regolabile 329A, doccetta in abs a 3 funzioni 319MO, flessibile 150 cm.

Shower set including: external mixer with bath/shower diverter, abs shower head 356MD20X, telescopic brass shower column, height-adjustable rod 329A, 3-functions handshower in abs 319MO, 150 cm flexible hose.

L34AMD20

soffione da Ø20 cm.
shower head Ø20 cm.

CR

L34AMD25

soffione da Ø25 cm.
shower head Ø25 cm.

CR

L34AMD30

soffione da Ø30 cm.
shower head Ø30 cm.

CR



Set doccia composto da: miscelatore esterno con deviatore vasca/doccia, soffione in acciaio inox 357UFM20X, colonna doccia in ottone telescopica, altezza asta regolabile 329A, doccetta in abs a 3 funzioni 319MO, flessibile 150 cm.

Shower set including: external mixer with bath/shower diverter, stainless steel shower head 357UFM20X, telescopic brass shower column, height-adjustable rod 329A, 3-functions handshower in abs 319MO, 150 cm flexible hose.

L34AUFM20

soffione da Ø20 cm.
shower head Ø20 cm.

CR

L34AUFM25

soffione da Ø25 cm.
shower head Ø25 cm.

CR

L34AUFM30

soffione da Ø30 cm.
shower head Ø30 cm.

CR



COLONNE DOCCIA - SHOWER COLUMNS

Set doccia composto da: miscelatore esterno con deviatore vasca/doccia, soffione in acciaio inox 20x20cm con angoli arrotondati 357UFD20X, colonna doccia in ottone telescopica, altezza asta regolabile 329A, doccetta in abs a 3 funzioni 319MO, flessibile 150 cm.

Shower set including: exposed mixer with bath/shower diverter, stainless steel 20x20 cm shower head with rounded corners 357UFD20X, telescopic brass shower column, with height-adjustable rod 329A, 3-function abs hand shower 319MO, 150 cm flexible hose.

I34AUFD20 soffione da 20x20 cm. shower head 20x20 cm.	CR
I34AUFD25 soffione da 25x25 cm. shower head 25x25 cm.	CR
I34AUFD30 soffione da 30x30 cm. shower head 30x30 cm.	CR



Set doccia composto da: miscelatore esterno con deviatore vasca/doccia, soffione in acciaio inox con angoli arrotondati 357UFD20X, colonna doccia in ottone telescopica, altezza asta regolabile 329A, doccetta in abs a 3 funzioni 319MO, flessibile 150 cm.

Shower set including: exposed mixer with bath/shower diverter, stainless steel shower head with rounded corners 357UFD20X, telescopic brass shower column, with height-adjustable rod 329A, 3-function abs hand shower 319MO, 150 cm flexible hose.

D34AUFD20 soffione da 20x20 cm. shower head 20x20 cm.	CR
D34AUFD25 soffione da 25x25 cm. shower head 25x25 cm.	CR
D34AUFD30 soffione da 30x30 cm. shower head 30x30 cm.	CR



Set doccia composto da: miscelatore esterno con deviatore vasca/doccia, soffione in abs 20x20cm con angoli arrotondati 356AD20X, colonna doccia in ottone telescopica, altezza asta regolabile 329A, doccetta in abs a 3 funzioni 319MO, flessibile 150 cm.

Shower set including: exposed mixer with bath/shower diverter, abs 20x20 cm shower head with rounded corners 356AD20X, telescopic brass shower column, with height-adjustable rod 329A, 3-function abs hand shower 319MO, 150 cm flexible hose.

I34AAD20	CR
-----------------	----



Set doccia composto da: miscelatore esterno con deviatore vasca/doccia, soffione in abs 20x20cm con angoli arrotondati 356AD20X, colonna doccia in ottone telescopica, altezza asta regolabile 329A, doccetta in abs a 3 funzioni 319MO, flessibile 150 cm.

Shower set including: exposed mixer with bath/shower diverter, abs 20x20 cm shower head with rounded corners 356AD20X, telescopic brass shower column, with height-adjustable rod 329A, 3-function abs hand shower 319MO, 150 cm flexible hose.

D34AAD20	CR
-----------------	----





D34AAD20

WELLNESS

- BORDO VASCA
DECK BATH MIXERS
- DOCCHETTE
HANDSHOWERS
- SALISCENDI
SLIDING RAILS
- PANNELLI DOCCIA
SHOWER PANELS
- BOCCHE
SPOUTS
- SOFFIONI
SHOWER HEADS
- CROMOTERAPIA
COLOR THERAPY
- KIT WELLNESS
WELLNESS KIT
- COLONNE DOCCIA
SHOWER COLUMNS
- TERMOSTATICI
THERMOSTATICS
- A PULSANTE
PUSH-BUTTON
- BOX INCASSO
BUILT-IN BOX

COLONNE DOCCIA TELESCOPICHE CON PRESA ACQUA ESTERNA
TELESCOPIC SHOWER COLUMNS WITH EXTERNAL WATER PUNCH



min. 103 cm - max. 157 cm
95 cm
35 cm

Set doccia composto da: soffione tondo ultrapiatto in acciaio inox lucidato a specchio 357UFM20X, colonna doccia in ottone telescopica, con asta ad altezza regolabile 329A; supporto colonna con deviatore integrato e presa acqua inferiore 330NRA; doccetta in abs 3 funzioni 318MP; flessibile 50 cm per collegamento esterno, 1/2Fx1/2F; flessibile 150 cm.
Shower set including: round ultra-flat shower head in mirror-polished stainless steel 357UFM20X, telescopic brass shower column, with height-adjustable rod 329A; column holder with integrated diverter and lower water intake 330NRA; 3-function abs shower 318MP; flexible 50 cm for external connection, 1/2Fx1/2F; flexible hose 150 cm.

330A8MPUFM20NRA	CR	NO
soffione Ø 20 cm.	<input type="checkbox"/>	<input type="checkbox"/>
shower head Ø 20 cm.	<input type="checkbox"/>	<input type="checkbox"/>

330A8MPUFM25NRA	CR	NO
soffione Ø 25 cm.	<input type="checkbox"/>	<input type="checkbox"/>
shower head Ø 25 cm.	<input type="checkbox"/>	<input type="checkbox"/>

330A8MPUFM30NRA	CR	NO
soffione Ø 30 cm.	<input type="checkbox"/>	<input type="checkbox"/>
shower head Ø 30 cm.	<input type="checkbox"/>	<input type="checkbox"/>





min. 103 cm - max. 157 cm
95 cm
35 cm

Set doccia composto da: soffione in acciaio inox con angoli arrotondati 357UFD20X, colonna doccia in ottone telescopica, altezza asta regolabile 329A, supporto colonna con deviatore integrato e presa acqua inferiore, doccetta in abs con 3 funzioni 318CP, flessibile 50 cm per collegamento esterno, 1/2Fx1/2F, flessibile 150 cm.
Shower set including: stainless steel shower head with rounded corners 357UFD20X, telescopic brass shower column, with height-adjustable rod 329A, column holder with integrated diverter and lower water connection, 3-function abs hand shower 318CP, 50 cm flexible hose for external connection, 1/2Fx1/2F, 150 cm flexible hose.

330A8CPUFD20NRA	CR	NO
soffione 20x20 cm.	<input type="checkbox"/>	<input type="checkbox"/>
shower head 20x20 cm.	<input type="checkbox"/>	<input type="checkbox"/>

330A8CPUFD25NRA	CR	NO
soffione 25x25 cm.	<input type="checkbox"/>	<input type="checkbox"/>
shower head 25x25 cm.	<input type="checkbox"/>	<input type="checkbox"/>

330A8CPUFD30NRA	CR	NO
soffione 30x30 cm.	<input type="checkbox"/>	<input type="checkbox"/>
shower head 30x30 cm.	<input type="checkbox"/>	<input type="checkbox"/>



min. 103 cm - max. 157 cm
95 cm
35 cm

330A8MPEC20NRA
Set doccia composto da: soffione Ø 20 cm in abs cromato 354EC20X, colonna doccia in ottone telescopica, con asta ad altezza regolabile 329A; supporto colonna con deviatore integrato e presa acqua inferiore 330NRA; doccetta in abs 3 funzioni 318MP; flessibile 50 cm per collegamento esterno, 1/2Fx1/2F; flessibile 150 cm.
Shower set including: Ø 20 cm c.p. abs shower head 354EC20X, telescopic brass shower column, with height-adjustable rod 329A; column holder with integrated diverter and lower water intake 330NRA; 3-function abs shower 318MP; flexible 50 cm for external connection, 1/2Fx1/2F; flexible hose 150 cm.

CR

min. 103 cm - max. 157 cm
95 cm
35 cm

330A8CPAD20NRA
Set doccia composto da: soffione in abs 20x20cm con angoli arrotondati 356AD20X, colonna doccia in ottone telescopica, altezza asta regolabile 329A, supporto colonna con deviatore integrato e presa acqua inferiore, doccetta in abs con 3 funzioni 318CP, flessibile 50 cm per collegamento esterno, 1/2Fx1/2F, flessibile 150 cm.
Shower set including: abs 20x20 cm shower head with rounded corners 356AD20X, telescopic brass shower column, with height-adjustable rod 329A, column holder with integrated diverter and lower water connection, 3-function abs hand shower 318CP, 50 cm flexible hose for external connection, 1/2Fx1/2F, 150 cm flexible hose.

CR



COLONNE DOCCIA CON PRESA ACQUA ESTERNA SHOWER COLUMNS WITH EXTERNAL WATER PUNCH



COLONNE DOCCIA CON MISCELATORE
SHOWER COLUMNS WITH SHOWER MIXER

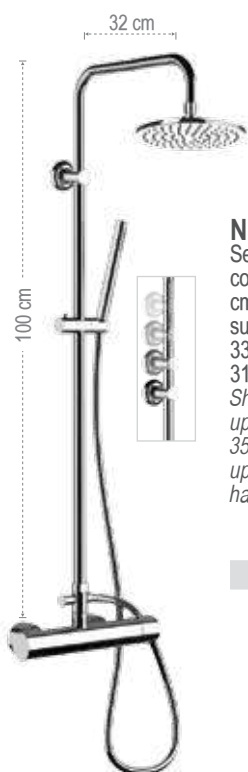

N37RX7MCM20

Set doccia composto da: miscelatore esterno con attacco superiore, soffione in ottone Ø 20 cm 359MM20X, colonna doccia con fissaggio superiore regolabile in altezza, con deviatore 330X, doccetta minimale in ottone, 1 funzione 317MM, flessibile 150 cm.

Shower set including: exposed mixer with upper connection, brass shower head Ø 20 cm 359MM20X, shower column with height-adjustable upper fixing and diverter 330X, 1-function brass hand shower 317MM, 150 cm flexible hose.

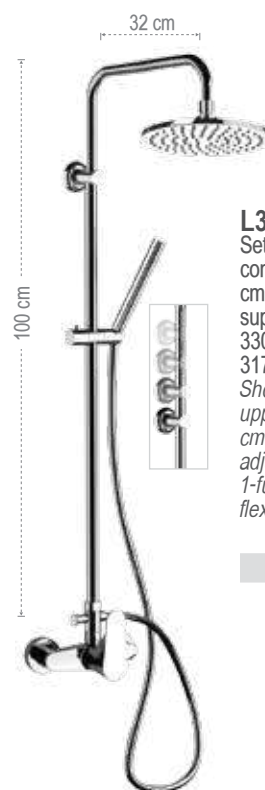

L37X7MCM20

Set doccia composto da: miscelatore esterno con attacco superiore, soffione in ottone Ø 20 cm 359MM20X, colonna doccia con fissaggio superiore regolabile in altezza, con deviatore 330X, doccetta minimale in ottone, 1 funzione 317MM, flessibile 150 cm.

Shower set including: exposed mixer with upper connection, brass shower head Ø 20 cm 359MM20X, shower column with height-adjustable upper fixing and diverter 330X, 1-function brass hand shower 317MM, 150 cm flexible hose.

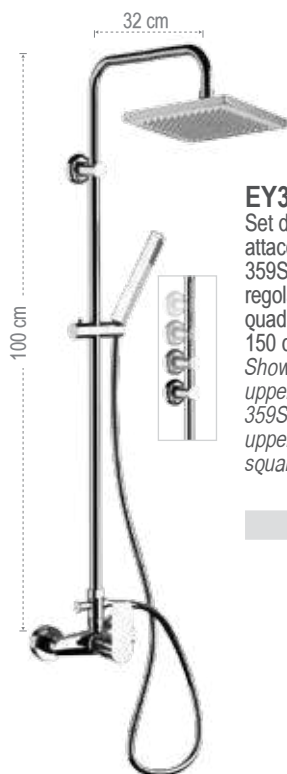

EY37X7AU9SS

Set doccia composto da: miscelatore esterno con attacco superiore, soffione in ottone 20x20cm 359SSX, colonna doccia con fissaggio superiore regolabile in altezza, con deviatore 330X, doccetta quadrata in ottone a 1 funzione 317SS, flessibile 150 cm.

Shower set including: exposed mixer with upper connection, brass shower head 20x20cm 359SSX, shower column with height-adjustable upper fixing and diverter 330X, 1-function brass square hand shower 317SS, 150 cm flexible hose.



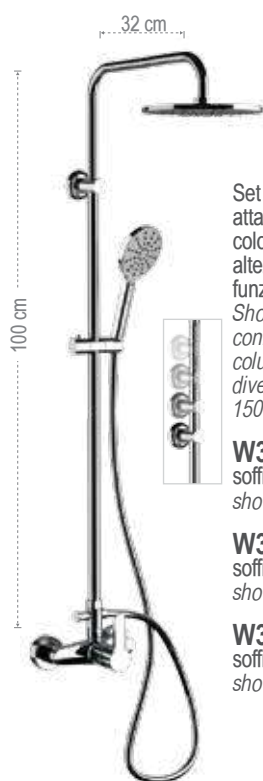

Set doccia composto da: miscelatore esterno con attacco superiore, soffione in abs 356MD20X, colonna doccia con fissaggio superiore regolabile in altezza, con deviatore 330X, doccetta in abs con 3 funzioni 318MP, flessibile 150 cm.

Shower set including: exposed mixer with upper connection, abs shower head 356MD20X, shower column with height-adjustable upper fixing and diverter 330X, 3-function abs hand shower 318MP, 150 cm flexible hose.

W37X8MPMD20

soffione Ø 20 cm.
shower head Ø 20 cm.

CR

W37X8MPMD25

soffione Ø 25 cm.
shower head Ø 25 cm.

CR

W37X8MPMD30

soffione Ø 30 cm.
shower head Ø 30 cm.

CR

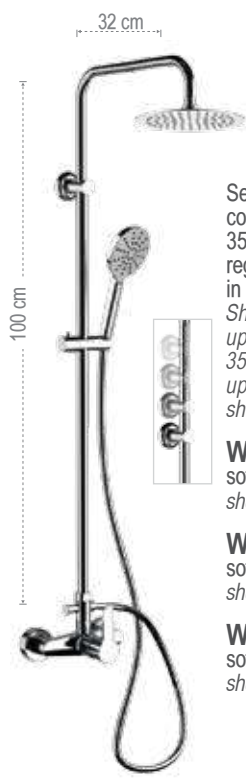

Set doccia composto da: miscelatore esterno con attacco superiore, soffione in acciaio inox 357UFM20X, colonna doccia con fissaggio superiore regolabile in altezza, con deviatore 330X, doccetta in abs con 3 funzioni 318MP, flessibile 150 cm.

Shower set including: exposed mixer with upper connection, stainless steel shower head 357UFM20X, shower column with height-adjustable upper fixing and diverter 330X, 3-function abs hand shower 318MP, 150 cm flexible hose.

W37X8MPUFM20

soffione Ø 20 cm.
shower head Ø 20 cm.

CR

NO

W37X8MPUFM25

soffione Ø 25 cm.
shower head Ø 25 cm.

CR

NO

W37X8MPUFM30

soffione Ø 30 cm.
shower head Ø 30 cm.

CR

NO

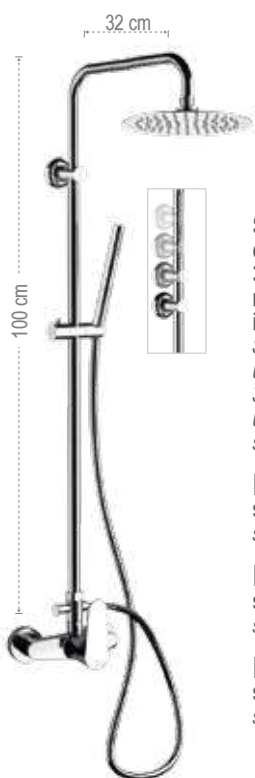

Set doccia composto da: miscelatore esterno con attacco superiore, soffione in acciaio inox 357UFM20X, colonna doccia con fissaggio superiore regolabile in altezza, con deviatore 330X, doccetta in abs, 1 funzione 317MD, flessibile 150 cm.

Shower set including: exposed mixer with upper connection, stainless steel shower head 357UFM20X, shower column with height-adjustable upper fixing and diverter 330X, 1-function abs hand shower 317MD, 150 cm flexible hose.

L37X7MDUFM20

soffione Ø 20 cm.
shower head Ø 20 cm.

CR

NO

L37X7MDUFM25

soffione Ø 25 cm.
shower head Ø 25 cm.

CR

NO

L37X7MDUFM30

soffione Ø 30 cm.
shower head Ø 30 cm.

CR

NO

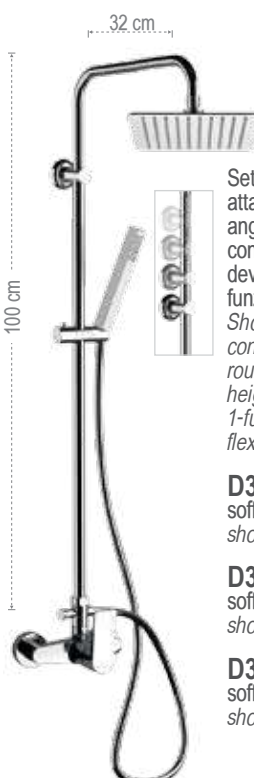

Set doccia composto da: miscelatore esterno con attacco superiore, soffione in acciaio inox con angoli arrotondati 357UFD20X, colonna doccia con fissaggio superiore regolabile in altezza, con deviatore 330X, doccetta quadrata in ABS, 1 funzione 317SD, flessibile 150 cm.

Shower set including: exposed mixer with upper connection, stainless steel shower head with rounded corners 357UFD20X, shower column with height-adjustable upper fixing and diverter 330X, 1-function abs square hand shower 317SD, 150 cm flexible hose.

D37X7SDUFD20

soffione 20x20 cm.
shower head 20x20 cm.

CR

NO

D37X7SDUFD25

soffione 25x25 cm.
shower head 25x25 cm.

CR

NO

D37X7SDUFD30

soffione 30x30 cm.
shower head 30x30 cm.

CR

NO



COLONNE DOCCIA - SHOWER COLUMNS

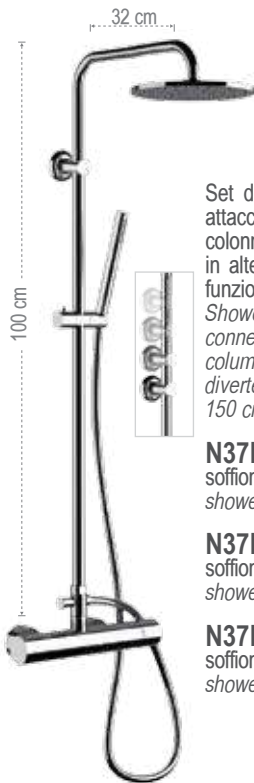

Set doccia composto da: miscelatore esterno con attacco superiore, soffione in abs 356MD20X, colonna doccia con fissaggio superiore regolabile in altezza, con deviatore 330X, doccetta in abs, 1 funzione 317MD, flessibile 150 cm.

Shower set including: exposed mixer with upper connection, abs shower head 356MD20X, shower column with height-adjustable upper fixing and diverter 330X, 1-function abs hand shower 317MD, 150 cm flexible hose.

N37RXMD20

soffione Ø 20 cm.
shower head Ø 20 cm.

CR

N37RXMD25

soffione Ø 25 cm.
shower head Ø 25 cm.

CR

N37RXMD30

soffione Ø 30 cm.
shower head Ø 30 cm.

CR

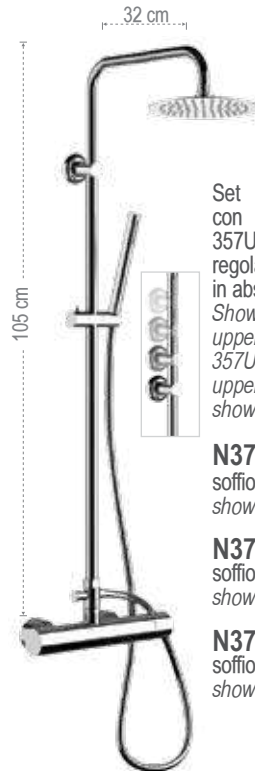

Set doccia composto da: miscelatore esterno con attacco superiore, soffione in acciaio inox 357UFM20X, colonna doccia con fissaggio superiore regolabile in altezza, con deviatore 330X, doccetta in abs, 1 funzione 317MD, flessibile 150 cm.

Shower set including: exposed mixer with upper connection, stainless steel shower head 357UFM20X, shower column with height-adjustable upper fixing and diverter 330X, 1-function abs hand shower 317MD, 150 cm flexible hose.

N37RXUFM20

soffione Ø 20 cm.
shower head Ø 20 cm.

CR

NO

N37RXUFM25

soffione Ø 25 cm.
shower head Ø 25 cm.

CR

NO

N37RXUFM30

soffione Ø 30 cm.
shower head Ø 30 cm.

CR

NO

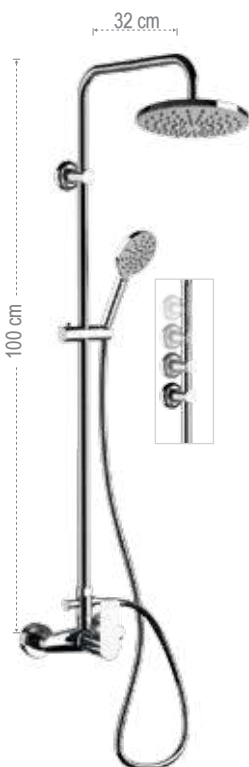

EY37XEC20

Set doccia composto da: miscelatore esterno con attacco superiore, soffione in abs Ø 20cm 354EC20X, colonna doccia con fissaggio superiore regolabile in altezza, con deviatore 330X, doccetta in abs con 3 funzioni 318MP, flessibile 150 cm.

Shower set including: exposed mixer with upper connection, abs Ø 20 cm shower head 354EC20X, shower column with height-adjustable upper fixing and diverter 330X, 3-function abs hand shower 318MP, 150 cm flexible hose.

CR

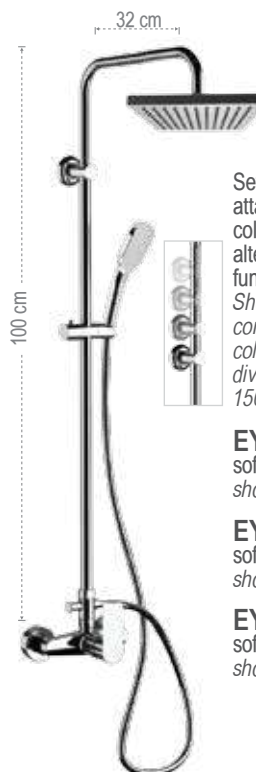

Set doccia composto da: miscelatore esterno con attacco superiore, soffione in abs 356SD20X, colonna doccia con fissaggio superiore regolabile in altezza, con deviatore 330X, doccetta in abs con 3 funzioni 318CP, flessibile 150 cm.

Shower set including: exposed mixer with upper connection, abs shower head 356SD20X, shower column with height-adjustable upper fixing and diverter 330X, 3-function abs hand shower 318CP, 150 cm flexible hose.

EY37XSD20

soffione 20x20 cm.
shower head 20x20 cm.

CR

EY37XSD25

soffione 25x25 cm.
shower head 25x25 cm.

CR

EY37XSD30

soffione 30x30 cm.
shower head 30x30 cm.

CR





N37RXUFM20

COLONNE DOCCIA TELESCOPICHE CON MISCELATORE
TELESCOPIC SHOWER COLUMNS WITH SHOWER MIXER

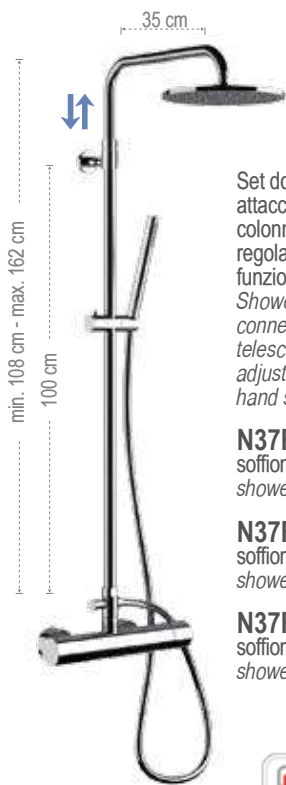

Set doccia composto da: miscelatore esterno con attacco superiore, soffione in abs 356MD20X, colonna doccia in ottone telescopica, altezza asta regolabile, con deviatore 330A, doccetta in abs, 1 funzione 317MD, flessibile 150 cm.
Shower set including: exposed mixer with upper connection, abs shower head 356MD20X, telescopic brass shower column, with height-adjustable rod, with diverter 330A, 1-function abs hand shower 317MD, 150 cm flexible hose.

N37RAMD20 soffione Ø 20 cm. shower head Ø 20 cm.	CR	<input type="checkbox"/>	<input type="checkbox"/>
N37RAMD25 soffione Ø 25 cm. shower head Ø 25 cm.	CR	<input type="checkbox"/>	<input type="checkbox"/>
N37RAMD30 soffione Ø 30 cm. shower head Ø 30 cm.	CR	<input type="checkbox"/>	<input type="checkbox"/>

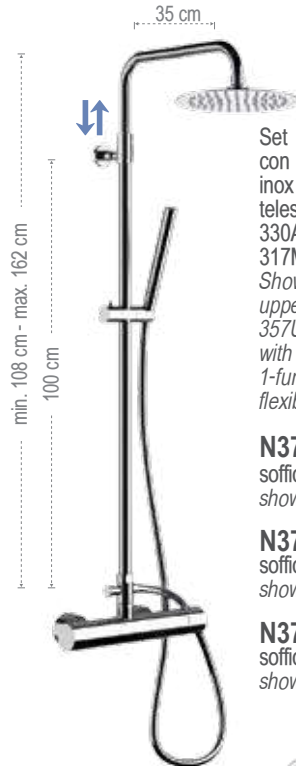

Set doccia composto da: miscelatore esterno con attacco superiore, soffione in acciaio inox 357UFM20X, colonna doccia in ottone telescopica, altezza asta regolabile, con deviatore 330A, doccetta minimale in ottone, 1 funzione 317MM, flessibile 150 cm.

Shower set including: exposed mixer with upper connection, stainless steel shower head 357UFM20X, telescopic brass shower column, with height-adjustable rod, with diverter 330A, 1-function brass hand shower 317MM, 150 cm flexible hose.

N37RA7MUCUFM20 soffione Ø 20 cm. shower head Ø 20 cm.	CR	<input type="checkbox"/>	<input type="checkbox"/>
N37RA7MUCUFM25 soffione Ø 25 cm. shower head Ø 25 cm.	CR	<input type="checkbox"/>	<input type="checkbox"/>
N37RA7MUCUFM30 soffione Ø 30 cm. shower head Ø 30 cm.	CR	<input type="checkbox"/>	<input type="checkbox"/>

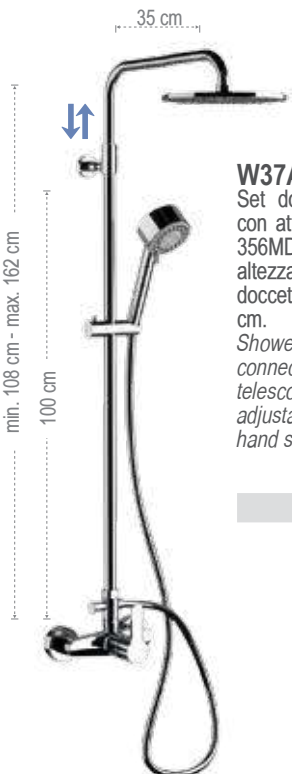

W37AMD20
Set doccia composto da: miscelatore esterno con attacco superiore, soffione in abs Ø 20 cm 356MD20X, colonna doccia in ottone telescopica, altezza asta regolabile, con deviatore 330A, doccetta in abs a 3 funzioni 319MO, flessibile 150 cm.

Shower set including: exposed mixer with upper connection, abs Ø 20 cm shower head 356MD20X, telescopic brass shower column, with height-adjustable rod, with diverter 330A, 4-function abs hand shower 319MO, 150 cm flexible hose.

	CR	<input type="checkbox"/>	<input type="checkbox"/>
--	----	--------------------------	--------------------------

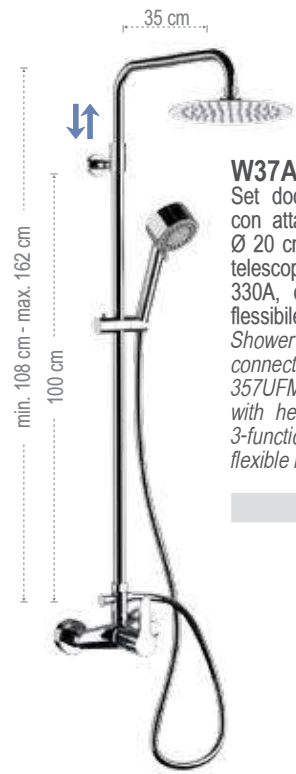

W37AUFM20
Set doccia composto da: miscelatore esterno con attacco superiore, soffione in acciaio inox Ø 20 cm 357UFM20X, colonna doccia in ottone telescopica, altezza asta regolabile, con deviatore 330A, doccetta in abs a 3 funzioni 319MO, flessibile 150 cm.

Shower set including: exposed mixer with upper connection, stainless steel Ø 20cm shower head 357UFM20X, telescopic brass shower column, with height-adjustable rod, with diverter 330A, 3-function abs hand shower 319MO, 150 cm flexible hose.

	CR	<input type="checkbox"/>	<input type="checkbox"/>
--	----	--------------------------	--------------------------



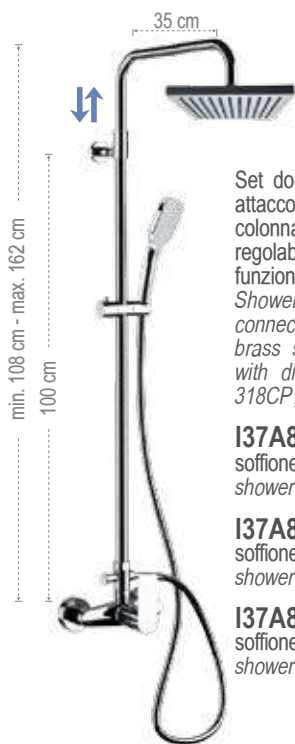

Set doccia composto da: miscelatore esterno con attacco superiore, soffione in abs 356SD20X, colonna doccia in ottone telescopica, altezza asta regolabile, con deviatore 330A, doccetta in abs con 3 funzioni 318CP, flessibile 150 cm.

Shower set including: exposed mixer with upper connection, abs shower head 356SD20X, telescopic brass shower column, with height-adjustable rod, with diverter 330A, 3-function abs hand shower 318CP, 150 cm flexible hose.

I37A8CPSD20

soffione 20x20 cm.
shower head 20x20 cm.

CR

I37A8CPSD25

soffione 25x25 cm.
shower head 25x25 cm.

CR

I37A8CPSD30

soffione 30x30 cm.
shower head 30x30 cm.

CR

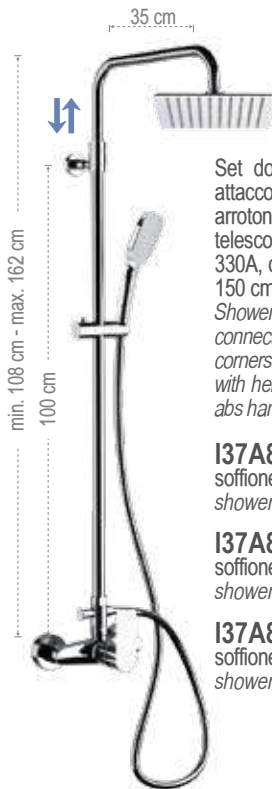

Set doccia composto da: miscelatore esterno con attacco superiore, soffione in acciaio inox con angoli arrotondati 357UFD20X, colonna doccia in ottone telescopica, altezza asta regolabile, con deviatore 330A, doccetta in abs con 3 funzioni 318CP, flessibile 150 cm.

Shower set including: exposed mixer with upper connection, stainless steel shower head with rounded corners 357UFD20X, telescopic brass shower column, with height-adjustable rod, with diverter 330A, 3-function abs hand shower 318CP, 150 cm flexible hose.

I37A8CPUFD20

soffione 20x20 cm.
shower head 20x20 cm.

CR

NO

I37A8CPUFD25

soffione 25x25 cm.
shower head 25x25 cm.

CR

NO

I37A8CPUFD30

soffione 30x30 cm.
shower head 30x30 cm.

CR

NO

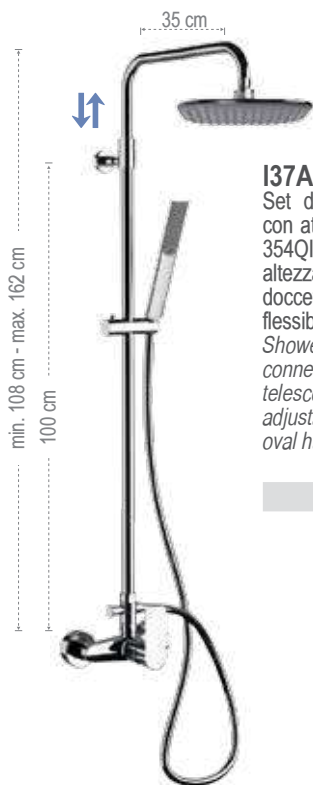

I37A7RV54QI

Set doccia composto da: miscelatore esterno con attacco superiore, soffione 20x20 cm in abs 354QIX, colonna doccia in ottone telescopica, altezza asta regolabile, con deviatore 330A, doccetta ovale in abs a 1 funzione 317RV, flessibile 150 cm.

Shower set including: exposed mixer with upper connection, abs 20x20 cm shower head 354QIX, telescopic brass shower column, with height-adjustable rod, with diverter 330A, 1-function abs oval hand shower 317RV, 150 cm flexible hose.

CR

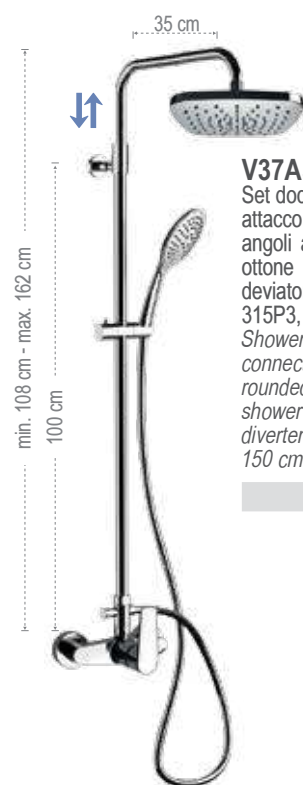

V37A5P3AD20

Set doccia composto da: miscelatore esterno con attacco superiore, soffione in abs 20x20cm con angoli arrotondati 356AD20X, colonna doccia in ottone telescopica, altezza asta regolabile, con deviatore 330A, doccetta in abs con 3 funzioni 315P3, flessibile 150 cm.

Shower set including: exposed mixer with upper connection, abs 20x20 cm shower head with rounded corners 356AD20X, telescopic brass shower column, with height-adjustable rod, with diverter 330A, 3-function abs hand shower 315P3, 150 cm flexible hose.

CR



COLONNE DOCCIA QUADRATE
SQUARED SHOWER COLUMNS



Q377AU

Set doccia composto da: miscelatore esterno con attacco superiore, soffione in ottone 20x20cm 359SSX, colonna doccia quadrata in ottone con deviatore 330S, doccetta quadrata in ottone a 1 funzione 317SS, flessibile 150 cm.

Shower set including: exposed mixer with upper connection, brass shower head 20x20cm 359SSX, square brass shower column with diverter 330S, 1-function brass square hand shower 317SS, 150 cm flexible hose.



Q37XL7AU

Set doccia composto da: miscelatore esterno con attacco superiore, soffione in ottone 35x35cm 359SSXLX, colonna doccia quadrata in ottone con deviatore 330S, doccetta quadrata in ottone a 1 funzione 317SS, flessibile 150 cm.

Shower set including: exposed mixer with upper connection, brass shower head 35x35cm 359SSXLX, square brass shower column with diverter 330S, 1-function brass square hand shower 317SS, 150 cm flexible hose.

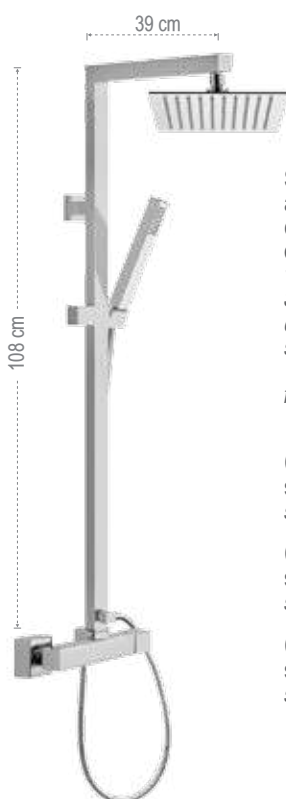

Set doccia composto da: miscelatore esterno con attacco superiore, soffione in acciaio inox 357UFS20, colonna doccia quadrata in ottone con deviatore 330S, doccetta quadrata in ABS, 1 funzione 317SD, flessibile 150 cm.

Shower set including: exposed mixer with upper connection, stainless steel shower head 357UFS20, square brass shower column with diverter 330S, 1-function abs square hand shower 317SD, 150 cm flexible hose.

Q377SDUFS20

soffione 20x20 cm.
shower head 20x20 cm.



Q377SDUFS25

soffione 25x25 cm.
shower head 25x25 cm.



Q377SDUFS30

soffione 30x30 cm.
shower head 30x30 cm.





Q377SS

BORDO VASCA
DECK BATH MIXERS

DOCCHETTE
HANDSHOWERS

SALISCENDI
SLIDING RAILS

PANNELLI DOCCIA
SHOWER PANELS

BOCCHE
SPOUTS

SOFFIONI
SHOWER HEADS

CROMOTERAPIA
COLORTHERAPY

KIT WELLNESS
WELLNESS KIT

COLONNE DOCCIA
SHOWER COLUMNS

TERMOSTATICI
THERMOSTATICS

A PULSANTE
PUSH-BUTTON

BOX INCASSO
BUILT-IN BOX

COLONNE DOCCIA CLASSICHE
CLASSIC SHOWER COLUMNS



09LIB20

Gruppo vasca-doccia tradizionale, con colonna saliscendi, con deviatore, doccetta, flessibile e soffione doccia. Tutto in ottone.

Traditional 2-handle shower/bathtub faucet with sliding rail column with diverter and handshower, with shower hose and shower head. All in chrome plated brass.

CR

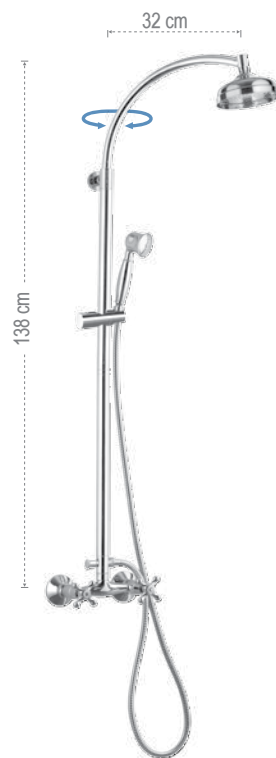

37LIRB20

Gruppo doccia con colonna saliscendi e deviatore, completa di doccetta con flessibile e soffione, tutto in ottone cromato.

Shower wall mounted mixer with deluxe sliding rail column and diverter, complete with handshower, flexible hose and shower head, all in c.p. brass

CR



COMPLEMENTI - COMPLEMENT ITEMS



330STU10

Tubo in ottone per estensione dell'altezza della colonna art. 329S e 330S, lunghezza cm 10 cm.

Brass pipe for the extension of height of columns art 329S and 330S, length 10 cm.

CR



330STU20

Tubo in ottone per estensione dell'altezza della colonna art. 329S e 330S, lunghezza cm 20 cm.

Brass pipe for the extension of height of columns art 329S and 330S, length 20 cm.

CR



330FLBC

Flessibile doccia per collegamento colonna doccia-miscelatore, attacco 1/2Fx1/2F, lunghezza cm 50.

Flexible shower hose for connection shower column - mixer, connection 1/2Fx1/2F, length cm 50.

CR

**330FTU20**

Tubo in ottone per estensione dell'altezza delle colonne 330F e 330L, lunghezza cm 20, Ø 22 mm.

Brass pipe for the extension of height of columns art 330F and 330L, length 20 cm for pipe Ø 22 mm.

CR

**330NTU20**

Tubo in ottone per estensione dell'altezza delle colonne art. 330N lunghezza cm 20, Ø 25 mm.

Brass pipe for the extension of height of columns art. 330N length 20 cm for pipe Ø 25 mm.

CR

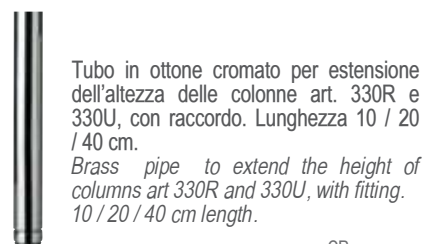

Tubo in ottone cromato per estensione dell'altezza delle colonne art. 330R e 330U, con raccordo. Lunghezza 10 / 20 / 40 cm.

Brass pipe to extend the height of columns art 330R and 330U, with fitting. 10 / 20 / 40 cm length.

CR

330RTU10

10 cm

CR

330RTU20

20 cm

CR

330RTU40

40 cm

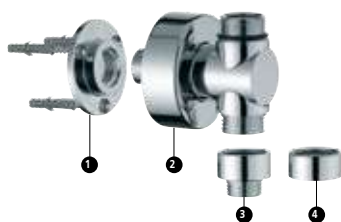
**330RA**

Presca d'acqua - supporto a muro per colonne doccia, multifunzione:

- supporto a muro alto
- presa d'acqua a muro alta
- presa d'acqua dal basso con tappo
- presa d'acqua dal basso per flessibile

Componenti:

1. Fissaggio a muro
2. Corpo principale
3. Riduzione 3/4Fx1/2M
4. Tappo 3/4F

Water punch outlet and wall bearing for shower columns, multifunction:

- high wall bearing
- high punch for water outlet
- low punch for water outlet with closing plug
- low punch for outlet water, for shower flexible hose

Components:

1. Wall fixing
2. Central body
3. Reduction 3/4Fx1/2M
4. Closing plug 3/4F CR

**330DEV**

Deviatore con molla e fermo, per colonne, 3/4Mx3/4Fx1/2M.

Diverter with spring and stop, for columns, 3/4M x 3/4F x 1/2M.

CR

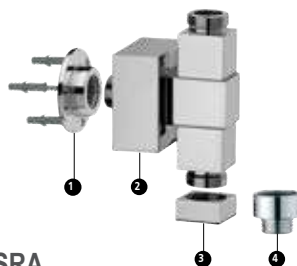
**330SRA**

Presca d'acqua - supporto a muro per colonne doccia, multifunzione:

- supporto a muro alto
- presa d'acqua a muro alta
- presa d'acqua dal basso con tappo
- presa d'acqua dal basso per flessibile

Componenti:

1. Fissaggio a muro
2. Corpo principale
3. Riduzione 3/4Fx1/2M
4. Tappo 3/4F

Water punch outlet and wall bearing for shower columns, multifunction:

- high wall bearing
- high punch for water outlet
- low punch for water outlet with closing plug
- low punch for outlet water, for shower flexible hose

Components:

1. Wall fixing
2. Central body
3. Reduction 3/4Fx1/2M
4. Closing plug 3/4F CR

**330SDEV**

Deviatore con molla e fermo, per colonne, 3/4Mx3/4Fx1/2M.

Squared diverter for shower columns, with spring and stop, 3/4M x 3/4F x 1/2M.

CR

**330NRA**

Supporto per colonne da 3/4 con deviatore integrato e presa acqua inferiore 1/2.

Support for 3/4 shower column with integrated diverter and lower water punch 1/2.

CR

**316A**

Deviatore doccia per canna livello Ø18mm 3/4Mx3/4Fx1/2M, tipo automatico con molla.

C.P. diverter for shower, for sink spout Ø 18mm, 3/4Mx3/4Fx1/2M, automatic type,

CR

**330FSU**

Supporto inferiore per colonna da 3/4 con passaggio acqua esterno tramite collegamento 1/2.

Lower holder for column 3/4 with external water connector 1/2,

CR

KIT WELLNESS - WELLNESS KIT

KIT WELLNESS WELLNESS KIT



I KIT WELLNESS di Remer Rubinetterie sono soluzioni complete di rubinetteria studiate per arredare gli interni doccia. Le composizioni doccia si differenziano per miscelazione tradizionale o termostatica oltre che per forme, dimensioni, funzioni e numero di uscite acqua gestite. E' così possibile personalizzare ogni bagno progettando un interno doccia a misura delle singole preferenze.

WELLNESS KITS by Remer Rubinetterie are complete faucet solutions designed to furnish shower interiors. The shower compositions differ in traditional or thermostatic mixing as well as in shapes, dimensions, functions and number of managed water outlets. It is thus possible to customize each bathroom by designing a shower interior tailored to individual preferences.



SETS02D20

BORDO VASCA
DECK BATH MIXERS

DOCCHETTE
HANDSHOWERS

SALISCENDI
SLIDING RAILS

PANNELLI DOCCIA
SHOWER PANELS

BOCCHE
SPOUTS

SOFFIONI
SHOWER HEADS

CROMOTERAPIA
COLOR THERAPY

KIT WELLNESS
WELLNESS KIT

COLONNE DOCCIA
SHOWER COLUMNS

TERMOSTATICI
THERMOSTATICS

A PULSANTE
PUSH-BUTTON

BOX INCASSO
BUILT-IN BOX

KIT DOCCIA SENZA MISCELATORE - *SHOWER KIT WITHOUT SHOWER MIXERS*

2 VIEWAYS



SETS028MPL30EC20

Set per doccia, composto da: attacco presa acqua a muro con supporto per doccetta, braccio a muro in ottone 30cm, soffione Ø 20 cm in abs cromato, doccetta in ABS a 3 funzioni con pulsante per il cambio dell'intensità, flessibile 150cm. Set da completare con un miscelatore a incasso con deviatore (NON incluso).

Set for shower, including: wall water connection with hand shower holder, 30cm brass wall arm, Ø 20cm abs shower head, 3-function abs hand shower with button for jets mode switching, 150cm flexible hose. Set to be completed with a built-in mixer with diverter (not included).

CR



SETS028CPL30EC20

Set per doccia, composto da: attacco presa acqua a muro con supporto per doccetta, braccio a muro in ottone 30cm, soffione 20x20cm in abs con angoli arrotondati, doccetta in ABS a 3 funzioni con pulsante per il cambio dell'intensità, flessibile 150cm. Set da completare con un miscelatore a incasso con deviatore (NON incluso).

Set for shower, including: wall water connection with hand shower holder, 30cm brass wall arm, 20x20cm c.p. abs shower head with rounded corners, 3-function abs hand shower with button for jets mode switching, 150cm flexible hose. Set to be completed with a built-in mixer with diverter (not included).



Set per doccia, composto da: attacco presa acqua a muro con supporto per doccetta, braccio a muro squadrato in ottone 30cm, soffione in abs, doccetta in ABS a 3 funzioni con pulsante per il cambio dell'intensità, flessibile 150cm. Set da completare con un miscelatore a incasso con deviatore (NON incluso).

Set for shower, including: wall water connection with hand shower holder, 30cm squared brass wall arm, abs shower head, 3-function abs hand shower with button for jets mode switching, 150cm flexible hose. Set to be completed with a built-in mixer with diverter (not included).

SDS02Q8CPSD20Q

soffione 20x20 cm
shower head 20x20 cm.

CR

SDS02Q8CPSD25Q

soffione 25x25 cm.
shower head 25x25 cm.

CR

SDS02Q8CPSD30Q

soffione 30x30 cm.
shower head 30x30 cm.

CR



Set per doccia, composto da: attacco presa acqua a muro con supporto per doccetta, braccio a muro in ottone 30cm, soffione in abs, doccetta in ABS a 3 funzioni con pulsante per il cambio dell'intensità, flessibile 150cm. Set da completare con un miscelatore a incasso con deviatore (NON incluso).

Set for shower, including: wall water connection with hand shower holder, 30cm brass wall arm, abs shower head, 3-function abs hand shower with button for jets mode switching, 150cm flexible hose. Set to be completed with a built-in mixer with diverter (not included).

SDS02L8MPMD20

soffione Ø 20 cm
shower head Ø 20 cm.

CR

SDS02L8MPMD25

soffione Ø 25 cm.
shower head Ø 25 cm.

CR

SDS02L8MPMD30

soffione Ø 30 cm.
shower head Ø 30 cm.

CR





Set per doccia, composto da: attacco presa acqua a muro con supporto per doccetta, braccio a muro in ottone 30cm, soffione tondo ultra piatto in acciaio INOX lucidato a specchio, doccetta in abs a 1 funzione, flessibile 150cm.

Set da completare con un miscelatore a incasso con deviatore (NON incluso).

Set for shower, including: wall water connection with hand shower holder, 30cm brass wall arm, ultra-flat round shower head in mirror-polished stainless steel, 1-function abs hand shower, 150cm flexible hose. Set to be completed with a built-in mixer with diverter (not included).

SETS02D20

soffione Ø 20 cm
shower head Ø 20 cm.

CR

SETS02D25

soffione Ø 25 cm.
shower head Ø 25 cm.

CR

SETS02D30

soffione Ø 30 cm.
shower head Ø 30 cm.

CR



Set per doccia, composto da: attacco presa acqua a muro con supporto per doccetta, braccio a muro squadrate in ottone 30cm, soffione quadrato ultra piatto in acciaio INOX lucidato a specchio, doccetta quadrata in abs a 1 funzione, flessibile 150cm. Set da completare con un miscelatore a incasso con deviatore (NON incluso).

Set for shower, including: wall water connection with hand shower holder, 30cm squared brass wall arm, squared ultra-flat shower head in mirror-polished stainless steel, 1-function abs squared hand shower, 150cm flexible hose. Set to be completed with a built-in mixer with diverter (not included).

SETS02Q7SD20Q

soffione 20x20 cm
shower head 20x20 cm.

CR

SETS02Q7SD25Q

soffione 25x25 cm.
shower head 25x25 cm.

CR

SETS02Q7SD30Q

soffione 30x30 cm.
shower head 30x30 cm.

CR



Set per doccia, composto da: attacco presa acqua a muro con supporto per doccetta, braccio a muro in ottone 30cm, soffione tondo in abs, doccetta in abs a 1 funzione, flessibile 150cm. Set da completare con un miscelatore a incasso con deviatore (NON incluso).

Set for shower, including: wall water connection with hand shower holder, 30cm brass wall arm, round abs shower head, 1-function abs hand shower, 150cm flexible hose.

Set to be completed with a built-in mixer with diverter (not included).

SDS02L7MDMD20

soffione Ø20 cm.
shower head Ø20 cm.

CR

SDS02L7MDMD24

soffione Ø25 cm.
shower head Ø25 cm.

CR

SDS02L7MDMD30

soffione Ø30 cm.
shower head Ø30 cm.

CR



Set per doccia, composto da: attacco presa acqua a muro con supporto per doccetta, braccio a muro squadrate in ottone 30cm, soffione quadrato in abs, doccetta quadrata in abs a 1 funzione, flessibile 150cm.

Set da completare con un miscelatore a incasso con deviatore (NON incluso).

Set for shower, including: wall water connection with hand shower holder, 30cm squared brass wall arm, squared abs shower head, 1-function abs squared hand shower, 150cm flexible hose.

Set to be completed with a built-in mixer with diverter (not included).

SETS02SD20

soffione 20x20 cm.
shower head 20x20 cm.

CR

SETS02SD25

soffione 25x25 cm.
shower head 25x25 cm.

CR

SETS02SD30

soffione 30x30 cm.
shower head 30x30 cm.

CR





Set per doccia, composto da: attacco presa acqua a muro con supporto per doccetta, braccio a muro in ottone 30cm, soffione ultra piatto tondo in acciaio INOX lucidato a specchio, doccetta in ottone a 1 funzione, flessibile 150cm.

Set da completare con un miscelatore a incasso con deviatore (NON incluso).

Set for shower, including: wall water connection with hand shower holder, 30cm brass wall arm, ultra-flat round shower head in mirror-polished stainless steel, 1-function brass hand shower, 150cm flexible hose.

Set to be completed with a built-in mixer with diverter (not included).

SDS02L7MCUFM20NO

soffione Ø 20 cm
shower head Ø 20 cm.

CR NO

SDS02L7MCUFM25NO

soffione Ø 25 cm.
shower head Ø 25 cm.

CR NO

SDS02L7MCUFM30NO

soffione Ø30 cm.
shower head Ø 30 cm.

CR NO



Set per doccia, composto da: attacco presa acqua a muro con supporto per doccetta, braccio a muro in ottone 30cm, soffione ultra piatto quadrato in acciaio INOX lucidato a specchio, doccetta in ottone a 1 funzione, flessibile 150cm.

Set da completare con un miscelatore a incasso con deviatore (NON incluso).

Set for shower, including: wall water connection with hand shower holder, 30cm brass wall arm, ultra-flat squared shower head in mirror-polished stainless steel, 1-function brass hand shower, 150cm flexible hose.

Set to be completed with a built-in mixer with diverter (not included).

SDS02L7AUUFS20QNO

soffione 20x20 cm
shower head 20x20 cm.

CR NO

SDS02L7AUUFS25QNO

soffione 25x25 cm.
shower head 25x25 cm.

CR NO

SDS02L7AUUFS30QNO

soffione 30x30 cm.
shower head 30x30 cm.

CR NO





Set per doccia, composto da: attacco presa acqua a muro con supporto per doccetta, braccio a muro in ottone 30cm, soffione ultra piatto in acciaio INOX lucidato a specchio, doccetta in ABS a 3 funzioni con pulsante per il cambio dell'intensità, flessibile 150cm. Set da completare con un miscelatore a incasso con deviatore (NON incluso).

Set for shower, including: wall water connection with hand shower holder, 30cm brass wall arm, ultra-flat Ø20cm shower head in mirror-polished stainless steel, 3-function abs hand shower with button for jets mode switching, 150cm flexible hose. Set to be completed with a built-in mixer with diverter (not included).

SDS02L8MPUFM20

soffione Ø 20 cm
shower head Ø 20 cm.

CR	NO
----	----

SDS02L8MPUFM25

soffione Ø 25 cm.
shower head Ø 25 cm.

CR	NO
----	----

SDS02L8MPUFM30

soffione Ø30 cm.
shower head Ø 30 cm.

CR	NO
----	----



Set per doccia, composto da: attacco presa acqua a muro con supporto per doccetta, braccio a muro in ottone 30cm, soffione ultra piatto lucidato a specchio con angoli arrotondati, doccetta in ABS a 3 funzioni con pulsante per il cambio dell'intensità, flessibile 150cm. Set da completare con un miscelatore a incasso con deviatore (NON incluso).

Set for shower, including: wall water connection with hand shower holder, 30cm brass wall arm, ultra-flat shower head in mirror-polished stainless steel with rounded corners, 3-function abs hand shower with button for jets mode switching, 150cm flexible hose. Set to be completed with a built-in mixer with diverter (not included).

SDS02L8CPUFD20

soffione 20x20 cm
shower head 20x20 cm.

CR	NO
----	----

SDS02L8CPUFD25

soffione 25x25 cm.
shower head 25x25 cm.

CR	NO
----	----

SDS02L8CPUFD30

soffione 30x30 cm.
shower head 30x30 cm.

CR	NO
----	----



Set per doccia, composto da: attacco presa acqua a muro con supporto per doccetta, braccio a muro squadrato in ottone 30cm, soffione 20x20cm in ottone, doccetta quadrata in ottone a 1 funzione, flessibile 150cm. Set da completare con un miscelatore a incasso con deviatore (NON incluso).

Set for shower, including: wall water connection with hand shower holder, 30cm brass wall arm, 20x20cm brass shower head, 1-function brass hand shower, 150cm flexible hose. Set to be completed with a built-in mixer with diverter (not included).

SDS02Q7AU9SSQ

Con soffione 20x20 cm e braccio a parete 30cm
With shower head 20x20 cm and wall arm 30 cm.

CR	FIN 1	FIN 2
----	-------	-------

SDS02Q7AUSSLQ

Con soffione 30x30 cm e braccio a parete 30cm
With shower head 30x30 cm and wall arm 30 cm.

CR	FIN 1	FIN 2
----	-------	-------



Set per doccia, composto da: attacco presa acqua a muro con supporto per doccetta, braccio a muro in ottone 30cm, soffione in ottone, doccetta in ottone a 1 funzione, flessibile 150cm. Set da completare con un miscelatore a incasso con deviatore (NON incluso).

Set for shower, including: wall water connection with hand shower holder, 30cm brass wall arm, brass shower head, 1-function brass hand shower, 150cm flexible hose. Set to be completed with a built-in mixer with diverter (not included).

SDS02L7MCM20

Con soffione Ø 20 cm e braccio a parete 30cm
With shower head Ø 20 cm and wall arm 30 cm.

CR	FIN 1	FIN 2
----	-------	-------

SDS02L7MCM30

Con soffione Ø 30 cm e braccio a parete 30cm
With shower head Ø 30 cm and wall arm 30 cm.

CR	FIN 1	FIN 2
----	-------	-------



BOX INCASSO
BUILT-IN BOX
A PULSANTE
PUSH-BUTTON
THERMOSTATICI
THERMOSTATICS
COLONNE DOCCIA
SHOWER COLUMNS
KIT WELLNESS
WELLNESS KIT
CROMOTERAPIA
COLOR THERAPY
SOFFIONI
SHOWER HEADS
BOCCHE
SPOUTS
PANNELLI DOCCIA
SHOWER PANELS
SALISCENDI
SLIDING RAILS
DOCCETTE
HANDSHOWERS
BORDO VASCA
DECK BATH MIXERS

CON SOFFIONE A PARETE - WITH WALL MOUNTING SHOWER HEAD

Disponibili, su richiesta, in finitura;
Available, on request, in finish;



SDS027MCMCA

Set per doccia, composto da: attacco presa acqua a muro con supporto per doccetta, soffione a parete in acciaio inox lucidato a specchio con getto pioggia e cascata, doccetta in ottone 1 funzione, flessibile opaco in PVC 150cm. Set da completare con un miscelatore a incasso a 3 vie (NON incluso).

Set for shower, including: wall water connection with hand shower holder, wall-mounted shower head in mirror-polished stainless steel with rain and waterfall jets, 1-function brass hand shower, 150cm matt PVC flexible hose. Set to be completed with a 3-way built-in mixer (not included).



CR

NO-BO

XV

BG



SDS027AUSSCAQ

Set per doccia, composto da: attacco presa acqua a muro con supporto per doccetta, soffione a parete in acciaio inox lucidato a specchio con getto pioggia e cascata, doccetta in ottone 1 funzione, flessibile opaco in PVC 150cm. Set da completare con un miscelatore a incasso a 3 vie (NON incluso).

Set for shower, including: wall water connection with hand shower holder, wall-mounted shower head in mirror-polished stainless steel with rain and waterfall jets 1-function brass hand shower, 150cm matt PVC flexible hose. Set to be completed with a 3-way built-in mixer (not included).



CR

NO-BO

XV

BG



SDS027MCUFMCA

Set per doccia, composto da: attacco presa acqua a muro con supporto per doccetta, soffione a parete ultra-sottile in acciaio inox lucidato a specchio con getto pioggia e cascata, doccetta in ABS a 1 funzione, flessibile opaco in PVC 150cm. Set da completare con un miscelatore a incasso a 3 vie (NON incluso).

Set for shower, including: wall water connection with hand shower holder, ultra-flat wall-mounted shower head in mirror-polished stainless steel with rain and waterfall jets, 1-function abs hand shower, 150cm matt PVC flexible hose. Set to be completed with a 3-way built-in mixer (not included).



CR

NO-BO

XV

BG



SDS027AUUFCAQ

Set per doccia, composto da: attacco presa acqua a muro con supporto per doccetta, soffione a parete ultra-sottile in acciaio inox lucidato a specchio con getto pioggia e cascata, doccetta quadrata in ABS a 1 funzione, flessibile opaco in PVC 150cm. Set da completare con un miscelatore a incasso a 3 vie (NON incluso).

Set for shower, including: wall water connection with hand shower holder, ultra-flat wall-mounted shower head in mirror-polished stainless steel with rain and waterfall jets, 1-function squared abs hand shower, 150cm matt PVC flexible hose. Set to be completed with a 3-way built-in mixer (not included).



CR

NO-BO

XV

BG



2 VIE
WAYS**SDS027MCMM**

Set per doccia, composto da: attacco presa acqua a muro con supporto per doccetta, soffione a parete in acciaio inox lucidato a specchio con getto pioggia, doccetta in ottone 1 funzione, flessibile opaco in PVC 150cm. Set da completare con un miscelatore a incasso a 3 vie (NON incluso).

Set for shower, including: wall water connection with hand shower holder, wall-mounted shower head in mirror-polished stainless steel with rain jets, 1-function brass hand shower, 150cm matt PVC flexible hose. Set to be completed with a 3-way built-in mixer (not included).



CR

NO-BO

XV

BG

**SDS027AUSSQ**

Set per doccia, composto da: attacco presa acqua a muro con supporto per doccetta, soffione a parete in acciaio inox lucidato a specchio con getto pioggia, doccetta in ottone 1 funzioni, flessibile opaco in PVC 150cm. Set da completare con un miscelatore a incasso a 3 vie (NON incluso).

Set for shower, including: wall water connection with hand shower holder, wall-mounted shower head in mirror-polished stainless steel with rain jets 1-function brass hand shower, 150cm matt PVC flexible hose. Set to be completed with a 3-way built-in mixer (not included).



CR

NO-BO

XV

BG

**SDS027MCUFM**

Set per doccia, composto da: attacco presa acqua a muro con supporto per doccetta, soffione a parete ultra-sottile in acciaio inox lucidato a specchio con getto pioggia, doccetta in ABS a 1 funzione, flessibile opaco in PVC 150cm. Set da completare con un miscelatore a incasso a 3 vie (NON incluso).

Set for shower, including: wall water connection with hand shower holder, ultra-flat wall-mounted shower head in mirror-polished stainless steel with rain jets, 1-function abs hand shower, 150cm matt PVC flexible hose. Set to be completed with a 3-way built-in mixer (not included).



CR

NO-BO

XV

BG

**SDS027AUUFQ**

Set per doccia, composto da: attacco presa acqua a muro con supporto per doccetta, soffione a parete ultra-sottile in acciaio inox lucidato a specchio con getto pioggia, doccetta quadrata in ABS a 1 funzione, flessibile opaco in PVC 150cm. Set da completare con un miscelatore a incasso a 3 vie (NON incluso).

Set for shower, including: wall water connection with hand shower holder, ultra-flat wall-mounted shower head in mirror-polished stainless steel with rain jets, 1-function squared abs hand shower, 150cm matt PVC flexible hose. Set to be completed with a 3-way built-in mixer (not included).



CR

NO-BO

XV

BG



CON SOFFIONE A SOFFITTO - WITH CEILING SHOWER HEADS

Disponibili, su richiesta, in finitura;
Available, on request, in finish;



2 VIE
WAYS



SDS027MCEFM34

Set per doccia, composto da: attacco presa acqua a muro con supporto per doccetta, soffione a parete in acciaio inox lucidato a specchio, doccetta in ottone 1 funzione, flessibile opaco in PVC 150cm. Set da completare con un miscelatore a incasso con deviatore (NON incluso).

Set for shower, including: wall water connection with hand shower holder, wall-mounted shower head in mirror-polished stainless steel, 14-function brass hand shower, 150cm flexible hose. Set to be completed with a built-in mixer with diverter (not included).



CR

NO-BO

XV

BG

SDS027AUEFS34Q

Set per doccia, composto da: attacco presa acqua a muro con supporto per doccetta, soffione a parete in acciaio inox lucidato a specchio, doccetta in ABS a 4 funzioni con pulsante per il cambio dell'intensità, flessibile opaco in PVC 150cm. Set da completare con un miscelatore a incasso con deviatore (NON incluso).

Set for shower, including: wall water connection with hand shower holder, wall-mounted shower head in mirror-polished stainless steel, 4-function abs hand shower with button for jets mode switching, 150cm flexible hose. Set to be completed with a built-in mixer with diverter (not included).



CR

NO-BO

XV

BG



SDS027MCEFM44

Set per doccia, composto da: attacco presa acqua a muro con supporto per doccetta, soffione a parete ultra-sottile in acciaio inox lucidato a specchio, doccetta in ottone a 1 funzione, flessibile opaco in PVC 150cm.

Set da completare con un miscelatore a incasso con deviatore (NON incluso).

Set for shower, including: wall water connection with hand shower holder, ultra-flat wall-mounted shower head in mirror-polished stainless steel, 1-function brass hand shower, 150cm matt PVC flexible hose.

Set to be completed with a built-in mixer with diverter (not included).



CR

NO-BO

XV

BG

SDS027AUEFS44Q

Set per doccia, composto da: attacco presa acqua a muro con supporto per doccetta, soffione a parete ultra-sottile in acciaio inox lucidato a specchio, doccetta quadrata in ABS a 1 funzione, flessibile opaco in PVC 150cm. Set da completare con un miscelatore a incasso con deviatore (NON incluso).

Set for shower, including: wall water connection with hand shower holder, ultra-flat wall-mounted shower head in mirror-polished stainless steel, 1-function squared abs hand shower, 150cm matt PVC flexible hose.

Set to be completed with a built-in mixer with diverter (not included).



CR

NO-BO

XV

BG



KIT DOCCIA SENZA MISCELATORE CON SALISCENDI
SHOWER KIT WITHOUT SHOWER MIXERS WITH SLIDING RAILS



Set per doccia, composto da: attacco presa acqua a muro e saliscendi, braccio a muro in ottone 30cm, soffione in ABS, doccetta in ABS a 1 funzione, flessibile 150cm. Set da completare con un miscelatore a incasso con deviatore (NON incluso).

Set for shower, including: wall water connection and sliding rails, 30cm brass wall arm, ABS shower head, ABS 1-function hand shower, 150cm flexible hose. Set to be completed with a built-in mixer with diverter (not included).

SDS01L7MDMD20 CR
 soffione Ø20 cm.
 shower head Ø20 cm.

SDS01L7MDMD25 CR
 soffione Ø25 cm.
 shower head Ø25 cm.

SDS01L7MDMD30 CR
 soffione Ø30 cm.
 shower head Ø30 cm.



Set per doccia, composto da: attacco presa acqua a muro e saliscendi, braccio a muro in ottone 30cm, soffione in ABS, doccetta in ABS a 1 funzione, flessibile 150cm. Set da completare con un miscelatore a incasso con deviatore (NON incluso).

Set for shower, including: wall water connection and sliding rails, 30cm brass wall arm, ABS shower head, ABS 1-function hand shower, 150cm flexible hose. Set to be completed with a built-in mixer with diverter (not included).

SDS01Q7SDSD20 CR
 soffione 20X20 cm.
 shower head 20X20 cm.

SDS01Q7SDSD25 CR
 soffione 25X25 cm.
 shower head 25X25 cm.

SDS01Q7SDSD30 CR
 soffione 30X30 cm.
 shower head 30X30 cm.



Set per doccia, composto da: attacco presa acqua a muro e saliscendi, braccio a muro in ottone 30cm, soffione in acciaio inox ultrapiatto, doccetta in ABS a 1 funzione, flessibile 150cm. Set da completare con un miscelatore a incasso con deviatore (NON incluso).

Set for shower, including: wall water connection and sliding rails, 30cm brass wall arm, stainless steel shower head, ABS 1-function hand shower, 150cm flexible hose. Set to be completed with a built-in mixer with diverter (not included).

SDS01L7MDUFM20 CR NO
 soffione Ø20 cm
 shower head Ø20 cm.

SDS01L7MDUFM25 CR NO
 soffione Ø25 cm.
 shower head Ø25 cm.

SDS01L7MDUFM30 CR NO
 soffione Ø30 cm.
 shower head Ø30 cm.



Set per doccia, composto da: attacco presa acqua a muro e saliscendi, braccio a muro in ottone 30cm, soffione in acciaio inox ultrapiatto, doccetta in ABS a 1 funzione, flessibile 150cm. Set da completare con un miscelatore a incasso con deviatore (NON incluso).

Set for shower, including: wall water connection and sliding rails, 30cm brass wall arm, stainless steel shower head, ABS 1-function hand shower, 150cm flexible hose. Set to be completed with a built-in mixer with diverter (not included).

SDS01Q7SDUFS20 CR NO
 soffione 20x20 cm
 shower head 20x20 cm.

SDS01Q7SDUFS25 CR NO
 soffione 25x25 cm.
 shower head 25x25 cm.

SDS01Q7SDUFS30 CR NO
 soffione 30x30 cm.
 shower head 30x30 cm.



BOX INCASSO
 BUILT-IN BOX
 A PULSANTE
 PUSH-BUTTON
 TERMOSTATICI
 THERMOSTATICS
 COLONNE DOCCIA
 SHOWER COLUMNS
 KIT WELLNESS
 WELLNESS KIT
 CROMOTERAPIA
 COLOR THERAPY
 SOFFIONI
 SHOWER HEADS
 BOCCHIE
 SPOUTS
 PANNELLI DOCCIA
 SHOWER PANELS
 SALISCENDI
 SLIDING RAILS
 DOCCETTE
 HANDSHOWERS
 BORDO VASCA
 DECK BATH MIXERS

KIT WELLNESS DISPONIBILE IN FINITURA
WELLNESS KIT AVAILABLE IN FINISHINGS



Set per doccia, composto da: attacco presa acqua a muro e saliscendi in ottone, braccio a muro in ottone 30cm, soffione in ottone, doccia a 1 funzione, flessibile 150cm. Set da completare con un miscelatore a incasso con deviatore (NON incluso).

Set for shower, including: wall water connection and brass sliding rails, 30cm brass wall arm, brass shower head, 1-function hand shower, 150cm flexible hose. Set to be completed with a built-in mixer with diverter (not included).

SDS01LO20

Con soffione Ø 20 cm e braccio a parete 30cm
With shower head Ø 20 cm and wall arm 30 cm.

CR

FIN 1

FIN 2



SDS01LO30

Con soffione Ø 30 cm e braccio a parete 30cm
With shower head Ø 30 cm and wall arm 30 cm.

CR

FIN 1

FIN 2

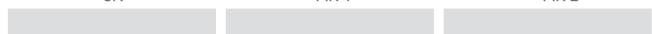

Set per doccia, composto da: attacco presa acqua a muro e saliscendi in ottone, braccio a muro in ottone 30cm, soffione in ottone, doccia a 1 funzione, flessibile 150cm. Set da completare con un miscelatore a incasso con deviatore (NON incluso).

Set for shower, including: wall water connection and brass sliding rails, 30cm brass wall arm, brass shower head, 1-function hand shower, 150cm flexible hose. Set to be completed with a built-in mixer with diverter (not included).

SDS01QO20

Con soffione 20x20 cm e braccio a parete 30cm
With shower head 20x20 cm and wall arm 30 cm.

CR

FIN 1

FIN 2

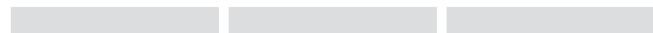

SDS01QO30

Con soffione 30x30 cm e braccio a parete 30cm
With shower head 30x30 cm and wall arm 30 cm.

CR

FIN 1

FIN 2

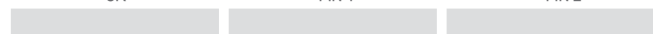

KIT WELLNESS QUADRATI - SQUARED WELLNESS KIT



Set doccia composto da: miscelatore a incasso con deviatore, soffione in abs 356SD20X, braccio quadrato in ottone 317S, presa acqua a muro, doccetta quadrata in ABS, 1 funzione 317SD, flessibile 150 cm.
Shower set including: built-in mixer with diverter, abs shower head 356SD20X, square brass arm 30 cm, square brass sliding rail 317S, wall water connection, 1-function abs square hand shower 317SD, 150 cm flexible hose.

**AU09S01SD20**

Con soffione da 20x20 cm e braccio a parete 30 cm.
With shower head 20x20 cm and wall arm 30 cm.

CR

AU09S01SD25

Con soffione da 25x25 cm e braccio a parete 30 cm.
With shower head 25x25 cm and wall arm 30 cm.

CR

AU09S01SD30

Con soffione da 30x30 cm e braccio a parete 30 cm.
With shower head 30x30 cm and wall arm 30 cm.

CR



Set doccia composto da: miscelatore a incasso con deviatore, soffione in abs 356SD20X, braccio quadrato in ottone 30 cm, presa acqua a muro con supporto doccetta, doccetta quadrata in ABS, 1 funzione 317SD, flessibile 150 cm.
Shower set including: built-in mixer with diverter, abs shower head 356SD20X, square brass arm 30 cm, wall water connection with shower holder, 1-function abs square hand shower 317SD, 150 cm flexible hose.

**AU09S02SD20**

Con soffione da 20x20 cm e braccio a parete 30 cm.
With shower head 20x20 cm and wall arm 30 cm.

CR

AU09S02SD25

Con soffione da 25x25 cm e braccio a parete 30 cm.
With shower head 25x25 cm and wall arm 30 cm.

CR

AU09S02SD30

Con soffione da 30x30 cm e braccio a parete 30 cm.
With shower head 30x30 cm and wall arm 30 cm.

CR



Set doccia composto da: miscelatore a incasso con deviatore, soffione in acciaio inox 357UFS20X, braccio quadrato in ottone 317S, presa acqua a muro, doccetta quadrata in ABS, 1 funzione 317SD, flessibile 150 cm.
Shower set including: built-in mixer with diverter, stainless steel shower head 357UFS20X, square brass arm 30 cm, square brass sliding rail 317S, wall water connection, 1-function abs square hand shower 317SD, 150 cm flexible hose.

**AU09S01UFS20**

Con soffione da 20x20 cm e braccio a parete 30 cm.
With shower head 20x20 cm and wall arm 30 cm.

CR

AU09S01UFS25

Con soffione da 25x25 cm e braccio a parete 30 cm.
With shower head 25x25 cm and wall arm 30 cm.

CR

AU09S01UFS30

Con soffione da 30x30 cm e braccio a parete 30 cm.
With shower head 30x30 cm and wall arm 30 cm.

CR



Set doccia composto da: miscelatore a incasso con deviatore, soffione in acciaio inox 357UFS20X, braccio quadrato in ottone 30 cm, presa acqua a muro con supporto doccetta, doccetta quadrata in ABS, 1 funzione 317SD, flessibile 150 cm.
Shower set including: built-in mixer with diverter, stainless steel shower head 357UFS20X, square brass arm 30 cm, wall water connection with shower holder, 1-function abs square hand shower 317SD, 150 cm flexible hose.

**AU09S02UFS20**

Con soffione da 20x20 cm e braccio a parete 30 cm.
With shower head 20x20 cm and wall arm 30 cm.

CR

AU09S02UFS25

Con soffione da 25x25 cm e braccio a parete 30 cm.
With shower head 25x25 cm and wall arm 30 cm.

CR

AU09S02UFS30

Con soffione da 30x30 cm e braccio a parete 30 cm.
With shower head 30x30 cm and wall arm 30 cm.

CR



AU09S02O20

Set doccia composto da: miscelatore a incasso con deviatore, soffione in ottone 20x20cm 359SSX, braccio quadrato in ottone 30 cm, presa acqua a muro con supporto doccetta, doccetta quadrata in ottone a 1 funzione 317SS, flessibile 150 cm.

Shower set including: built-in mixer with diverter, brass shower head 20x20cm 359SSX, square brass arm 30 cm, wall water connection with shower holder, 1-function brass square hand shower 317SS, 150 cm flexible hose.



AU09S02O30

con soffione da 30x30 cm.
with shower head 30x30 cm.



AU09S02SS

Set doccia composto da: miscelatore a incasso con deviatore, soffione a parete in acciaio inox con getto a pioggia 350SSX, presa acqua a muro con supporto doccetta, doccetta quadrata in ABS, 1 funzione 317SD, flessibile 150 cm.

Shower set including: built-in mixer with diverter, wall-mounted stainless steel shower head with rain jet 350SSX, wall water connection with shower holder, 1-function abs square hand shower 317SD, 150 cm flexible hose.



AU93S01SSCA

Set doccia composto da: miscelatore a incasso con deviatore a 3 vie, soffione a parete in acciaio inox con getto a pioggia e cascata 350SSCAX, saliscendi quadrato in ottone 317S, presa acqua a muro, doccetta quadrata in ottone a 1 funzione 317SS, flessibile 150 cm.

Shower set including: built-in mixer with 3-way diverter, wall mounted stainless steel shower head with rain and waterfall functions 350SSCAX, square brass sliding rail 317S, wall water connection, 1-function brass square hand shower 317SS, 150 cm flexible hose.



AU93S02SSCA

Set doccia composto da: miscelatore a incasso con deviatore a 3 vie, soffione a parete in acciaio inox con getto a pioggia e cascata 350SSCAX, presa acqua a muro con supporto doccetta, doccetta quadrata in ottone a 1 funzione 317SS, flessibile 150 cm.

Shower set including: built-in mixer with 3-way diverter, wall mounted stainless steel shower head with rain and waterfall functions 350SSCAX, wall water connection with shower holder, 1-function brass square hand shower 317SS, 150 cm flexible hose.

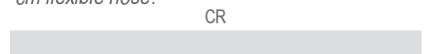

AU93S02UFCA

Come AU 93 S02 SSCA ma con soffione doccia ultrapiatto a parete in acciaio inox lucidato a specchio 2 getti, normale o cascata.

As AU 93 S02 SSCA but with ultra slim stainless steel mirror polished wall shower head 2 jets, normal and waterfall.



KIT WELLNESS TONDI - ROUND WELLNESS KIT

**X09S01**

Set doccia composto da: miscelatore a incasso con deviatore, soffione in acciaio inox Ø 20 cm 357UFM20X, braccio in ottone 30 cm, saliscendi minimale 317M, presa acqua a muro, doccetta minimale in ottone, 1 funzione 317MM, flessibile 150 cm.

Shower set including: built-in mixer with diverter, stainless steel Ø 20cm shower head 357UFM20X, brass arm 30 cm, minimal sliding rail 317M, wall water connection, 1-function brass hand shower 317MM, 150 cm flexible hose.

CR

**X09S02**

Set doccia composto da: miscelatore a incasso con deviatore, soffione in acciaio inox Ø 20 cm 357UFM20X, braccio in ottone 30 cm, presa acqua a muro con supporto doccetta, doccetta minimale in ottone, 1 funzione 317MM, flessibile 150 cm.

Shower set including: built-in mixer with diverter, stainless steel Ø 20cm shower head 357UFM20X, brass arm 30 cm, wall water connection with shower holder, 1-function brass hand shower 317MM, 150 cm flexible hose.

CR

**X96S02**

Set doccia composto da: miscelatore a incasso orizzontale con deviatore, soffione in acciaio inox Ø 20 cm 357UFM20X, braccio in ottone 30 cm, presa acqua a muro con supporto doccetta, doccetta minimale in ottone, 1 funzione 317MM, flessibile 150 cm.

Shower set including: horizontal built-in mixer with diverter, stainless steel Ø 20cm shower head 357UFM20X, brass arm 30 cm, wall water connection with shower holder, 1-function brass hand shower 317MM, 150 cm flexible hose.

CR

X09S01UFM25

Con soffione da 25x25 cm e braccio a parete 30 cm.
With shower head 25x25 cm and wall arm 30 cm.

CR

X09S02UFM25

Con soffione da 25x25 cm e braccio a parete 30 cm.
With shower head 25x25 cm and wall arm 30 cm.

CR

X96S02UFM25

Con soffione da 25x25 cm e braccio a parete 30 cm.
With shower head 25x25 cm and wall arm 30 cm.

CR

X09S01UFM30

Con soffione da 30x30 cm e braccio a parete 30 cm.
With shower head 30x30 cm and wall arm 30 cm.

CR

X09S02UFM30

Con soffione da 30x30 cm e braccio a parete 30 cm.
With shower head 30x30 cm and wall arm 30 cm.

CR

X96S02UFM30

Con soffione da 30x30 cm e braccio a parete 30 cm.
With shower head 30x30 cm and wall arm 30 cm.

CR

**X09S02EC20**

Set doccia composto da: miscelatore a incasso con deviatore, soffione in abs Ø 20cm 354EC20X, braccio in ottone 30 cm, presa acqua a muro con supporto doccetta, doccetta in abs, 1 funzione 317MD, flessibile 150 cm.

Shower set including: built-in mixer with diverter, abs Ø 20 cm shower head 354EC20X, brass arm 30 cm, wall water connection with shower holder, 1-function abs hand shower 317MD, 150 cm flexible hose.

CR

**X09S02MM**

Set doccia composto da: miscelatore a incasso con deviatore, soffione a parete in acciaio inox con getto a pioggia 350MMX, presa acqua a muro con supporto doccetta, doccetta in abs, 1 funzione 317MD, flessibile 150 cm.

Shower set including: built-in mixer with diverter, wall-mounted stainless steel shower head with rain jet 350MMX, wall water connection with shower holder, 1-function abs hand shower 317MD, 150 cm flexible hose.

CR





Set doccia composto da: miscelatore a incasso con deviatore, soffione in abs 356MD20X, braccio in ottone 30 cm, presa acqua a muro con supporto doccetta, doccetta in abs, 1 funzione 317MD, flessibile 150 cm.
 Shower set including: built-in mixer with diverter, abs shower head 356MD20X, brass arm 30 cm, wall water connection with shower holder, 1-function abs hand shower 317MD, 150 cm flexible hose.

X09S02MD20

con soffione da Ø20 cm e braccio a parete 30 cm.
 with shower head Ø20 cm and wall arm 30 cm.

CR

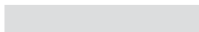

X09S02MD25

con soffione da Ø25 cm e braccio a parete 30 cm.
 with shower head Ø25 cm and wall arm 30 cm.

CR

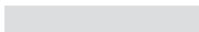

X09S02MD30

con soffione da Ø30 cm e braccio a parete 30 cm.
 with shower head Ø30 cm and wall arm 30 cm.

CR

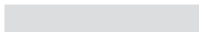

X09S02LO20

Set doccia composto da: miscelatore a incasso con deviatore, soffione in ottone Ø 20 cm 359MM20X, braccio in ottone 30 cm, presa acqua a muro con supporto doccetta, doccetta minimale in ottone, 1 funzione 317MM, flessibile 150 cm.

Shower set including: built-in mixer with diverter, brass shower head Ø 20 cm 359MM20X, brass arm 30 cm, wall water connection with shower holder, 1-function brass hand shower 317MM, 150 cm flexible hose.

CR

FIN 1

FIN 2

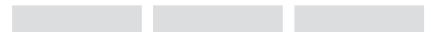

X09S02LO30

con soffione da Ø 30 cm.
 with shower head Ø 30 cm.

CR

FIN 1

FIN 2

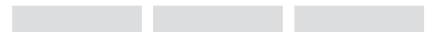

X93S01MMCA

Set doccia composto da: miscelatore a incasso con deviatore a 3 vie, soffione a parete in acciaio inox con getto a pioggia e cascata 350MMCA, saliscendi minimale 317M, presa acqua a muro, doccetta in abs, 1 funzione 317MD, flessibile 150 cm.

Shower set including: built-in mixer with 3-way diverter, wall mounted stainless steel shower head with rain and waterfall functions 350MMCA, minimal sliding rail 317M, wall water connection, 1-function abs hand shower 317MD, 150 cm flexible hose.

CR

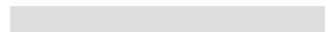

X93S02MMCA

Set doccia composto da: miscelatore a incasso con deviatore a 3 vie, soffione a parete in acciaio inox con getto a pioggia e cascata 350MMCA, presa acqua a muro con supporto doccetta, doccetta in abs, 1 funzione 317MD, flessibile 150 cm.

Shower set including: built-in mixer with 3-way diverter, wall mounted stainless steel shower head with rain and waterfall functions 350MMCA, wall water connection with shower holder, 1-function abs hand shower 317MD, 150 cm flexible hose.

CR

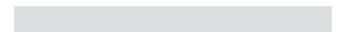

CON SOFFIONI A SOFFITTO - *CEILING SHOWER HEADS*

Set doccia composto da: miscelatore a incasso con deviatore a 2 vie, soffione a soffitto "easy fix" in acciaio inox 357EFM34, presa acqua a muro con supporto doccetta, doccetta in abs, 1 funzione 317MD, flessibile 150 cm.

Shower set including: built-in mixer with 2-way diverter, stainless steel ceiling "easy fix" shower head 357EFM34, wall water connection with shower holder, 1-function abs hand shower 317MD, 150 cm flexible hose.

X92S02EFM34

Soffione doccia EASY FIX in acciaio INOX lucidato a specchio Ø 34 cm.

Con getti anticalcare.

EASY FIX stainless steel mirror polished shower head Ø 34 cm. With antilimestone jets.

CR

X92S02EFM44

Soffione doccia EASY FIX in acciaio INOX lucidato a specchio Ø 44 cm.

Con getti anticalcare.

EASY FIX stainless steel mirror polished shower head Ø 44 cm. With antilimestone jets.

CR



X92S02EFM34

CROMOTERAPIA - COLORTHERAPY

CROMOTERAPIA COLORTHERAPY



Grazie all'utilizzo della tecnologia LED, i soffioni con funzioni di CROMOTERAPIA aggiungono al piacere della doccia il relax psico-fisico di una luce colorata. Le opzioni di cromoterapia, che includono selezione di luce bianca, selezione colori e cromoterapia automatica, possono essere gestite, a seconda del modello, tramite una pulsantiera installata a parete oppure tramite un telecomando wireless (verificare le specifiche tecniche di ogni singolo articolo).

Thanks to the use of LED technology, the shower heads with COLORTHERAPY functions add the psycho-physical relaxation of colored light to the pleasure of the shower. Colourtherapy options, including white light selection, color selection and automatic colortherapy, can be managed, depending on the model, via a wall-mounted push-button panel or via a wireless remote control (check the technical specifications of each item).



SOFFIONI A SOFFITTO "EASY FIX" CON FARETTO LED
 "EASY FIX" CEILING SHOWER HEADS WITH LED POTLIGHT

APPLICAZIONE A SOFFITTO "EASY FIX" - "EASY FIX" CEILING APPLICATION

1

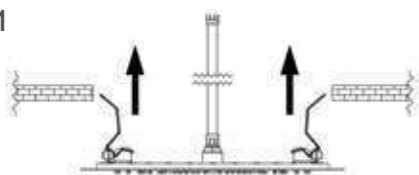

Per questa tipologia di soffione e con questo specifico sistema di fissaggio sono previste quattro molle per ogni soffione.

Nell'immagine 1 si evidenzia il primo movimento necessario:

caricare due molle vicine tra loro mettendole quasi in posizione verticale rispetto al soffione ed inserirle all'interno del foro precedentemente preparato.

Rilasciare le stesse delicatamente.

For this specic shower-head with this specific mounting system, four springs are installed on each head.

In picture 1, you shall see the first needed movement to activate them:

Spring-load two springs next to each other placing them almost vertically and insert them in the hole in the ceiling;

Release them gently;

2

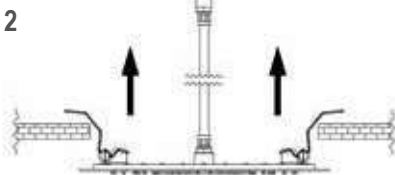

Mantenendo il soffione leggermente inclinato procedere caricando ed inserendo le rimanenti due molle come da immagine 2.

While keeping the shower head slightly inclined, proceed by spring-loading and inserting the two other springs as shown in picture 2.

3

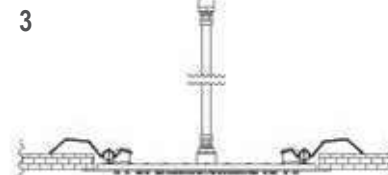

A questo punto rilasciare delicatamente le molle alla loro naturale tensione e, trattenendo esternamente il soffione, accompagnare lo stesso verso il totale appoggio al soffitto come da immagine 3.

Now release the springs back to their natural tension and, while holding the head from outside, guide it to its final position as shown in picture 3.



357REFR6030NG

Soffione rettangolare a soffitto 60x30 cm con tre uscite acqua: getto a pioggia, getto singolo laterale e nebulizzazione (2 uscite). Faretto per cromoterapia, ispezionabile, acciaio INOX lucidato a specchio. Sistema di montaggio "Easy Fix".

Rectangular ceiling shower head, 60x30 cm, with 3 water outlets: rain jet, lateral single jet and nebulization (2 outlets). Spotlight for colourtherapy, mirror polished stainless steel. "Easy Fix" mounting system..

CR



357REFR6030G

Soffione rettangolare a soffitto 60x30 cm con due uscite acqua: getto a pioggia e getto singolo laterale. Faretto per cromoterapia, ispezionabile, acciaio INOX lucidato a specchio. Sistema di montaggio "Easy Fix".

Rectangular ceiling shower head, 60x30 cm, with 2 water outlets: rain jet and lateral single jet. Spotlight for colourtherapy, mirror polished stainless steel. "Easy Fix" mounting system.

CR



357REFR6030CG

Soffione rettangolare a soffitto 60x30 cm con tre uscite acqua: getto a pioggia, getto cascata e getto singolo laterale. Faretto per cromoterapia, ispezionabile, acciaio INOX lucidato a specchio. Sistema di montaggio "Easy Fix".

Rectangular ceiling shower head, 60x30 cm, with 3 water outlets: rain jet, waterfall jet and lateral single jet. Spotlight for colourtherapy, mirror polished stainless steel. "Easy Fix" mounting system

CR

**357REFS34**

Soffione quadrato a soffitto 34x34 cm con getto a pioggia e faretto per cromoterapia, ispezionabile, acciaio INOX lucidato a specchio. Sistema di montaggio "Easy Fix". Include pulsantiera a parete per comandi luce.

Square ceiling shower head, 34x34 cm, with rain jet and spotlight for colourtherapy, mirror polished stainless steel. "Easy Fix" mounting system. Wall push-button panel for light controls included.



CR

**357REFS44**

Soffione quadrato a soffitto 44x44 cm con getto a pioggia e faretto per cromoterapia, ispezionabile, acciaio INOX lucidato a specchio. Sistema di montaggio "Easy Fix". Include pulsantiera a parete per comandi luce.

Square ceiling shower head, 44x44 cm, with rain jet and spotlight for colourtherapy, mirror polished stainless steel. "Easy Fix" mounting system. Wall push-button panel for light controls included.



CR

**357REFM34**

Soffione tondo a soffitto Ø34 cm con getto a pioggia e faretto per cromoterapia, ispezionabile, acciaio INOX lucidato a specchio. Sistema di montaggio "Easy Fix". Include pulsantiera a parete per comandi luce.

Round ceiling shower head, Ø34 cm, with rain jet and spotlight for colourtherapy, mirror polished stainless steel. "Easy Fix" mounting system. Wall push-button panel for light controls included.

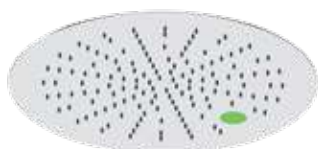

CR

**357REFM44**

Soffione tondo a soffitto Ø44 cm con getto a pioggia e faretto per cromoterapia, ispezionabile, acciaio INOX lucidato a specchio. Sistema di montaggio "Easy Fix". Include pulsantiera a parete per comandi luce.

Round ceiling shower head, Ø44 cm, with rain jet and spotlight for colourtherapy, mirror polished stainless steel. "Easy Fix" mounting system. Wall push-button panel for light controls included.

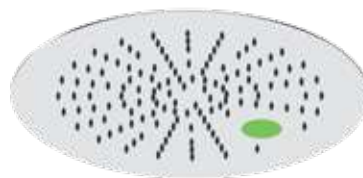

CR

2 VIE WAYS

**357REFM44G**

Soffione tondo a soffitto Ø44 cm con due uscite acqua: getto a pioggia e getto singolo centrale. Faretto per cromoterapia, ispezionabile, acciaio INOX lucidato a specchio. Sistema di montaggio "Easy Fix". Include pulsantiera a parete per comandi luce.

Round ceiling shower head, Ø44 cm, with 2 water outlets: rain jet and central single jet. Spotlight for colourtherapy, mirror polished stainless steel. "Easy Fix" mounting system. Wall push-button panel for light controls included.



CR

**357REFS44G**

Soffione quadrato a soffitto 44x44 cm con due uscite acqua: getto a pioggia e getto singolo centrale. Faretto per cromoterapia, ispezionabile, acciaio INOX lucidato a specchio. Sistema di montaggio "Easy Fix". Include pulsantiera a parete per comandi luce.

Square ceiling shower head, 44x44 cm, with 2 water outlets: rain jet and central single jet. Spotlight for colourtherapy, mirror polished stainless steel. "Easy Fix" mounting system. Wall push-button panel for light controls included.

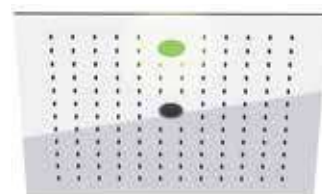

CR

PULSANTIERA CON INSTALLAZIONE A PARETE IN DOTAZIONE AL PRODOTTO:

WALL MOUNTING PUSH-BUTTON PANEL SUPPLIED WITH THE PRODUCT:

Gestione delle funzioni di cromoterapia:

- Prima pressione: ACCESO
- Pressioni successive: scelta manuale del colore
- Pressione prolungata (2 secondi): rotazione automatica dei colori
- 2 pressioni consecutive: SPENTO
- Sequenza colori LED RGB:
- Bianco - Rosso - Verde - Blu - Giallo - Fucsia - Azzurro

Colour therapy functions control:

- First button press: POWER ON
- Subsequent button presses: manual colour selection
- Long press (2 seconds): automatic colour rotation
- 2 consecutive button presses: POWER OFF
- RGB LED Colour sequence:
- White - Red - Green - Blue - Yellow - Fuchsia - Bright Blue



SOFFIONI A LED A SOFFITTO CON CORNICE

LED CEILING SHOWER HEADS WITH OUTER FRAME



IN DOTAZIONE AI MODELLI
SUPPLIED THE MODEL

Pulsantiera a parete per accensione luce bianca, selezione colori e cromoterapia automatica.
Wall push-button to turn, on, select the colors and change of the jet.

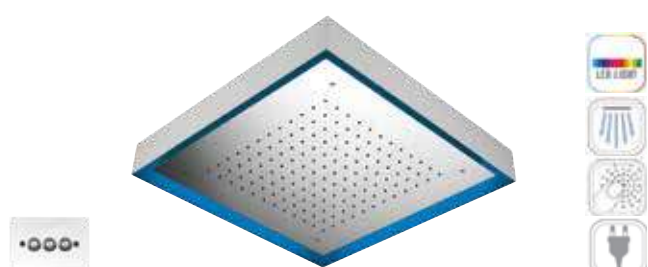

Soffione retroilluminato a soffitto in Acciaio INOX anticalcare 20x20 cm, con getto a pioggia. Luce LED a 7 colori con 40 sfumature, alimentazione dalla rete elettrica con trasformatore a basso voltaggio incluso (12V). Pulsantiera a parete inclusa.

Ceiling stainless steel backlighted antilimestone shower head 20x20 cm, with 1 rain jet. 7 colors light led with 40 shades. Powered by electricity with low voltage transformer included (12V). Wall push-button included.

357LS20	20x20 cm	CR
357LS37	37x37 cm	CR
357LS57	57x57 cm	CR

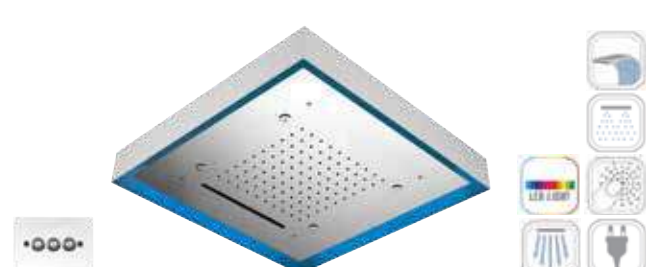

357LS57NC

Soffione retroilluminato a soffitto in Acciaio INOX anticalcare 57x57 cm, con 3 funzioni: getto a pioggia, nebulizzazione (4 uscite) ed 1 getto a cascata. Luce LED a 7 colori con 40 sfumature, alimentazione dalla rete elettrica con trasformatore a basso voltaggio incluso (12V). Pulsantiera a parete inclusa.

Ceiling stainless steel backlighted antilimestone shower head 57x57 cm, with 3 functions: 1 rain jet nebulization (4 outlets) and 1 waterfall jet. 7 colors light led with 40 shades. Powered by electricity with low voltage transformer included (12V). Wall push-button included.

		CR
--	--	----

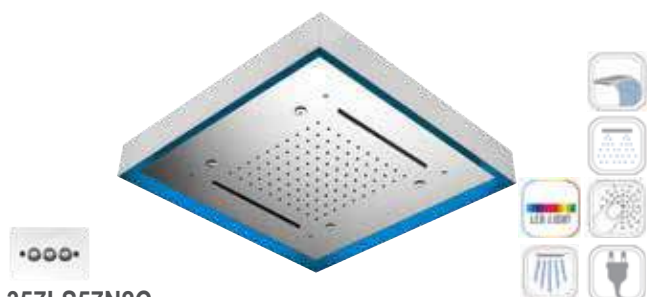

357LS57N2C

Soffione retroilluminato a soffitto in Acciaio INOX anticalcare 57x57 cm, con 3 funzioni: getto a pioggia, nebulizzazione (4 uscite) e 2 getti a cascata. Luce LED a 7 colori con 40 sfumature, alimentazione dalla rete elettrica con trasformatore a basso voltaggio incluso (12V). Pulsantiera a parete inclusa.

Ceiling stainless steel backlighted antilimestone shower head 57x57 cm, with 3 functions: 1 rain jet nebulization (4 outlets) and 2 waterfall jets. 7 colors light led with 40 shades. Powered by electricity with low voltage transformer included (12V). Wall push-button included.

		CR
--	--	----

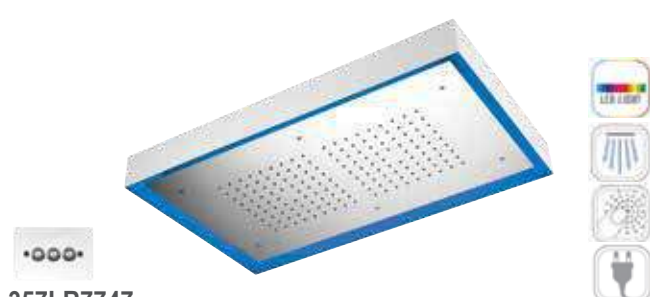

357LR7747

Soffione retroilluminato a soffitto in Acciaio INOX anticalcare 77x47 cm, con 2 postazioni pioggia. Luce LED a 7 colori con 40 sfumature, alimentazione dalla rete elettrica con trasformatore a basso voltaggio incluso (12V). Pulsantiera a parete inclusa.

Ceiling stainless steel backlighted antilimestone shower head 77x47 cm, with 2 workstations rain jet. 7 colors light led with 40 shades. Powered by electricity with low voltage transformer included (12V). Wall push-button included.

		CR
--	--	----

Disponibili, su richiesta, in finitura;
Available, on request, in finish;



Soffione retroilluminato a soffitto in Acciaio INOX anticalcare, getto pioggia. Luce LED a 7 colori con 40 sfumature, alimentazione dalla rete elettrica con trasformatore a basso voltaggio incluso (12V). Pulsantiera a parete inclusa.
Ceiling stainless steel backlit antilimesone shower head, with rain jet. 7 colors light led with 40 shades. Powered by electricity with low voltage transformer included (12V). Wall push-button included.

CR

357LM20 Ø 20 cm

CR

357LM37 Ø 37 cm

CR

357LM57 Ø 57 cm



357LM57N

Soffione retroilluminato a soffitto in Acciaio INOX anticalcare Ø57 cm, con 2 funzioni: getto pioggia e nebulizzazione (4 uscite). Luce LED a 7 colori con 40 sfumature, alimentazione dalla rete elettrica con trasformatore a basso voltaggio incluso (12V). Pulsantiera a parete inclusa.

Ceiling stainless steel backlit antilimesone shower head Ø57 cm, with 2 functions: rain jet and nebulization (4 outlets). 7 colors light led with 40 shades. Powered by electricity with low voltage transformer included (12V). Wall push-button included.

CR

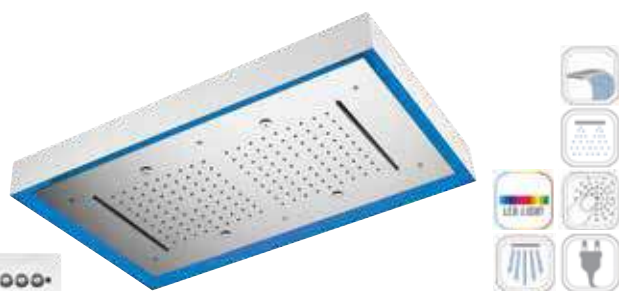

357LR7747N2C

Soffione a soffitto in Acciaio INOX 77x47 cm, con 3 funzioni: 2 getti cascata, nebulizzazione (4 uscite) e 2 postazioni pioggia. Luce LED a 7 colori con 40 sfumature, alimentazione dalla rete elettrica con trasformatore a basso voltaggio incluso (12V). Pulsantiera a parete inclusa.

Ceiling stainless steel backlit antilimesone shower head 77x47 cm, with 3 functions: 2 workstations rain jet, nebulization (4 outlets) and 2 waterfall jets. 7 colors light led with 40 shades. Powered by electricity with low voltage transformer included (12V). Wall push-button included.

CR





BORDO VASCA
DECK BATH MIXERS

DOCLETTE
HANDSHOWERS

SALISCENDI
SLIDING RAILS

PANNELLI DOCCIA
SHOWER PANELS

BOCCHE
SPOUTS

SOFFIONI
SHOWER HEADS

CROMOTERAPIA
COLORTHERAPY

KIT WELLNESS
WELLNESS KIT

COLONNE DOCCIA
SHOWER COLUMNS

TERMOSTATICI
THERMOSTATICS

A PULSANTE
PUSH-BUTTON

BOX INCASSO
BUILT-IN BOX

SOFFIONI A SOFFITTO A LED LED CEILING SHOWER HEADS

Disponibili, su richiesta, in finitura;
Available, on request, in finish;



IN DOTAZIONE AI MODELLI
SUPPLIED THE MODEL

Pulsantiera a parete per accensione luce bianca, selezione colori e cromoterapia automatica.
Wall push-button to turn, on, select the colors and change of the jet.



IN DOTAZIONE AI MODELLI CON CODICE "W"
SUPPLIED THE MODEL WITH "W" CODE

Pulsantiera wireless per accensione luce bianca, selezione colori e cromoterapia automatica.
Wireless push-button to turn, on, select the colors and change of the jet.

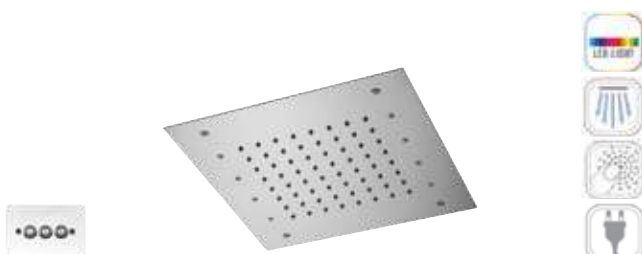

Soffione a soffitto in Acciaio INOX lucidato a specchio 30x30 cm, getto a pioggia anticalcare. Luce LED a 7 colori con 40 sfumature, alimentazione dalla rete elettrica con trasformatore a basso voltaggio incluso (12V). Pulsantiera a parete inclusa.

Ceiling stainless steel mirror polished shower head 30x30 cm, with antilimestone rain jet. 7 colors light led with 40 shades. Powered by electricity with low voltage transformer included (12V). Wall push-button included.

CR

357RS30

357RS30W

con pulsantiera
with remote control



CR

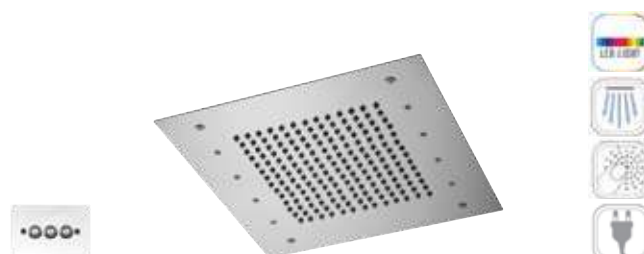

Soffione a soffitto in Acciaio INOX lucidato a specchio 43x43 cm, getto a pioggia anticalcare. Luce LED a 7 colori con 40 sfumature, alimentazione dalla rete elettrica con trasformatore a basso voltaggio incluso (12V). Pulsantiera a parete inclusa.

Ceiling stainless steel mirror polished shower head 43x43 cm, with antilimestone rain jet. 7 colors light led with 40 shades. Powered by electricity with low voltage transformer included (12V). Wall push-button included.

CR

357RS43

357RS43W

con pulsantiera
with remote control



CR



Soffione a soffitto in Acciaio INOX lucidato a specchio 50x50 cm, getto a pioggia anticalcare. Luce LED a 7 colori con 40 sfumature, alimentazione dalla rete elettrica con trasformatore a basso voltaggio incluso (12V). Pulsantiera a parete inclusa.

Ceiling stainless steel mirror polished shower head 50x50 cm, with antilimestone rain jet. 7 colors light led with 40 shades. Powered by electricity with low voltage transformer included (12V). Wall push-button included.

CR

357RS50

357RS50W

con pulsantiera
with remote control



CR



Soffione a soffitto in Acciaio INOX lucidato a specchio 43x43 cm, con 3 funzioni: getto a pioggia anticalcare, nebulizzazione (4 uscite) e getto a cascata. Luce LED a 7 colori con 40 sfumature, alimentazione dalla rete elettrica con trasformatore a basso voltaggio incluso (12V). Pulsantiera a parete inclusa.

Ceiling stainless steel mirror polished shower head 43x43 cm, with 3 functions: antilimestone rain jet, nebulization (4 outlets) and 1 waterfall jet. 7 colors light led with 40 shades. Powered by electricity with low voltage transformer included (12V). Wall push-button included.

CR

357RS43NC

357RS43NCW

con pulsantiera
with remote control



CR

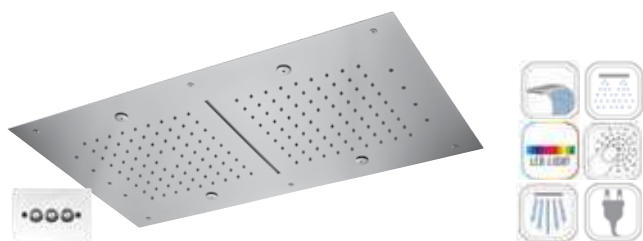

Soffione a soffitto in Acciaio INOX lucidato a specchio 70x40 cm, con 3 funzioni: 2 postazioni getto a pioggia anticalcare, nebulizzazione (4 uscite) ed 1 getto a cascata centrale. Luce LED a 7 colori con 40 sfumature, alimentazione dalla rete elettrica con trasformatore a basso voltaggio incluso (12V). Pulsantiera a parete inclusa.

Ceiling stainless steel mirror polished shower head 70x40 cm, with 3 functions: 2 antilime rain jet workstations, nebulization (4 outlets) and 1 central waterfall jet. 7 colors light led with 40 shades. Powered by electricity with low voltage transformer included (12V). Wall push-button included.

CR

357RR7040NC**357RR7040NCW**con pulsantiera
with remote control

CR



Soffione a soffitto in Acciaio INOX lucidato a specchio 70x40 cm, con 3 funzioni: getto pioggia anticalcare, nebulizzazione (4 uscite) e 2 getti a cascata laterali. Luce LED a 7 colori con 40 sfumature, alimentazione dalla rete elettrica con trasformatore a basso voltaggio incluso (12V). Pulsantiera a parete inclusa.

Ceiling stainless steel mirror polished shower head 70x40 cm, with 3 functions: antilime rain jet, nebulization (4 outlets) and 2 lateral waterfall jet. 7 colors light led with 40 shades. Powered by electricity with low voltage transformer included (12V). Wall push-button included.

CR

357RR7040N2C**357RR7040N2CW**con pulsantiera
with remote control

CR

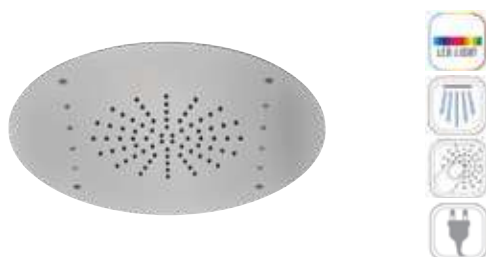

Soffione a soffitto in Acciaio INOX lucidato a specchio Ø42 cm, con getto a pioggia anticalcare. Luce LED a 7 colori con 40 sfumature, alimentazione dalla rete elettrica con trasformatore a basso voltaggio incluso (12V). Pulsantiera a parete inclusa.

Ceiling stainless steel mirror polished shower head Ø42 cm, with antilime rain jet. 7 colors light led with 40 shades. Powered by electricity with low voltage transformer included (12V). Wall push-button included.

CR

357RM42**357RM42W**con pulsantiera
with remote control

CR

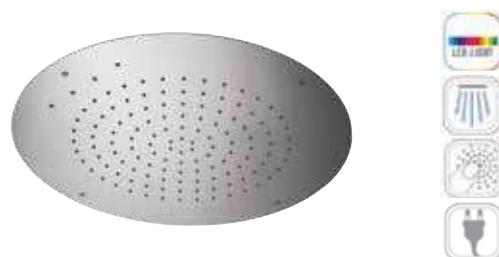

Soffione a soffitto in Acciaio INOX lucidato a specchio Ø55 cm, con getto a pioggia anticalcare. Luce LED a 7 colori con 40 sfumature, alimentazione dalla rete elettrica con trasformatore a basso voltaggio incluso (12V). Pulsantiera a parete inclusa.

Ceiling stainless steel mirror polished shower head Ø55 cm, with antilime rain jet. 7 colors light led with 40 shades. Powered by electricity with low voltage transformer included (12V). Wall push-button included.

CR

357RM55**357RM55W**con pulsantiera
with remote control

CR

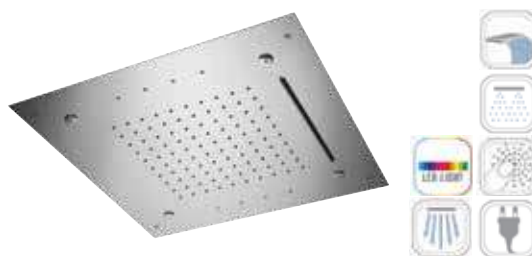

Soffione a soffitto in Acciaio INOX lucidato a specchio 50x50 cm, con 3 funzioni: getto a pioggia anticalcare, nebulizzazione (4 uscite) e getto a cascata. Luce LED a 7 colori con 40 sfumature, alimentazione dalla rete elettrica con trasformatore a basso voltaggio incluso (12V). Pulsantiera a parete inclusa.

Ceiling stainless steel mirror polished shower head 50x50 cm, with 3 functions: antilime rain jet, nebulization (4 outlets) and 1 waterfall jet. 7 colors light led with 40 shades. Powered by electricity with low voltage transformer included (12V). Wall push-button included.

CR

357RS50NC**357RS50NCW**con pulsantiera
with remote control

CR



Soffione a soffitto in Acciaio INOX lucidato a specchio Ø55 cm, con 2 funzioni: getto a pioggia anticalcare e nebulizzato (4 uscite). Luce LED a 7 colori con 40 sfumature, alimentazione dalla rete elettrica con trasformatore a basso voltaggio incluso (12V). Pulsantiera a parete inclusa.

Ceiling stainless steel mirror polished shower head Ø55 cm, with 2 functions: antilime rain jet and nebulization (4 outlets). 7 colors light led with 40 shades. Powered by electricity with low voltage transformer included (12V). Wall push-button included.

CR

357RM55N**357RM55NW**con pulsantiera
with remote control

CR

SOFFIONI A PARETE A LED WALL LED SHOWER HEADS

Disponibili, su richiesta, in finitura;
Available, on request, in finish;



IN DOTAZIONE AI MODELLI
SUPPLIED THE MODEL

Pulsantiera a parete per accensione luce bianca, selezione colori e cromoterapia automatica.
Wall push-button to turn, on, select the colors and change of the jet.



IN DOTAZIONE AI MODELLI CON CODICE "W"
SUPPLIED THE MODEL WITH "W" CODE

Pulsantiera wireless per accensione luce bianca, selezione colori e cromoterapia automatica.
Wireless push-button to turn, on, select the colors and change of the jet.



Soffione a parete in Acciaio INOX lucidato a specchio 50x26x6,4 cm, con 1 postazione pioggia. Luce LED a 7 colori con 40 sfumature, alimentazione dalla rete elettrica con trasformatore a basso voltaggio incluso (12V). Con pulsantiera a parete inclusa.

Wall stainless steel mirror polished shower head 50x26x6,4 cm, 1 rain jet workstation. 7 colors light led with 40 shades. Powered by electricity with low voltage transformer included (12V). With wall push-button included.

CR

350RSS

350RSSW

con pulsantiera
with remote control



CR



Soffione a parete in Acciaio INOX lucidato a specchio 50x26x6,4 cm, con 1 postazione pioggia ed 1 getto a cascata. Luce LED a 7 colori con 40 sfumature, alimentazione dalla rete elettrica con trasformatore a basso voltaggio incluso (12V). Con pulsantiera a parete inclusa.

Wall stainless steel mirror polished shower head 50x26x6,4 cm, 1 rain jet workstation and waterfall jet. 7 colors light led with 40 shades. Powered by electricity with low voltage transformer included (12V). With wall push-button included.

CR

350RSSCA

350RSSCAW

con pulsantiera
with remote control



CR



350RSSCA

SOFFIONI - SHOWER HEADS

SOFFIONI SHOWER HEADS



Una selezione di soffioni doccia diversi per forme, dimensioni, funzioni e materiali che consentono di personalizzare il proprio interno doccia con la soluzione più adatta in termini di estetica e di performance.

A selection of shower heads with different shapes, sizes, functions and materials to customize your shower interior with the most suitable solution in terms of aesthetics and performance.



BORDO VASCA
DECK BATH MIXERS

DOCCE
HANDSHOWERS

SALISCENDI
SLIDING RAILS

PANNELLI DOCCIA
SHOWER PANELS

BOCCHE
SPOUTS

SOFFIONI
SHOWER HEADS

CROMOTERAPIA
COLOR THERAPY

KIT WELLNESS
WELLNESS KIT

COLONNE DOCCIA
SHOWER COLUMNS

TERMOSTATICI
THERMOSTATICS

A PULSANTE
PUSH-BUTTON

BOX INCASSO
BUILT-IN BOX

SOFFIONI A SOFFITTO CEILING SHOWER HEADS

Disponibili, su richiesta, in finitura;
Available, on request, in finish;



SOFFIONI A SOFFITTO CON TELAIO - CEILING SHOWER HEADS WITH FIXING SET



357SFS30

Soffione a soffitto in Acciaio INOX lucidato a specchio, getti anticalcare, 30x30 cm con getto a pioggia.
Ceiling stainless steel mirror polished shower head, antilime scale jets, 30x30 cm, with rain.

CR

BO - NO

BG

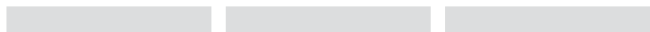

357SFS43

Soffione a soffitto in Acciaio INOX lucidato a specchio, getti anticalcare, 43x43 cm con getto a pioggia.
Ceiling stainless steel mirror polished shower head, antilime scale jets, 43x43 cm, with rain jet.

CR

BO - NO

BG

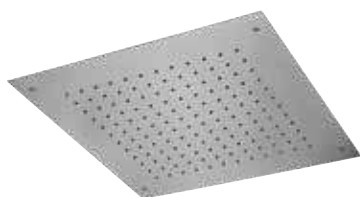

357SFS50

Soffione a soffitto in Acciaio INOX lucidato a specchio, getti anticalcare, 50x50 cm con getto a pioggia.
Ceiling stainless steel mirror polished shower head, antilime scale jets, 50x50 cm, with rain jet.

CR

BO - NO

BG

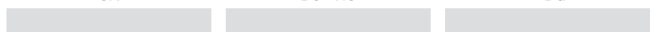

357SFS43C

Soffione a soffitto in Acciaio INOX lucidato a specchio, getti anticalcare, 43x43 cm, a 2 funzioni: pioggia e cascata.
Ceiling stainless steel mirror polished shower head, antilime scale jets, 43x43 cm, 2 functions: rain and waterfall.

CR

BO - NO

BG

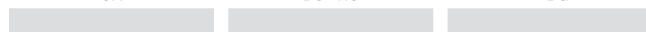

357SFS50C

Soffione a soffitto in Acciaio INOX lucidato a specchio, getti anticalcare, 50x50 cm, a 2 funzioni: pioggia e cascata.
Ceiling stainless steel mirror polished shower head, antilime scale jets, 50x50 cm, 2 functions: rain and waterfall.

CR

BO - NO

BG

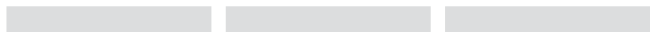

357SFS43NC

Soffione a soffitto in Acciaio INOX lucidato a specchio, getti anticalcare, 43x43 cm, a 3 funzioni: pioggia, nebulizzazione (4 uscite) ed 1 getto a cascata.
Ceiling stainless steel mirror polished shower head, antilime scale jets, 43x43 cm, 3 functions: rain jet, nebulization (4 outlet) and waterfall.

CR

BO - NO

BG

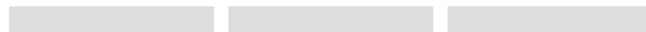

**357SFS50NC**

Soffione a soffitto in Acciaio INOX lucidato a specchio, getti anticalcare, 50x50 cm, a 3 funzioni: pioggia, nebulizzazione (4 uscite) ed 1 getto a cascata.

Ceiling stainless steel mirror polished shower head, antilimestone jets, 50x50 cm, 3 functions: rain, nebulization (4 outlet) and waterfall.

CR BO - NO BG

**357SFR7040**

Soffione a soffitto in Acciaio INOX, getti anticalcare, 70x40 cm, 2 postazioni pioggia.

Ceiling stainless steel mirror polished shower head, antilimestone jets, 70x40 cm, with 2 rain jet workstations.

CR BO - NO BG

**357SFR7040C**

Soffione a soffitto in Acciaio INOX, getti anticalcare, 70x40 cm, a 2 funzioni: 2 postazioni pioggia, ed un getto a cascata centrale.

Ceiling stainless steel shower head, antilimestone jets, 70x40 cm, with 2 functions: 2 rain jet workstations and a central waterfall jet.

CR BO - NO BG

**357SFR7040NC**

Soffione a soffitto in Acciaio INOX lucidato a specchio, getti anticalcare, 70x40 cm, 3 funzioni: 2 postazioni pioggia, nebulizzazione (4 uscite), ed un getto a cascata centrale.

Ceiling stainless steel mirror polished shower head, antilimestone jets, 70x40 cm, 3 functions: 2 rain jet workstation, nebulization (4 outlets) and a central waterfall jet.

CR BO - NO BG

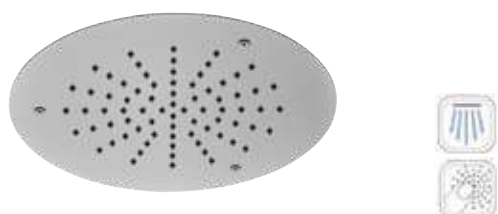

Soffione a soffitto in Acciaio INOX lucidato a specchio, con getto anticalcare a pioggia.

Ceiling stainless steel mirror polished shower head, with antilimestone rain jet.

CR BO - NO BG

357SFM30 Ø 30 cm

CR BO - NO BG

357SFM40 Ø 40 cm

CR BO - NO BG

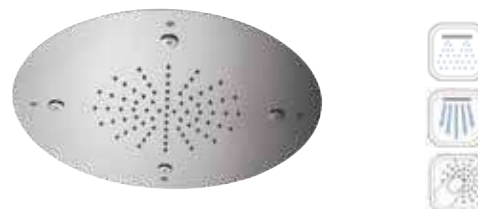
357SFM55 Ø 55 cm**357SFM42N**

Soffione a soffitto in Acciaio INOX lucidato a specchio Ø42 cm, con getti anticalcare, a 2 funzioni: pioggia e nebulizzazione (4 uscite).

Ceiling stainless steel mirror polished shower head Ø42 cm, antilimestone jets, with 2 functions: rain and nebulization (4 outlets).

CR BO - NO BG

**357SFM55N**

Soffione a soffitto in Acciaio INOX lucidato a specchio Ø55 cm, getti anticalcare, a 2 funzioni: pioggia e nebulizzazione (6 uscite).

Ceiling stainless steel mirror polished shower head Ø55 cm, antilimestone jets, with 2 functions: rain and nebulization (6 outlets).

CR BO - NO BG

SOFFIONI A SOFFITTO "EASY FIX" - CEILING SHOWER HEADS "EASY FIX"

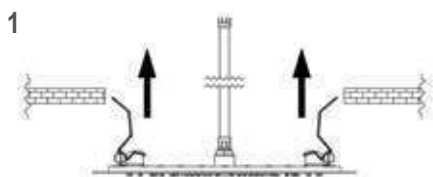

1
Per questa tipologia di soffione e con questo specifico sistema di fissaggio sono previste quattro molle per ogni soffione.

Nell'immagine 1 si evidenzia il primo movimento necessario:

caricare due molle vicine tra loro mettendole quasi in posizione verticale rispetto al soffione ed inserirle all'interno del foro precedentemente preparato.

Rilasciare le stesse delicatamente.

For this specific shower-head with this specific mounting system, four springs are installed on each head.

In picture 1, you shall see the first needed movement to activate them:

Spring-load two springs next to each other placing them almost vertically and insert them in the hole in the ceiling;

Release them gently;

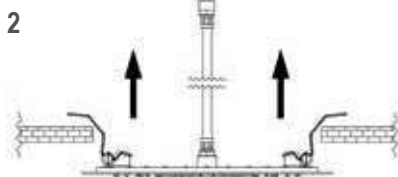

2
Mantenendo il soffione leggermente inclinato procedere caricando ed inserendo le rimanenti due molle come da immagine 2.

While keeping the shower head slightly inclined, proceed by spring-loading and inserting the two other springs as shown in picture 2.



3
A questo punto rilasciare delicatamente le molle alla loro naturale tensione e, trattenendo esternamente il soffione, accompagnare lo stesso verso il totale appoggio al soffitto come da immagine 3.

Now release the springs back to their natural tension and, while holding the head from outside, guide it to its final position as shown in picture 3.

Soffione rettangolare a soffitto 60x30 cm con due uscite acqua: getto a pioggia e getto singolo laterale. Acciaio INOX lucidato a specchio. Sistema di montaggio "Easy Fix".

Rectangular ceiling shower head, 60x30 cm, with 2 water outlets: rain jet and lateral single jet. Mirror polished stainless steel. "Easy Fix" mounting system.



357EFR6030

Soffione rettangolare a soffitto 60x30 cm con getto a pioggia. Acciaio INOX lucidato a specchio. Sistema di montaggio "Easy Fix".

Rectangular ceiling shower head, 60x30 cm, with rain jet. Mirror polished stainless steel. "Easy Fix" mounting system.

CR BO - NO BG

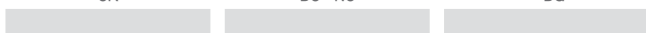

357EFR6030G

Soffione rettangolare a soffitto 60x30 cm con due uscite acqua: getto a pioggia e getto singolo laterale. Acciaio INOX lucidato a specchio. Sistema di montaggio "Easy Fix".

Rectangular ceiling shower head, 60x30 cm, with 2 water outlets: rain jet and lateral single jet. Mirror polished stainless steel. "Easy Fix" mounting system.

CR BO - NO BG

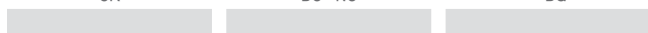

357EFM34

Soffione doccia EASY FIX in acciaio INOX lucidato a specchio Ø34 cm. Con getti anticalcare.

EASY FIX stainless steel mirror polished shower head Ø34 cm. With antilimestone jets.

CR BO - NO BG

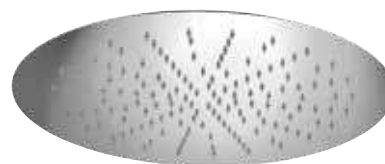

357EFM44

Soffione doccia EASY FIX in acciaio INOX lucidato a specchio Ø44 cm. Con getti anticalcare.

EASY FIX stainless steel mirror polished shower head Ø44 cm. With antilimestone jets.

CR BO - NO BG



357EFS34

Soffione doccia EASY FIX in acciaio INOX lucidato a specchio 34x34 cm. Con getti anticalcare.

EASY FIX stainless steel mirror polished shower head 34x34 cm. With antilimestone jets.

CR BO - NO BG

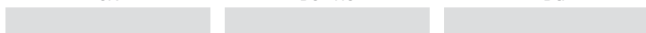

357EFS44

Soffione doccia EASY FIX in acciaio INOX lucidato a specchio 44x44 cm. Con getti anticalcare.

EASY FIX stainless steel mirror polished shower head 44x44 cm. With antilimestone jets.

CR BO - NO BG

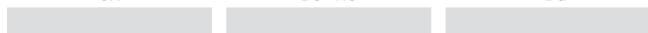

2 VIE
WAYS**357EFM34G**

Soffione tondo a soffitto Ø34 cm con due uscite acqua: getto a pioggia e getto singolo centrale. Ispezionabile. Acciaio INOX lucidato a specchio. Sistema di montaggio "Easy Fix".

Round ceiling shower head, Ø34 cm, with 2 water outlets: rain jet and central single jet. Mirror polished stainless steel. "Easy Fix" mounting system.



CR

BO - NO

BG

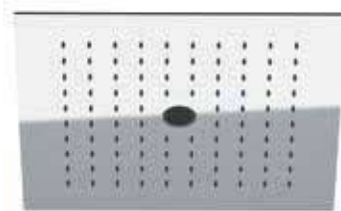
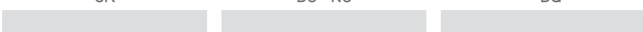
**357EFS34G**

Soffione quadrato a soffitto 34x34 cm con due uscite acqua: getto a pioggia e getto singolo centrale. Ispezionabile. Acciaio INOX lucidato a specchio. Sistema di montaggio "Easy Fix".

Square ceiling shower head, 34x34 cm, with 2 water outlets: rain jet and central single jet. Mirror polished stainless steel. "Easy Fix" mounting system.



CR

BO - NO

BG

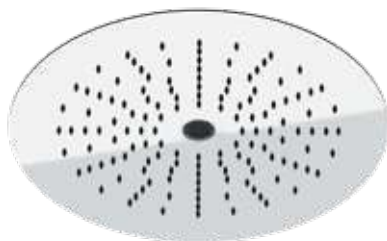
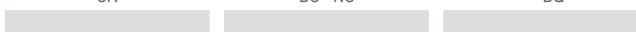
**357EFM44G**

Soffione tondo a soffitto Ø44 cm con due uscite acqua: getto a pioggia e getto singolo centrale. Ispezionabile. Acciaio INOX lucidato a specchio. Sistema di montaggio "Easy Fix".

Round ceiling shower head, Ø44 cm, with 2 water outlets: rain jet and central single jet. Mirror polished stainless steel. "Easy Fix" mounting system.



CR

BO - NO

BG

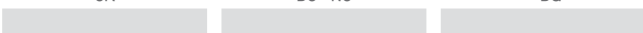
**357EFS44G**

Soffione quadrato a soffitto 44x44 cm con due uscite acqua: getto a pioggia e getto singolo centrale. Ispezionabile. Acciaio INOX lucidato a specchio. Sistema di montaggio "Easy Fix".

Square ceiling shower head, 44x44 cm, with 2 water outlets: rain jet and central single jet. Mirror polished stainless steel. "Easy Fix" mounting system.



CR

BO - NO

BG

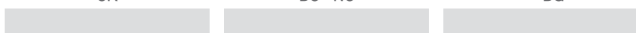

BLACK VERSION



Soffione doccia EASY FIX in acciaio INOX Ø34 cm. Con getti anticalcare. EASY FIX stainless steel shower head Ø34 cm. With antilimestone jets.

NO

357EFM34NO Ø 34 cm

NO

357EFM44NO Ø 44 cm

Soffione doccia EASY FIX in acciaio INOX 44x44 cm. Con getti anticalcare. EASY FIX stainless steel shower head 44x44 cm. With antilimestone jets.

NO

357EFS34NO 34x34 cm

NO

357EFS44NO 44x44 cm

SOFFIONI A PARETE WALL SHOWER HEADS

Disponibili, su richiesta, in finitura;
Available, on request, in finish;



SOFFIONI A PARETE INCLINATI - INCLINED WALL SHOWER HEADS



350H3M22X

Soffione doccia inclinato, a parete, con braccio, in acciaio inox lucidato a specchio, Ø 22 cm.
Inclined shower head, wall-mounted, with arm, mirror polished stainless steel, Ø 22 cm.

CR

BO - NO

BG

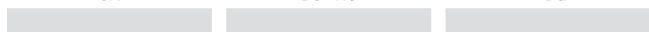

350H3M32X

Soffione doccia inclinato, a parete, con braccio, in acciaio inox lucidato a specchio, Ø 32 cm.
Inclined shower head, wall-mounted, with arm, mirror polished stainless steel, Ø 32 cm.

CR

BO - NO

BG

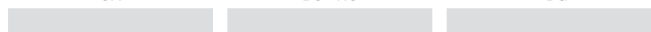

LINEA MINIMALE IN ACCIAIO INOX - STAINLESS STEEL MINIMAL LINE



350UFMX

Soffione doccia anticalcare ultrapiatto 50x20 cm, a parete in acciaio INOX lucidato a specchio.
Ultraslim antilimestone stainless steel mirror polished wall shower head 50x20 cm.

CR

BO - NO

BG

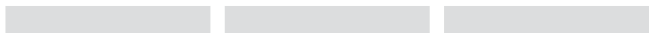

350UFMCAX

Soffione doccia anticalcare ultrapiatto 50x20 cm, a parete in acciaio INOX lucidato a specchio, 2 funzioni: pioggia e cascata.
Ultraslim antilimestone stainless steel mirror polished wall shower head, 2 functions: rain and waterfall, 50x20 cm.

CR

BO - NO

BG

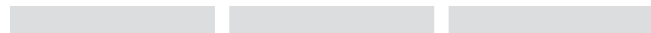

350MMX

Soffione doccia anticalcare 50x20 cm, a parete in acciaio INOX lucidato a specchio.
Stainless antilimestone steel mirror polished wall shower head 50x20 cm.

CR

BO - NO

BG

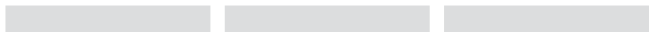

350MMCAX

Soffione doccia anticalcare 50x20 cm, a parete in acciaio INOX lucidato a specchio, 2 funzioni: a pioggia e cascata.
Stainless steel antilimestone mirror polished wall shower head, 2 functions: rain and waterfall, 50x20 cm.

CR

BO - NO

BG

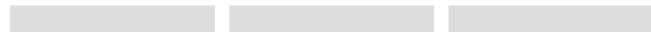

LINEA QUADRATA IN ACCIAIO INOX - STAINLESS STEEL SQUARED LINE

**350UFX**

Soffione doccia anticalcare ultrapiatto 50x22 cm, a parete in acciaio INOX lucidato a specchio.
Ultraslim antilimestone stainless steel mirror polished wall shower head 50x22 cm.

CR BO - NO BG

**350UFCAX**

Soffione doccia anticalcare ultrapiatto 50x22 cm, a parete in acciaio INOX lucidato a specchio, 2 funzioni: getto a pioggia e cascata.
Ultraslim antilimestone stainless steel mirror polished wall shower head, 2 functions: rain and waterfall, 50x22 cm.

CR BO - NO BG

**350SSX**

Soffione doccia anticalcare a parete 50x20 cm, in acciaio INOX lucidato a specchio.
Stainless steel mirror polished wall shower head antilimestone 50x20 cm.

CR BO - NO BG

**350SSCAX**

Soffione doccia anticalcare a parete 50x20 cm, in acciaio INOX lucidato a specchio, 2 funzioni: getto a pioggia e cascata.
Stainless steel mirror polished wall shower head antilimestone, 2 functions: rain and waterfall, 50x20 cm.

CR BO - NO BG

LINEA QUADRATA CON ANGOLI ARROTONDATI IN ACCIAIO INOX
STAINLESS STEEL SQUARED LINE WITH ROUND CORNERS**350UFDX**

Soffione doccia ultrapiatto 5mm, 50x22 cm, a parete in acciaio INOX lucidato a specchio, anticalcare.
5 mm ultraslim stainless steel mirror polished wall shower head, 50x22 cm, antilimestone.

CR BO - NO BG

**350UFDCA**

Soffione doccia anticalcare, ultrapiatto 5mm, 50x22 cm, a parete in acciaio INOX lucidato a specchio, a 2 funzioni: pioggia e cascata.
Antilimestone, 5 mm ultraslim stainless steel mirror polished wall shower head, 2 functions: rain jet and waterfall, 50x22 cm.

CR BO - NO BG

SOFFIONI A PARETE MINIMALI - MINIMAL WALL SHOWER HEADS

**350XN**

Soffione doccia Ø 15 cm, lunghezza 30 cm, a parete in acciaio INOX lucidato a specchio.
Stainless steel mirror polished wall shower head Ø15 cm, length 30 cm.

CR BO - NO BG

**350XS**

Soffione doccia 15x15 cm, lunghezza 25 cm, a parete in acciaio INOX lucidato a specchio.
Stainless steel mirror polished wall shower head 15x15 cm, length 25 cm, .

CR BO - NO BG

BLACK VERSION



350MMNOX

Soffione doccia anticalcare 50x20 cm, a parete in acciaio INOX.
Stainless antilimestone steel wall shower head 50x20 cm.

NO



350MMCANOX

Soffione doccia anticalcare 50x20 cm, a parete in acciaio INOX, 2 funzioni: a pioggia e cascata.
Stainless steel antilimestone wall shower head, 2 functions: rain and waterfall, 50x20 cm.

NO



350SSNOX

Soffione doccia anticalcare a parete 50x20 cm, in acciaio INOX.
Stainless steel wall shower head antilimestone 50x20 cm.

NO



350SSCANOX

Soffione doccia anticalcare a parete 50x20 cm, in acciaio INOX, 2 funzioni: getto a pioggia e cascata.
Stainless steel wall shower head antilimestone, 2 functions: rain and waterfall, 50x20 cm.

NO



350UFMNOX

Soffione doccia anticalcare ultrapiatto 50x20 cm, a parete in acciaio INOX.
Ultraslim antilimestone stainless steel wall shower head 50x20 cm.

NO



350UFMCANOX

Soffione doccia anticalcare ultrapiatto 50x20 cm, a parete in acciaio INOX, 2 funzioni: pioggia e cascata.
Ultraslim antilimestone stainless steel wall shower head, 2 functions: rain and waterfall, 50x20 cm.

NO



350UFNOX

Soffione doccia anticalcare ultrapiatto 50x22 cm, a parete in acciaio INOX.
Ultraslim antilimestone stainless steel wall shower head 50x22 cm.

NO



350UFCANOX

Soffione doccia anticalcare ultrapiatto 50x22 cm, a parete in acciaio INOX, 2 funzioni: getto a pioggia e cascata.
Ultraslim antilimestone stainless steel wall shower head, 2 functions: rain and waterfall, 50x22 cm.

NO



350MMCANOX

WELLNESS

BORDO VASCA
DECK BATH MIXERS

DOCCHETTE
HANDSHOWERS

SALISCENDI
SLIDING RAILS

PANNELLI DOCCIA
SHOWER PANELS

BOCCHE
SPOUTS

SOFFIONI
SHOWER HEADS

CROMOTERAPIA
COLORTHERAPY

KIT WELLNESS
WELLNESS KIT

COLONNE DOCCIA
SHOWER COLUMNS

TERMOSTATICI
THERMOSTATICS

A PULSANTE
PUSH-BUTTON

BOX INCASSO
BUILT-IN BOX

SOFFIONI CON BRACCIO DOCCIA SHOWER ARM SHOWER HEADS

Disponibili, su richiesta, in finitura;
Available, on request, in finish;



LINEA MINIMALE IN ACCIAIO INOX STAINLESS STEEL MINIMAL LINE



Soffione doccia anticalcare ultrapiatto in acciaio INOX lucidato a specchio.
Ultraslim antilimestone stainless steel mirror polished shower head.

357UFM20X	Ø20 cm	CR	BO - NO
357UFM25X	Ø25 cm	CR	BO - NO
357UFM30X	Ø30 cm	CR	BO - NO
357UFM40X	Ø40 cm	CR	BO - NO

LINEA QUADRATA CON ANGOLI ARROTONDATI IN ACCIAIO INOX STAINLESS STEEL SQUARED LINE WITH ROUND CORNERS



Soffione doccia quadrato con angoli arrotondati ultrapiatto in Acciaio Inox lucidato a specchio, con getti in silicone anticalcare.
Squared with rounded corners ultraslim stainless steel mirror polished shower head, with antilimestone silicon jets.

357UFD20X	20x20 cm	CR	BO - NO
357UFD25X	25x25 cm	CR	BO - NO
357UFD30X	30x30 cm	CR	BO - NO
357UFD40X	40x40 cm	CR	BO - NO

LINEA QUADRATA IN ACCIAIO INOX - STAINLESS STEEL SQUARED LINE



Soffione doccia anticalcare ultrapiatto in acciaio INOX lucidato a specchio.
Ultraslim antilimestone stainless steel mirror polished shower head.

357UFS20X	20x20 cm	CR	BO - NO
357UFS25X	25x25 cm	CR	BO - NO
357UFS30X	30x30 cm	CR	BO - NO
357UFS40X	40x40 cm	CR	BO - NO



357UFRX
Soffione doccia anticalcare ultrapiatto 33x22 cm in acciaio INOX lucidato a specchio.
Ultraslim antilimestone stainless steel mirror polished shower head 33x22 cm.

		CR	
--	--	----	--

BLACK VERSION



Soffione doccia anticalcare ultrapiatto in acciaio INOX.
Ultraslim antilimestone stainless steel shower head.

CR

357UFM20NOX	Ø20 cm
--------------------	--------

CR

357UFM25NOX	Ø25 cm
--------------------	--------

CR

357UFM30NOX	Ø30 cm
--------------------	--------

CR

357UFM40NOX	Ø40 cm
--------------------	--------



Soffione doccia anticalcare ultrapiatto in acciaio INOX.
Ultraslim antilimestone stainless steel shower head.

CR

357UFS20NOX	20x20 cm
--------------------	----------

CR

357UFS25NOX	25x25 cm
--------------------	----------

CR

357UFS30NOX	30x30 cm
--------------------	----------

CR

357UFS40NOX	40x40 cm
--------------------	----------



357UFS20NOX

TUTTO IN OTTONE - ALL IN BRASS



359SSX

Soffione SQ, tutto in ottone, getti in silicone soffice anticalcare, cm 20x20.

Shower head SQ, all in brass, soft silicon jets, antilimestone, cm 20x20.

CR

FIN 1

FIN 2

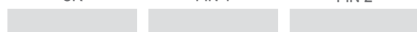

359WX

Soffione a pioggia rettangolare, a snodo, 24x14 cm in ottone, getti in silicone anticalcare.

Rectangular shower head with ball-joint, all in brass, 24x14 cm, silicon antilimestone jets.

CR

FIN 1

FIN 2

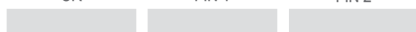

359SSLX

Soffione a pioggia quadrato piatto, a snodo, 30x30, cm in ottone, getti in silicone anticalcare.

Squared shower head, all in brass 30x30 cm, soft silicon antilimestone jets, with ball-joint.

CR

FIN 1

FIN 2

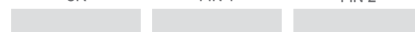

359SSXLX

Soffione a pioggia quadrato piatto, a snodo, 35x35 cm in ottone, getti in silicone anticalcare.

Square shower head, in brass, 35x35 cm, soft silicon antilimestone jets, with ball-joint.

CR

FIN 1

FIN 2

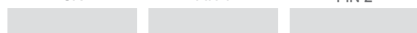

359MM20X

Soffione doccia minimale piatto in ottone, getti in silicone morbido, anticalcare, Ø 20 cm.

Minimal flat brass antilimestone shower head, soft silicon jets, Ø 20 cm.

CR

FIN 1

FIN 2

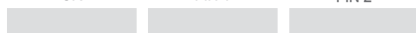

359MM30X

Soffione doccia minimale piatto in ottone, getti in silicone morbido, anticalcare, Ø 30cm.

Minimal flat brass antilimestone shower head, soft silicon jets, Ø 30 cm.

CR

FIN 1

FIN 2

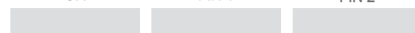

359MMXLX

Soffione a pioggia piatto, in ottone, a snodo Ø 35 cm cromato, getti in silicone anticalcare.

Minimal shower-head, in Brass, with ball-joint, Ø 35 cm, silicon antilimestone jets.

CR

FIN 1

FIN 2



359B20X

Soffione a "Pioggia" Ø20 cm, tutto in ottone, funzione raccoglimento acqua per situazioni di bassa pressione.

Shower head "Rain", Ø20 cm, all in brass, for low pressure situations.

CR

FIN 1

FIN 2

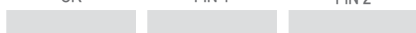

359BEX

Soffione a pioggia 30 getti "Bell" tutto in ottone, a snodo.

Shower-head 30 jets "Bell" all in brass, with ball-joint.

CR

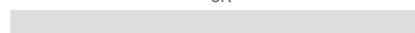

SOFFIONI IN ABS - ABS SHOWER HEADS

**354QIX**

Soffione doccia quadrato con angoli arrotondati in ABS cromato, ultrapiatto, cm 20x20, in ABS cromato con getti in silicone anticalcare.

Chrome plated ABS shower head, squared with rounded corners, ultrathin cm 20x20 with silicon antilimestone jets.

CR

**354EC20X**

Soffione a pioggia minimale, in ABS cromato, Ø 20 cm, con getti in silicone anticalcare.

C.p. ABS shower head, rain jet, Ø 20 cm, with antilimestone silicon jets.

CR

**356AD20X**

Soffione a pioggia squadrato con angoli arrotondati, in ABS cromato, 20x20 cm, con getti in silicone anticalcare.

C.p. ABS squared with rounded corners shower head, rain jet, 20x20 cm, with antilimestone silicon jets.

CR



Soffione doccia quadrato, in ABS lusso, cromato, con getti in silicone anticalcare.

Chrome plated square deluxe ABS shower head, with silicon antilimestone jets.

CR



Soffione doccia minimale in ABS lusso, cromato, con getti in silicone autopulenti e anticalcare.

Chrome plated minimal deluxe ABS shower head, with silicon antilimestone jets.

CR

356SD20X 20x20 cm**356MD20X** Ø20 cm**356SD25X** 25x25 cm**356MD25X** Ø25 cm**356SD30X** 30x30 cm**356MD30X** Ø30 cm

BODY JETS



Q34JET

Body jet 4,2x4,2 cm in ottone per sistema doccia, con ugelli in silicone, anticalcare con snodo.
Body jet 4,2x4,2 cm in brass for shower systems, with spray in silicon, antilimestone, with ball-joint.

CR FIN 1 FIN 2



N34JET

Body jet Ø4 cm in ottone per sistema doccia, con ugelli in silicone, anticalcare, con snodo.
Body jet Ø4 cm in brass for shower systems, with spray in silicon, antilimestone, with ball-joint.

CR FIN 1 FIN 2



QX34JETB

Body jet ad incassato 5x5 cm, in acciaio INOX lucidato a specchio per sistema doccia, anticalcare, con snodo.
Built-in body jet 5x5 cm, in stainless steel mirror polished for shower systems, antilimestone, with ball-joint.

CR



AUX34JETB

Body jet da incasso quadrato 8x8 cm, in acciaio INOX lucidato a specchio per sistema doccia, anticalcare.
Built-in squared body jet 8x8 cm, in stainless steel mirror polished for shower systems, antilimestone.

CR



AUX34JETBN

Body jet da incasso quadrato con getto nebulizzato, 8x8 cm, in acciaio INOX lucidato a specchio per sistema doccia, anticalcare.
Built-in squared nebulized body jet, 8x8 cm, in stainless steel mirror.

CR



NX34JETB

Body jet ad incassato Ø5 cm, in acciaio INOX lucidato a specchio per sistema doccia, anticalcare, con snodo.
Built-in body jet Ø5 cm, in stainless steel mirror polished for shower systems, antilimestone, with ball-joint.

CR



NX34JET

Body jet Ø5 cm, in acciaio INOX lucidato a specchio per sistema doccia, anticalcare, con snodo.
Body jet Ø5 cm, in stainless steel mirror polished for shower systems, antilimestone, with ball-joint.

CR



QX34JET

Body jet 5x5 cm, in acciaio INOX lucidato a specchio per sistema doccia, anticalcare, con snodo.
Body jet 5x5 cm, in stainless steel mirror polished for shower systems, antilimestone, with ball-joint.

CR

BOCCE A PARETE

WALL SPOUTS



359XT

Bocca rotonda a incasso con getto a cascata, in acciaio INOX lucidato a specchio.

Rounded built-in spout with waterfall jet, mirror polished stainless steel.

CR



359XS

Soffione/bocca a cascata ad incasso squadrata in acciaio INOX lucidato a specchio.

Squared built-in stainless steel mirror polished waterfall shower head/spout.

CR



359XM

Soffione/bocca a cascata ad incasso con angoli arrotondati in acciaio INOX lucidato a specchio.

Built-in stainless steel mirror polished waterfall shower head/spout with round corners.

CR



359XL

Soffione/bocca a cascata ad L in acciaio INOX lucidato a specchio.

Stainless steel mirror polished "L" waterfall shower head/spout.

CR



359ZC

Soffione doccia in ottone con getto a cascata.

Brass shower head, with waterfall jet.

CR

FIN 1

FIN 2



359NC

Soffione doccia in ottone con getto a cascata bordi arrotondati.

Brass shower head with rounded corners and waterfall jet.

CR

FIN 1

FIN 2



BRACCI DOCCIA SHOWER ARMS



Braccio doccia in ottone con rosetta, 1/2Mx1/2M.
Brass tube shower arm, with wall flange, 1/2Mx1/2M.

		CR	FIN 1	FIN 2
343L30	30 cm			
343L35	35 cm			
343L40	40 cm			



Braccio doccia "Minimal" in ottone, con rosetta, 1/2Mx1/2M.
Brass shower arm "Minimal" with wall flange, 1/2Mx1/2M.

		CR	FIN 1	FIN 2
348N20	20 cm			
348N30	30 cm			
348N40	40 cm			
348N50	50 cm			



Braccio doccia quadrato, completo di rosetta quadrata, completamente in ottone, 1/2Mx1/2M.
Squared shower arm, complete with square wall flange, all in brass, 1/2Mx1/2M.

		CR	FIN 1	FIN 2
348S30	30 cm			
348S40	40 cm			



Braccio doccia Q in ottone, con rosetta, 1/2Mx1/2M.
Brass Q shower arm with wall flange, 1/2Mx1/2M.

		CR
348Q30	30 cm	
348Q40	40 cm	

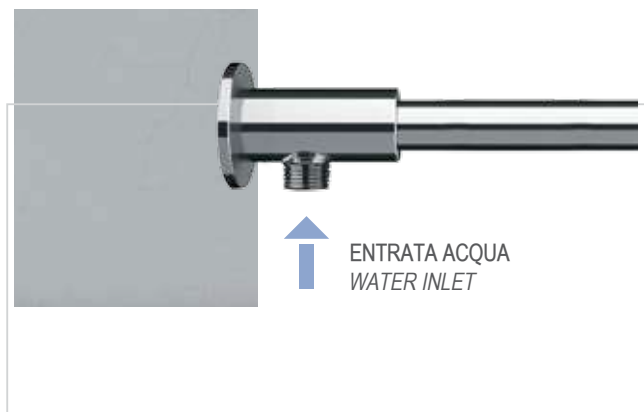

Braccio doccia in ottone 30 cm senza presa acqua a muro ma con attacco flessibile da 1/2" sul braccio. Ideale per ristrutturazioni.
Brass arm 30 cm. without wall pipe connection but with flexible connection 1/2" on the arm. Ideal for renovation.

		CR
348NPB30	30 cm	



Braccio doccia da soffitto, serie Minimal, completamente in ottone cromato, 1/2Mx1/2M.
Ceiling shower arm, Minimal serie, completely in chrome plated brass, 1/2Mx1/2M.

		CR	FIN 1	FIN 2
347N10	10 cm			
347N20	20 cm			
347N30	30 cm			
347N40	40 cm			
347N50	50 cm			



Braccio doccia da soffitto quadrato, completamente in ottone, 1/2Mx1/2M.
Squared ceiling shower arm completely in chrome plated brass, 1/2Mx1/2M.

		CR	FIN 1	FIN 2
347S10	10 cm			
347S20	20 cm			
347S30	30 cm			
347S40	40 cm			
347S50	50 cm			



Braccio doccia Minimal in ottone con rosetta e con deviatore integrato e doppia uscita 1/2 per attacco sia del soffione che del flessibile doccia. 1/2MX1/2MX1/2M.
Shower arm Minimal in c.p. chrome with flange, with integrated diverter with double output 1/2" to connect both the shower head and the shower flexible. 1/2MX1/2MX1/2M.

		CR
348ND20	20 cm	
348ND30	30 cm	
348ND40	40 cm	
348ND50	50 cm	



Braccio doccia in ottone con rosetta, 1/2Mx1/2M.
Brass tube shower arm, with wall flange, 1/2Mx1/2M.

		CR
34320	20 cm	
34330	30 cm	
34340	40 cm	



342
Braccio doccia in ottone, con rosetta, 1/2Mx1/2M.
Brass tube shower arm, with wall flange, 1/2Mx1/2M.

		CR
342		



342S
Braccio doccia in ottone, con rosetta, 1/2Mx1/2M, lunghezza cm 30.
Brass tube shower arm, with wall flange, 1/2Mx1/2M, length cm 30.

		CR
342S		



34620
Braccio doccia, conico, in ottone, cm 20.
Brass cast shower arm, 1/2, cm 20.

		CR
34620		

BOCCHÉ - SPOUTS

BOCCHÉ A SOFFITTO E A MURO CEILING AND WALL SPOUTS



La bocche per incasso o bordo vasca sono un utile strumento per personalizzare la zona della vasca da bagno, abbinando l'estetica e la tipologia di getto ai diversi obiettivi dei singoli progetti.

The built-in or deck-bath spouts are a useful tool for customizing the bathtub area, matching the aesthetics and the type of each solution to the different objectives of each project.



91VLN2

BORDO VASCA
DECK BATH MIXERS

DOCCHETTE
HANDSHOWERS

SALISCENDI
SLIDING RAILS

PANNELLI DOCCIA
SHOWER PANELS

BOCCHIE
SPOUTS

SOFFIONI
SHOWER HEADS

CROMOTERAPIA
COLOR THERAPY

KIT WELLNESS
WELLNESS KIT

COLONNE DOCCIA
SHOWER COLUMNS

TERMOSTATICI
THERMOSTATICS

A PULSANTE
PUSH-BUTTON

BOX INCASSO
BUILT-IN BOX

BOCCHHE A SOFFITTO - CEILING SPOUTS



91VNR

Bocca da soffitto in ottone lunghezza 166 cm, con dispositivo color.
Ceiling spout in chrome plated brass cm 166, with color device.



91VLNR

Bocca da soffitto in ottone lunghezza 181 cm, con dispositivo color.
Ceiling spout in chrome plated brass cm 181, with color device.



91VLN2

Bocca da soffitto in ottone lunghezza 181 cm.
Ceiling spout in chrome plated brass cm 181.



91VN2

Bocca da soffitto in ottone lunghezza 166 cm.
Ceiling spout in chrome plated brass cm 166.



BOCCHHE A CASCATA - WATERFALL SPOUTS



91ZC

Bocca incasso cascata.
Waterfall built-in spout.



91NC

Bocca incasso cascata con bordi arrotondati, serie Minimal.
Waterfall built-in spout with rounded corners, Minimal serie.



91QC

Bocca incasso cascata serie Qubika, cm 18.
Qubika cascade built-in spout, cm 18.





91VNR



91NCNO

BOCCHHE INCASSO - BUILT-IN SPOUTS



91EY
Bocca incasso cm 18, serie Energy.
Energy built-in spout, cm 18.

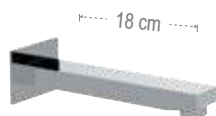

91Q
Bocca incasso serie Qubika, cm 18.
Qubika built-in spout cm 18.

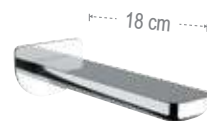

91I
Bocca incasso cm 18, serie Infinity.
Infinity built-in spout, cm 18.



91EYL
Bocca incasso cm 23, serie Energy.
Energy built-in spout, cm 23.



91QL
Bocca incasso serie Qubika, cm 23.
Qubika built-in spout cm 23.



91IL
Bocca incasso cm 23, serie Infinity.
Infinity built-in spout, cm 23.

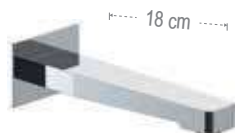

91DR
Bocca incasso serie Dream, cm 18.
Dream built-in spout, cm 18.



91X
Bocca incasso, serie X Style, 16,5 cm.
Built-in spout, X Style serie, 16,5 cm.



91L
Bocca incasso cm 18, serie Class Line.
Class Line built-in spout, cm 18.



91DL
Bocca incasso serie Dream, cm 23.
Dream built-in spout, cm 23.



91XL
Bocca incasso, serie X Style, 19 cm.
Built-in spout, X Style serie, 19 cm.



91LL
Bocca incasso cm 23, serie Class Line.
Class Line built-in spout, cm 23.



91V
Bocca incasso, serie Vanity, 19 cm.
Built-in spout, Vanity serie, 19 cm.



91M
Bocca incasso cm 18, serie Minimal.
Minimal built-in spout, cm 18.



91S
Bocca incasso quadrata cm 18, serie Square.
Square built-in spout, cm 18.

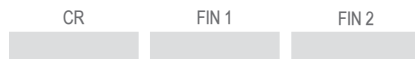



91
Bocca incasso vasca-doccia.
Built-in spout for bath-shower.

CR



91NR
Bocca incasso cm 18, serie Minimal Color.
Minimal Color built-in spout, cm 18.

CR



91QR
Bocca incasso con luce led serie Q Color.
Built-in spout with led light Q Color Serie.

CR



BOCCHE INCASSO CON DEVIATORE INTEGRATO
BUILT-IN SPOUTS WITH INTEGRATED DIVERTER



91LD
Bocca incasso cm 18 con deviatore.
Built-in spout cm 18 with diverter.

CR

FIN 1

FIN 2



91MD
Bocca incasso serie Minimal, cm 18, con deviatore integrato.
Minimal built-in spout cm 18, with diverter.

CR

FIN 1

FIN 2



91QD
Bocca incasso serie Qubika, cm 18, con deviatore integrato.
Qubika built-in spout, with integrated diverter.

CR

FIN 1

FIN 2



91SD
Bocca incasso quadrata cm 18, serie Square con deviatore.
Square built-in spout cm 18, with diverter.

CR

FIN 1

FIN 2



91D
Bocca incasso vasca-doccia, con deviatore integrato.
Built-in spout for bath-shower, with diverter.

CR

PANNELLI DOCCIA - SHOWER PANELS

PANNELLI DOCCIA SHOWER PANELS



I pannelli doccia sono soluzioni complete per l'interno doccia che integrano tutte le funzioni nell'eleganza di un unico elemento. Disponibili, a seconda del modello, con miscelazione tradizionale e termostatica e con i comfort aggiuntivi di getto a cascata e body-jets (verificare le specifiche tecniche dei singoli articoli).

The shower panels are complete solutions for the shower interior that integrate all the functions within the elegance of a single element. Available, depending on the model, with traditional and thermostatic mixing and with the additional comforts of waterfall jet and body-jets (check the technical specifications of the individual items).



PANNELLI DOCCIA - SHOWER PANELS



330QM20

Pannello doccia a parete, monocomando con deviatore a 2 vie, in acciaio INOX lucidato a specchio, getto a pioggia anticalcare, doccetta anticalcare in ABS cromato, flessibile in PVC da 150 cm.

Stainless steel mirror polished wall mounted shower panel, single lever with 2 ways diverter, rain jet with antilimestone system, c.p. ABS handshower with antilimestone system, PVC flexible hose 150 cm.

CR



330QM20J

Pannello doccia a parete, monocomando con deviatore a 3 vie, in acciaio INOX lucidato a specchio, getto a pioggia anticalcare, body jets anticalcare, doccetta anticalcare in ABS cromato, flessibile in PVC da 150 cm.

Stainless steel mirror polished wall mounted shower panel, single lever with 3 ways diverter, rain jet with antilimestone system, antilimestone body jets, c.p. ABS handshower with antilimestone system, PVC flexible hose 150 cm.

CR



330QM20JC

Pannello doccia a parete, monocomando con deviatore a 4 vie, in acciaio INOX lucidato a specchio, getto a pioggia anticalcare e getto a cascata, body jets anticalcare, doccetta anticalcare in ABS cromato, flessibile in PVC da 150 cm.

Stainless steel mirror polished wall mounted shower panel, single lever with 4 ways diverter, rain jet with antilimestone system, waterfall jet, antilimestone body jets, c.p. ABS handshower with antilimestone system, PVC flexible hose 150 cm.

CR



PANNELLI DOCCIA AD INCASSO - BUILT-IN SHOWER PANELS

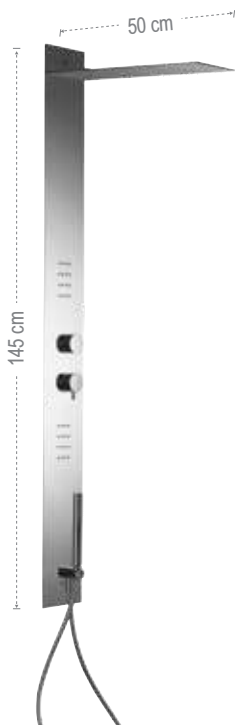

330QI15J

Pannello doccia ad incasso, monocomando con deviatore a 3 vie, in acciaio INOX lucidato a specchio, getto a pioggia anticalcare, body jets anticalcare, doccetta anticalcare in ABS cromato, flessibile in PVC da 150 cm.

Stainless steel mirror polished wall mounted shower panel, single lever with 3 ways diverter, rain jet with antilimestone system, antilimestone system body jets, c.p. ABS handshower with antilimestone system, PVC flexible hose 150 cm.

CR



330QIT15J

Pannello doccia ad incasso termostatico, monocomando con deviatore a 3 vie, in acciaio INOX lucidato a specchio, getto a pioggia anticalcare, body jets anticalcare, doccetta anticalcare in ABS cromato, flessibile in PVC da 150 cm.

Stainless steel mirror polished wall mounted thermostatic shower panel, single lever with 3 ways diverter, rain jet with antilimestone system, antilimestone system body jets, c.p. ABS handshower with antilimestone system, PVC flexible hose 150 cm.

CR



PANNELLI DOCCIA TERMOSTATICI - THERMOSTATIC SHOWER PANELS

**330QMT20**

Pannello doccia a parete termostatico coassiale, monocomando con deviatore a 2 vie, in acciaio INOX lucidato a specchio, getto a pioggia anticalcare, doccetta anticalcare in ABS cromato, flessibile in PVC da 150 cm.

Stainless steel mirror polished wall mounted thermostatic coaxial shower panel, single lever with 2 ways diverter, rain jet with antilimestone system, c.p. ABS handshower with antilimestone system, PVC flexible hose 150 cm.

CR

**330QMT20J**

Pannello doccia a parete termostatico, monocomando con deviatore a 3 vie, in acciaio INOX lucidato a specchio, getto a pioggia anticalcare, body jets anticalcare, doccetta anticalcare in ABS cromato, flessibile in PVC da 150 cm.

Stainless steel mirror polished wall mounted thermostatic shower panel, single lever with 3 ways diverter, rain jet with antilimestone system, antilimestone system body jets, c.p. ABS handshower with antilimestone system, PVC flexible hose 150 cm.

CR

**330QMT20JC**

Pannello doccia a parete termostatico, monocomando con deviatore a 4 vie, in acciaio INOX lucidato a specchio, getto a pioggia anticalcare e getto a cascata, body jets anticalcare, doccetta anticalcare in ABS cromato, flessibile in PVC da 150 cm.

Stainless steel mirror polished wall mounted thermostatic shower panel, single lever with 4 ways diverter, rain jet with antilimestone system, waterfall jet, antilimestone system body jets, c.p. ABS handshower with antilimestone system, PVC flexible hose 150 cm.

CR

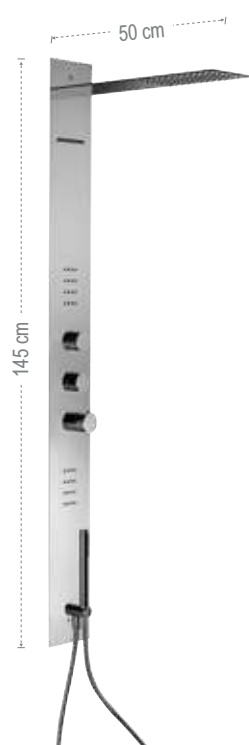
**330QIT15JC**

Pannello doccia ad incasso termostatico, monocomando con deviatore a 4 vie, in acciaio INOX lucidato a specchio, getto a pioggia anticalcare, getto cascata, body jets anticalcare, doccetta anticalcare in ABS cromato, flessibile in PVC da 150 cm.

Stainless steel mirror polished wall mounted thermostatic shower panel, single lever with 4 ways diverter, rain jet with antilimestone system, waterfall jet, antilimestone system body jets, c.p. ABS handshower with antilimestone system, PVC flexible hose 150 cm.

CR



SALISCENDI - SLIDING RAILS

SALISCENDI SLIDING RAILS



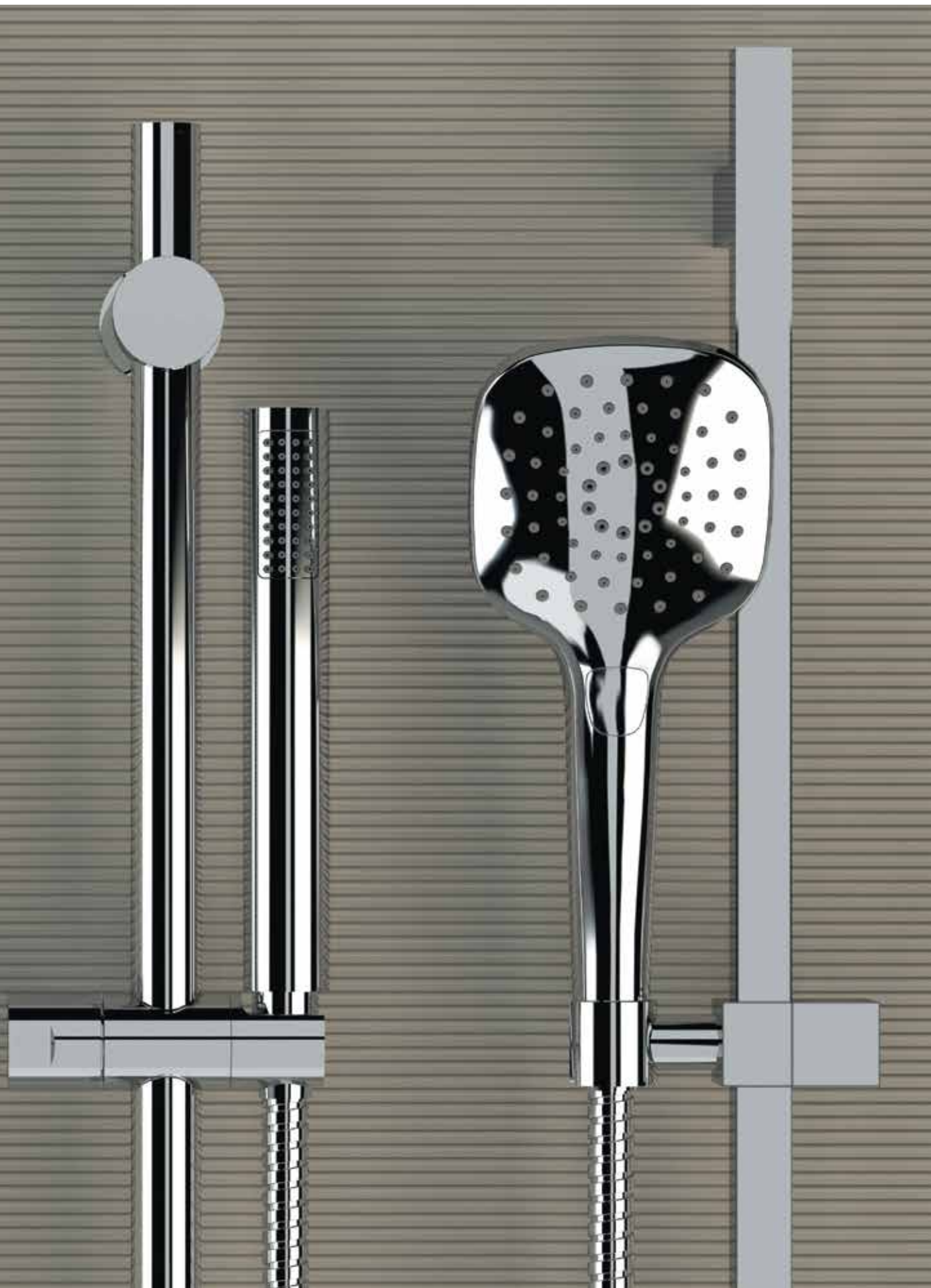

BORDO VASCA
DECK BATH MIXERS

DOCLETTE
HANDSHOWERS

SALISCENDI
SLIDING RAILS

PANNELLI DOCCIA
SHOWER PANELS

BOCCHE
SPOUTS

SOFFIONI
SHOWER HEADS

CROMOTERAPIA
COLORTHERAPY

KIT WELLNESS
WELLNESS KIT

COLONNE DOCCIA
SHOWER COLUMNS

TERMOSTATICI
THERMOSTATICS

A PULSANTE
PUSH-BUTTON

BOX INCASSO
BUILT-IN BOX

BLACK VERSION



317ID8MPNO

Set saliscendi in nero opaco composto da asta saliscendi in metallo/abs con fissaggio superiore regolabile, doccetta in abs nero a 3 funzioni con pulsante per il cambio dei getti, flessibile 150cm.

Matt black metal/abs sliding rail set including sliding rail with adjustable upper fixing, black abs 3-function hand-shower with button for jets mode switching, 150cm flexible hose.

CR

NO



317ID8CPNO

Set saliscendi in nero opaco composto da asta saliscendi in metallo/abs con fissaggio superiore regolabile, doccetta in abs nero a 3 funzioni con pulsante per il cambio dei getti, flessibile 150cm.

Matt black sliding rail set including metal/abs sliding rail with adjustable upper fixing, black abs 3-function hand-shower with button for jets mode switching, 150cm flexible hose.

CR

NO



317ID7MDNO

Set saliscendi in nero opaco composto da asta saliscendi in metallo/abs con fissaggio superiore regolabile, doccetta in abs nero a 1 funzione, flessibile 150cm.

Matt black sliding rail set including metal/abs sliding rail with adjustable upper fixing, black abs 1-function hand-shower, 150cm flexible hose.

CR

NO



317S317AU

Saliscendi SQ con doccetta ad 1 funzione tutto in ottone, flessibile 150 cm.

SQ sliding rail set with 1 function handshower all in brass, flexible hose 150 cm.

CR

FIN 1

FIN 2



317G317MC

Saliscendi con asta tonda e fissaggio superiore scorrevole, doccetta in ottone a 1 funzione e flessibile 150 cm.

Sliding rail with round rod and sliding top fixing, 1-function brass handshower and 150 cm flexible hose.

CR

FIN 1

FIN 2



317L323CR

Saliscendi Liberty, tutto in ottone con asta tonda e doccetta ad 1 funzione modello liberty, flessibile 150 cm.

Liberty sliding rail set all in brass, with round rod and liberty 1 function handshower, flexible hose 150 cm.

CR

FIN 1

FIN 2



315L318MP

Saliscendi minimale con doccetta anticalcar in ABS a 3 funzioni con pulsante cambio getti, flessibile 150 cm.

Minimal sliding rail set with antilimestone ABS 3 function handshower, with button to change jets, flexible hose 150 cm.

CR



315L318CP

Saliscendi minimale con doccetta anticalcar in ABS a 3 funzioni con pulsante cambio getti, flessibile 150 cm.

Minimal sliding rail set with antilimestone ABS 3 function handshower, with button to change jets, flexible hose 150 cm.

CR



317M317MD

Saliscendi minimale con doccetta in ABS anticalcare, flessibile 150 cm.

Minimal sliding rail set with antilimestone ABS handshower, flexible hose 150 cm.

CR



**317S317SD**

Saliscendi quadro tutto in ottone con doccetta anticalcare ad 1 funzione in ABS, flessibile in ottone cm 150.

Sliding bar all brass, with 1 function antilimestone ABS handshower, flexible hose 150 cm.

CR

**317S317SQ**

Saliscendi quadro tutto in ottone con doccetta anticalcare ad 1 funzione in ABS, flessibile in ottone cm 150.

Sliding bar all brass, with 1 function antilimestone ABS handshower, flexible hose 150 cm.

CR

**317R317RR**

Saliscendi e doccetta ad 1 funzione tutto ottone serie ultrapiatta rettangolare, flessibile 150 cm.

Sliding rail and 1 function handshower serie ultrathin rectangular, all in brass, flexible hose 150 cm.

CR

**315R318MP**

Saliscendi cromato con asta tonda minimale e doccetta in ABS a 3 funzioni con pulsante per cambio dei getti, anticalcare, flessibile 150 cm.

C.p. sliding rail set with minimal round rod and 3 functions antilimestone ABS handshower with button to change the jets, flexible hose 150 cm.

CR

**315R318CP**

Saliscendi cromato con asta tonda minimale e doccetta in ABS a 3 funzioni con pulsante cambio getti, anticalcare, flessibile 150 cm.

C.p. sliding rail set with minimal round rod and ABS antilimestone 3 functions handshower with button to change jets, flexible hose 150 cm.

CR

**315R319MO**

Saliscendi cromato asta tonda, doccetta in ABS anticalcare a 3 funzioni, flessibile 150 cm.

Sliding rail set with round rod and antilimestone 3 functions handshower and flexible hose 150 cm.

CR

**317M319MO**

Saliscendi minimale con doccetta anticalcare in ABS a 3 funzioni, flessibile 150 cm.

Minimal sliding rail set with ABS antilimestone 3 functions handshower, flexible hose 150 cm.

CR

**311F315P3**

Saliscendi cromato con asta tonda e doccetta anticalcare in ABS a 3 funzioni con pulsante cambio getti, flessibile 150 cm.

C.p. sliding rail set with round rod and ABS antilimestone 3 functions handshower with button to change jets, flexible hose 150 cm.

CR

**317V317RV**

Saliscendi cromato con asta minimale ovale dritta e doccetta anticalcare in ABS ad 1 funzione, flessibile 150 cm.

C.p. sliding rail set with minimal oval rod and antilimestone ABS 1 function handshower, flexible hose 150 cm.

CR





**317V315P3**

Saliscendi cromato con asta minimale ovale, doccia in ABS anticalcare a 3 funzioni, pulsante cambio getti, anticalcare, flessibile 150 cm.

C.p. sliding rail set with minimal oval rod and antilimestone ABS 3 functions handshower with button to change jets, flexible hose 150 cm.

CR

**311D318F4**

Saliscendi con doccia cromata a 5 funzioni con getti in silicone, anticalcare, flessibile 150 cm.

Sliding rail set with c.p. handshower 5 functions anti-limestone with silicon jets, flexible hose 150 cm.

CR

**311D318F5**

Saliscendi con doccia in ABS a 5 funzioni e getti in silicone, anticalcare, flessibile 150 cm.

Sliding rail set with ABS handshower 5 functions, antilimestone with silicon jets and flexible hose 150 cm.

CR

**311D315C3**

Saliscendi con doccia in ABS anticalcare ad 2 funzioni, flessibile 150 cm.

Sliding rail set with antilimestone ABS 2 function handshower, flexible hose 150 cm.

CR

**3143120V**

Saliscendi cromato con barra tonda e doccia anticalcare in ABS a 3 funzioni, flessibile 150 cm.

C.P. sliding rail set with round bar and antilimestone ABS 3 functions handshower, flexible hose 150 cm.

CR

**311D311DA**

Saliscendi cromato minimale con asta tonda e doccia in ABS anticalcare ad 1 funzione, flessibile 150 cm.

C.p. sliding rail with round rod and 1 function ABS antilimestone handshower, flexible hose 150 cm.

CR

**311311DA**

Saliscendi con doccia in ABS anticalcare ad 1 funzione, flessibile 150 cm.

Sliding rail set with antilimestone ABS 1 function handshower, flexible hose 150 cm.

CR

**311D312**

Saliscendi cromato con asta tonda e doccia ad 1 funzione in ABS anticalcare, flessibile 150 cm.

C.P. sliding rail set with swiveling rail and 1 function ABS antilimestone handshower, flexible hose 150 cm.

CR



SALISCENDI CM 90 CON DOCCIA, ALCUNE COMBINAZIONI
SLIDING RAILS CM 90 WITH HANDSHOWERS, SOME EXAMPLE OF COUPLINGS



319D321GR

Saliscendi cm 90 con doccetta in ABS anticalcare a 4 funzioni, flessibile 200 cm.
Sliding rail set cm 90 with ABS antilimestone handshower 4 functions, flexible hose 200 cm.

CR



319G319MO

Saliscendi cm 90 con doccetta grande a disco in ABS anticalcare a 3 funzioni, flessibile 200 cm.
Sliding rail set cm 90 with ABS antilimestone handshower 3 functions, and flexible hose 200 cm.

CR

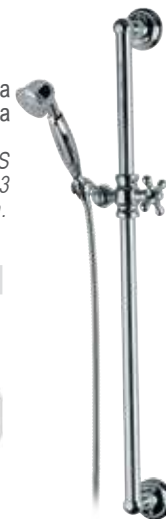

319L323CR

Saliscendi Liberty lusso cm 90, completamente in ottone, con asta tonda e doccetta ad 1 funzione modello liberty, flessibile 200 cm.
Sliding rail set all in brass cm 90 with handshower 1 functions, flexible hose 200 cm.

CR



ASTA CROMATA +
CHROME PLATED ROD



315L333

Saliscendi cromato con asta tonda minimale Ø 22 mm e centralina in ABS, con flessibile in ottone 150 cm senza doccetta, in scatola con finestra. Altezza 69 cm.
Sliding rail set with round minimal rod Ø 22 mm and sliding shower holder, with brass flexible hose 150 cm, without handshower, in box. Height 69 cm.

CR



317M333

Saliscendi in ottone con asta tonda minimale Ø 18 mm e centralina in ABS, con flessibile in ottone 150 cm senza doccetta, in scatola con finestra. Altezza 60 cm.
Sliding rail set in Brass with round minimal rod Ø 18 mm and ABS sliding shower holder, with brass flexible hose 150 cm, without handshower, in box. Height 60 cm.

CR



311S333

Saliscendi cromo-satinato con asta tonda Ø 25 mm e centralina in ABS, con flessibile in ottone 150 cm, senza doccetta, in scatola con finestra. Altezza 66 cm.
Sliding rail set in chrome-satin with round rod Ø 25 mm and ABS sliding shower holder, with brass flexible hose, without handshower, in box. Height 66 cm.

CR



311333

Saliscendi cromato con asta tonda Ø 25 mm e centralina in ABS, flessibile in ottone 150 cm, senza doccetta, in scatola con finestra. Altezza 62 cm.
Sliding rail set with round rod Ø 25 mm and ABS sliding shower holder, with brass flexible hose 150 cm, without handshower, in box. Height 62 cm.

CR



317S333

Saliscendi completamente in ottone da barra quadrata con centralina, flessibile 150 cm, senza doccetta, in scatola con finestra. Altezza 70 cm.
Sliding rail set all in brass, squared rod with sliding shower holder, flexible hose 150 cm, without handshower, in box. Height 70 cm.

CR

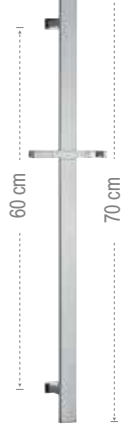

317R333

Saliscendi lusso Flat ultrapiatto tutto in ottone, asta rettangolare piatta larga mm 30 con centralina, flessibile 150 cm, senza doccetta, in scatola con finestra. Altezza 70 cm.
Deluxe sliding rail Flat line all in brass, rectangular flat rod large mm 30 and sliding shower holder, flexible hose 150 cm, without handshower, in box with window. Height 70 cm.

CR

**315R333**

Saliscendi in ottone con asta tonda minimale Ø 25 mm e centralina in ABS, con flessibile in ottone 150 cm senza doccetta, in scatola con finestra. Altezza 69 cm.

Sliding rail set in Brass with round minimal rod Ø 25 mm and sliding shower holder, with brass flexible hose 150 cm, without handshower, in box. Height 69 cm.

CR

319R333

Con asta 90 cm.
With rod 90 cm.

CR

**317L333**

Saliscendi Liberty lusso tutta in ottone, asta tonda Ø 25 mm con centralina, con flessibile 150 cm, senza doccetta, in scatola con finestra. Altezza 60 cm.

Deluxe sliding rail Liberty line all in brass, round rod Ø 25 mm with sliding shower holder, flexible hose 150 cm, without handshower, in box with window. Height 60 cm.

CR

319L333

Con asta 90 cm.
With rod 90 cm.

CR

**311D333**

Saliscendi cromato con asta tonda Ø 25 mm e centralina in ABS, flessibile in ottone 150 cm, senza doccetta, in scatola con finestra. Altezza 60 cm.

Sliding rail set with round rod Ø 25 mm and ABS sliding shower holder, with brass flexible hose, without handshower, in box. Height 60 cm.

CR

319D333

Con asta 94 cm.
With rod 94 cm.

CR



SUPPORTO REGOLABILE
ADJUSTABLE HOLDER

**317N333**

Saliscendi tutto in ottone, asta tonda Ø 25 mm con centralina, flessibile 150 cm, senza doccetta, in scatola con finestra. Altezza 70 cm.

Deluxe sliding rail all in brass, with round rod Ø 25 mm and sliding shower holder, flexible hose 150 cm, without handshower, in box. Height 70 cm.

CR

**317G333**

Saliscendi tutto in ottone, asta tonda Ø 25 mm e centralina, con flessibile 150 cm, senza doccetta, in scatola con finestra. Altezza 70 cm.

Deluxe sliding rail, all in brass, with round rod Ø 25 mm and sliding shower holder, with flexible hose 150 cm, without handshower, in box. Height 70 cm.

CR

319G333

Con asta 87 cm.
With rod 87 cm.

CR

PORTASAPONE - SOAP HOLDER**319PR**

Portasapone cromato per saliscendi con asta tonda Ø 25.
C.p. soap-holder for sliding rail with round rod Ø 25.

CR

**311PC**

Portasapone cromato economico per saliscendi tipo art. 310, 311 e 314, per asta Ø 25 mm e Ø 18 mm.

Chrome plated soap holder for sliding rails like art. 310, 311 and 314, for round rod Ø 25 mm and Ø 18 mm.

CR

**311PS**

Portasapone per saliscendi art. 310 e 311, per asta Ø 24 o 25 mm.
Soap holder for sliding rail art. 310 or 311, for round rod Ø 24 or 25 mm.

CR

DOCETTE - HAND SHOWERS

DOCETTE HAND SHOWERS





BORDO VASCA
DECK BATH MIXERS

DOCLETTE
HANDSHOWERS

SALISCENDI
SLIDING RAILS

PANNELLI DOCCIA
SHOWER PANELS

BOCCHE
SPOUTS

SOFFIONI
SHOWER HEADS

CROMOTERAPIA
COLORTHERAPY

KIT WELLNESS
WELLNESS KIT

COLONNE DOCCIA
SHOWER COLUMNS

TERMOSTATICI
THERMOSTATICS

A PULSANTE
PUSH-BUTTON

BOX INCASSO
BUILT-IN BOX

KIT SUPPORTO CON PRESA ACQUA E DOCCETTA
HANDSHOWER AND WATER PUNCH WITH SHOWER HOLDER KIT



337M317MC

Set doccia minimale composto da: presa acqua con supporto lusso in ottone, doccetta in ottone e flessibile 150 cm.

Minimal shower set including: water punch and shower holder in brass, brass handshower and 150 cm flexible hose.

CR

FIN 1

FIN 2



337Q317AU

Set doccia quadrato composto da: presa acqua con supporto lusso in ottone, doccetta in ottone e flessibile 150 cm.

Squared shower set including: water punch and shower holder in brass, brass handshower and 150 cm flexible hose.

CR

FIN 1

FIN 2



337M318MP

Set doccia composto da: presa acqua con supporto lusso in ottone, doccetta cromata a 3 funzioni, con pulsante per cambio dei getti, anticalcare con getti in silicone e flessibile 150 cm.

Shower set including: water punch and shower holder in brass, handshower 3 functions with button to change the jets, antilimestone with silicon jets and 150 cm flexible hose.

CR



337M317MD

Set doccia minimale composto da: presa acqua con supporto lusso in ottone, doccetta cromata, anticalcare con getti in silicone e flessibile 150 cm.

Minimal shower set including: water punch and shower holder in brass, handshower antilimestone with silicon jets and 150 cm flexible hose.

CR



337Q317SD

Set doccia quadrato composto da: presa acqua con supporto lusso in ottone, doccetta anticalcare in ABS, e flessibile 150 cm.

Shower set including: water punch and shower holder in brass, antilimestone ABS handshower and 150 cm flexible hose.

CR



337Q317SQ

Set doccia Qubika composto da: presa acqua con supporto lusso in ottone, doccetta cromata anticalcare con getti in silicone e flessibile 150 cm.

Qubika shower set including: water punch and shower holder in brass, handshower antilimestone with silicon jets and 150 cm flexible hose.

CR



337Q318CP

Set doccia quadrato composto da: presa acqua con supporto lusso in ottone, doccetta cromata a 3 funzioni, con pulsante per cambio dei getti, anticalcare con getti in silicone e flessibile 150 cm.

Shower set including: water punch and shower holder in brass, handshower 3 functions with button to change the jets, antilimestone with silicon jets and 150 cm flexible hose.

CR



337M319MO

Set doccia composto da: presa acqua con supporto lusso in ottone, doccetta cromata 3 funzioni, idromassaggio, anticalcare con getti in silicone e flessibile 150 cm.

Shower set including: water punch and shower holder in brass, 3 functions handshower antilimestone with silicon jets, hydromassage, and 150 cm flexible hose.

CR



337M318CP

Set doccia composto da: presa acqua con supporto lusso in ottone, doccetta cromata a 3 funzioni, con pulsante per cambio dei getti, anticalcare con getti in silicone e flessibile 150 cm.

Shower set including: water punch and shower holder in brass, handshower 3 functions with button to change the jets, antilimestone with silicon jets and 150 cm flexible hose.

CR

PER SET MISCELATORE A INCASSO 54D2, 54D3 - FOR BUILT-IN MIXER SET 54D2, 54D3

**337XC317MC**

Set doccia composto da: presa acqua con supporto lusso in ottone, doccetta in ottone e flessibile 150 cm.

Shower set including: water punch and shower holder in brass, brass handshower and 150 cm flexible hose..

CR

FIN 1

FIN 2

**337AUC317AU**

Set doccia quadrato composto da: presa acqua con supporto lusso in ottone, doccetta in ottone e flessibile 150 cm.

Squared shower set including: water punch and shower holder in brass, brass handshower and 150 cm flexible hose.

CR

FIN 1

FIN 2

BLACK VERSION**337M317MDNO**

Set doccia minimale in nero opaco composto da: presa acqua con supporto lusso in ottone, doccetta cromata, anticalcare con getti in silicone e flessibile 150 cm.

Black matt minimal shower set including: water punch and shower holder in brass, handshower antilimestone with silicon jets and 150 cm flexible hose.

NO

**337M318MPNO**

Set doccia in nero opaco composto da: presa acqua con supporto lusso in ottone, doccetta cromata a 3 funzioni, con pulsante per cambio dei getti, anticalcare con getti in silicone e flessibile 150 cm.

Black matt shower set including: water punch and shower holder in brass, handshower 3 functions with button to change the jets, antilimestone with silicon jets and 150 cm flexible hose.

NO

**337Q317SDNO**

Set doccia quadrato in nero opaco composto da: presa acqua con supporto lusso in ottone, doccetta anticalcare in ABS, e flessibile 150 cm.

Black matt shower set including: water punch and shower holder in brass, antilimestone ABS handshower and 150 cm flexible hose.

NO

**337Q318CPNO**

Set doccia quadrato in nero opaco composto da: presa acqua con supporto lusso in ottone, doccetta cromata a 3 funzioni, con pulsante per cambio dei getti, anticalcare con getti in silicone e flessibile 150 cm.

Black matt shower set including: water punch and shower holder in brass, handshower 3 functions with button to change the jets, antilimestone with silicon jets and 150 cm flexible hose.

NO

DOCCETTE - HANDSHOWERS

BLACK VERSION



Doccetta nera, 3 funzioni, pulsante per cambio dell'intensità del getto, anticalcare.
C.p. handshower 3 functions, button to change intensity of the jets, antilimestone.

318CPNO Senza scatola - Without box
 NO

318CPNOX Con scatola - With box
 NO

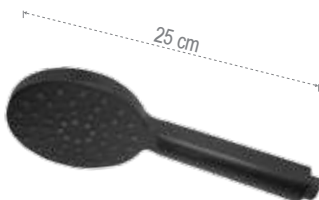

Doccetta nera 3 funzioni, pulsante cambio getti, anticalcare.
C.P. handshower 3 functions, button to change the jets, antilimestone.

318MPNO Senza scatola - Without box
 NO

318MPNOX Con scatola - With box
 NO

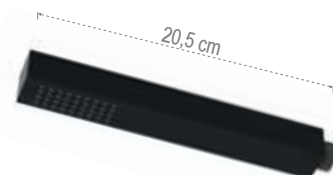

Doccetta quadrata ad 1 funzione in ABS.
1 function ABS handshower.

317SDNO Senza scatola - Without box
 NO

317SDNOX Con scatola - With box
 NO



Doccetta minimal ad 1 funzione, anticalcare.
C.P. minimal handshower 1 function antilimestone.

317MDNO Senza scatola - Without box
 NO

317MDNOX Con scatola - With box
 NO





Doccetta Minimal ad 1 funzione completamente in ottone.
1 function minimal handshower, completely in brass.

317MC Senza scatola - Without box
CR FIN 1 FIN 2

317MCX Con scatola - With box
CR FIN 1 FIN 2



Doccetta quadrata ad 1 funzione, in ottone.
1 function handshower, in brass.

317AU Senza scatola - Without box
CR FIN 1 FIN 2

317AUX Con scatola - With box
CR FIN 1 FIN 2



Doccetta "Liberty" in ottone cromato.
C.p. brass "Liberty" handshower.

323CR Senza scatola - Without box
CR FIN 1 FIN 2

323CRX Con scatola - With box
CR FIN 1 FIN 2



Doccetta cromata, 3 funzioni, pulsante per cambio dell'intensità del getto, anticalcare.
C.p. handshower 3 functions, button to change intensity of the jets, antilimestone.



318CP Senza scatola - Without box
CR

318CPX Con scatola - With box
CR

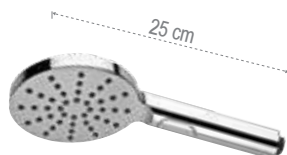

Doccetta cromata 3 funzioni, pulsante cambio getti, anticalcare.
C.P. handshower 3 functions, button to change the jets, antilimestone.



318MP Senza scatola - Without box
CR

318MPX Con scatola - With box
CR

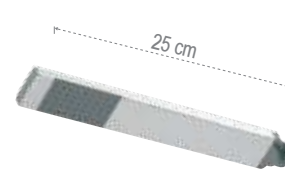

Doccetta rettangolare Flat, 1 funzione, in ottone.
1 function ultraflat rectangular handshower, in brass.



317RR Senza scatola - Without box
CR

317RRX Con scatola - With box
CR



Doccetta minimal ad 1 funzione, anticalcare.
C.P. minimal handshower 1 function antilimestone.



317MD Senza scatola - Without box
CR

317MDX Con scatola - With box
CR

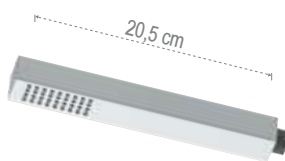

Doccetta quadrata ad 1 funzione in ABS.
1 function ABS handshower.



317SD Senza scatola - Without box
CR

317SDX Con scatola - With box
CR



Doccetta cromata, 3 funzioni, pulsante per cambio getti, anticalcare.
C.P. handshower 3 functions, button to change the jets, antilimestone.



315P3 Senza scatola - Without box
CR

315P3X Con scatola - With box
CR

DOCCETTE - HAND SHOWERS

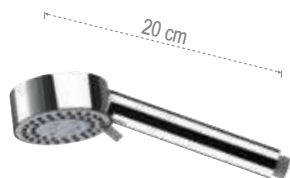

Doccetta cromata minimale 3 funzioni, idromassaggio ed anticalcare.
C.p. handshower 3 functions, hydromassage, antilimestone.



319MO Senza scatola - Without box
CR

319MOX Con scatola - With box
CR



Doccetta cromata Qubika ad 1 funzione, anticalcare.
C.p. Qubika handshower, 1 function, antilimestone.



317SQ Senza scatola - Without box
CR

317SQX Con scatola - With box
CR



Doccetta cromata arcuata ad 1 funzione, anticalcare.
C.p. arch handshower, 1 function antilimestone.



317MR Senza scatola - Without box
CR

317MRX Con scatola - With box
CR



Doccetta cromata "cascata" a 2 funzioni, anticalcare.
C.p. "waterfall" handshower 2 functions, antilimestone.



318CA Senza scatola - Without box
CR

318CAX Con scatola - With box
CR



Doccetta cromata a 5 funzioni, anticalcare.
C.p. handshower 5 functions, antilimestone.



318F4 Senza scatola - Without box
CR

318F4X Con scatola - With box
CR



Doccetta cromata a 5 funzioni, anticalcare.
C.p. handshower 5 functions, antilimestone.



318F5 Senza scatola - Without box
CR

318F5X Con scatola - With box
CR



Doccetta cromata a 4 funzioni, idromassaggio ed anticalcare.
C.p. handshower 4 functions, hydromassage, antilimestone.



318DK Senza scatola - Without box
CR

318DKX Con scatola - With box
CR



Doccetta cromata ovale ad 1 funzione, anticalcare.
C.p. oval handshower 1 function, antilimestone.



317RV Senza scatola - Without box
CR

317RVX Con scatola - With box
CR



Doccetta idromassaggio anticalcare a 4 funzioni.
C.P. handshower 4 functions, hydromassage, antilimestone.



321GR Senza scatola - Without box
CR

321GRX Con scatola - With box
CR

PRESE ACQUA CON SUPPORTO - WATER PUNCHES WITH SHOWER HOLDER

**337X**

Preso acqua e supporto lusso minimale in ottone ad incasso, con rosone ultrapiatto per flessibile con attacco conico.

Water punch and minimal shower holder in brass with ultraflat flange, for built-in and conical nut flexible hose.

CR FIN 1 FIN 2

**337M**

Preso acqua in ottone cromato, con supporto per doccetta. Per flessibile da 1/2" con attacco conico.

C.p. brass wall connection with handshower holder. For 1/2" flexible hose with conical connection.

CR FIN 1 FIN 2

**337Q**

Preso acqua squadrata in ottone cromato, con supporto per doccetta. Per flessibile da 1/2" con attacco conico.

C.p. brass squared wall connection with handshower holder. For 1/2" flexible hose with conical connection.

CR FIN 1 FIN 2

**337W**

Preso acqua rettangolare in ottone cromato, con supporto per doccetta. Per flessibile da 1/2" con attacco conico.

C.p. brass rectangular wall connection with handshower holder. For 1/2" flexible hose with conical connection.

CR FIN 1 FIN 2

**337S**

Preso acqua squadrata in ottone cromato, con supporto orientabile per doccetta. Per flessibile da 1/2" con attacco conico.

C.p. brass squared wall connection with adjustable handshower holder. For 1/2" flexible hose with conical connection.

CR FIN 1 FIN 2

RUBINETTI DI ARRESTO CON SUPPORTO - ANGLE VALVES WITH HOLDER

**338M**

Rubinetto d'arresto serie "Minimal", con supporto doccia in ottone, per flessibile con attacco conico.

Minimal series angle valve with brass handshower holder, for flexible hose with conical connection.

CR

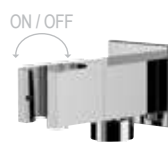
**338Q**

Rubinetto d'arresto quadrato, con supporto doccia in ottone, per flessibile con attacco conico.

Square angle valve with brass handshower holder, for flexible hose with conical connection.

CR

**336L**

Rubinetto d'arresto serie "Minimal", con supporto doccia in ottone, per flessibile con attacco conico.

Brass minimal angle valve with shower holder, for conical nut flexible hose.

CR

**336S**

Rubinetto d'arresto serie "SQ", con supporto doccia in ottone, flessibile con attacco conico.

Brass squared angle valve with shower holder, for conical nut flexible hose.

CR

PRESE ACQUA - WATER PUNCH



309W

Attacco presa acqua da 1/2, tipo rettangolare.
1/2 rectangular wall connection.

CR

FIN 1

FIN 2



309L

Attacco presa acqua da 1/2, tipo rotondo pesante.
Brass wall connector, round heavy type, 1/2Fx1/2M, for shower.

CR

FIN 1

FIN 2



309S

Attacco presa acqua da 1/2Fx1/2M, tipo quadrato, pesante.
Brass wall water punch connector, squared and heavy type, 1/2Fx1/2M, for shower.

CR

FIN 1

FIN 2



309

Angolo 1/2Mx1/2M in ottone, con rosone scorrevole in ottone.
Brass angle 1/2Mx1/2M for shower, with Brass sliding flange.

CR



309RL6

Raccordo doccia 1/2" a risparmio idrico con limitatore di portata da 6 litri al minuto.
Brass connection, water saving program with flow reduction at 6 liters by minute.

CR



309RL8

Raccordo doccia 1/2" a risparmio idrico con limitatore di portata da 8 litri al minuto.
Brass connection, water saving program with flow reduction at 8 liters by minute.

CR



309NR

Raccordo doccia da 1/2" con valvola di non ritorno.
1/2" shower connection with no return valve.

CR

SUPPORTI DOCCIA - SHOWER HOLDERS

**339SOM**

Supporto "minimale" in ottone per flessibile con attacco conico.

Minimal shower holder in brass, for conical nut flexible hose.

CR FIN 1 FIN 2

**339SO**

Supporto "Lux" in ottone, per flessibile con attacco conico.

Shower holder in brass "Lux", for conical shower flexible hose.

CR FIN 1 FIN 2

**339SOS**

Supporto fisso quadrato in ottone per flessibile con attacco conico.

Squared shower holder in brass, for conical nut flexible hose.

CR FIN 1 FIN 2

**338**

Supporto snodato in ottone "Liberty" per duplex esterno, con attacco conico.

Brass adjustable shower holder "Liberty", external duplex, for conical nut flexible hose.

CR FIN 1 FIN 2

**339SS**

Supporto snodato a braccio serie "SQ", in ottone, per flessibile con attacco conico.

Adjustable shower holder serie "SQ" in brass, for conical nut flexible hose.

CR FIN 1 FIN 2

**339**

Supporto snodato in ABS cromato, per flessibile con attacco conico.

Adjustable shower holder in c.p. Abs, for conical nut flexible hose.

CR

**339F**

Supporto fisso in ABS cromato, per flessibile con attacco conico.

Shower holder in c.p. Abs, for conical nut flexible hose.

CR

**339S**

Supporto snodato a braccio serie "SQ", in ABS cromato, per flessibile con attacco conico.

Adjustable shower holder serie "SQ" in c.p. Abs, for conical nut flexible hose.

CR

**339R3**

Supporto fisso a 3 posizioni in ABS cromato per flessibile con attacco conico.

Shower holder 3 positions in CP Abs, for conical nut flexible hose.

CR

**339N**

Supporto snodato a braccio serie "Minimal", in ABS cromato, per flessibile con attacco conico.

Adjustable shower holder serie "Minimal" in c.p. Abs, for conical nut flexible hose.

CR

**339L**

Supporto "minimale" snodato a braccio in ABS cromato, per flessibile con attacco conico.

Adjustable "Minimal" shower holder in c.p. Abs, for conical nut flexible hose.

CR

**325**

Curva in ottone per doccetta, 1/2.

Elbow connection in brass for handshower, 1/2".

CR

**335P**

Supporto snodato in ABS cromato, per flessibile con attacco conico e zigrinato.

Adjustable shower holder in c.p. Abs, for conical nut flexible hose.

CR

**336**

Supporto snodato in ottone per duplex esterno per art. 328.

Brass adjustable shower holder, for external duplex per art. 328.

CR

**32507**

Supporto per doccetta estraibile per bordo lavello e bordo vasca, modello a base tonda.

Support for extensible handshower for deck bath and deck sink, round base model.

CR

**325S07**

Supporto dritto per doccetta estraibile per bordo lavello e bordo vasca, modello a base quadra.

Straight support for extensible handshower for deck bath and deck sink, squared base model.

CR

LINEA PARRUCCHIERE - HAIRDRESSER LINE



K66
Mixer per acconciatore completo con doccia estraibile.
Barber mixer complete with pull-out shower.

CR



Doccetta per parrucchiere, nera.
Handshower for hairdresser, black.

K66DONE

CR

Senza scatola - *Without box*

K66DONEX

CR

Con scatola - *With box*



K66CO
Miscelatore per parrucchiere.
Single-lever mixer for hairdresser.

CR



K66SU
Supporto per doccetta parrucchiere.
Holder for hairdresser handshower.

CR



K66FLNG
Flessibile in nylon grigio intrecciato M15x1 girevole, 3/8F, cm 120.
Flexible in grey braided nylon for hairdresser handshower M15x1 swiveling, 3/8F, cm 120.

CR



K66FLNY
Flessibile in nylon nero, M15x1 girevole, 3/8F, cm 120.
Flexible hose in black nylon for hairdresser handshower, M15x1 swiveling, 3/8F, cm 120.

CR



K66

BORDO VASCA
DECK BATH MIXERS

DOCCHETTE
HANDSHOWERS

SALISCENDI
SLIDING RAILS

PANNELLI DOCCIA
SHOWER PANELS

BOCCHE
SPOUTS

SOFFIONI
SHOWER HEADS

CROMOTERAPIA
COLORTHERAPY

KIT WELLNESS
WELLNESS KIT

COLONNE DOCCIA
SHOWER COLUMNS

TERMOSTATICI
THERMOSTATICS

A PULSANTE
PUSH-BUTTON

BOX INCASSO
BUILT-IN BOX

FLESSIBILI PER DOCCIA - FLEXIBLE HOSES FOR SHOWER

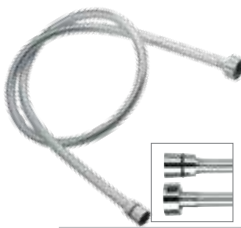

Flessibile doccia in PVC atossico con piattina cromata, attacco conico.
Flexible hose for shower in atoxic PVC and chrome flat wire inside all around, with one conical nut.

332CNBC120 - 120cm	
332CNBC150 - 150cm	
332CNBC200 - 200cm	



Flessibile per doccia retinato metallizzato in PVC atossico, con attacco conico.
Flexible hose for shower with net working metal colour, in atoxic PVC, with one conical nut.

332CNMTR120 - 120cm	
332CNMTR150 - 150cm	
332CNMTR200 - 200cm	



Flessibile per doccia retinato metallizzato in pvc atossico, con attacco doppio brillante conico.
Flexible hose for shower with net working metal colour, in atoxic pvc, with double conical shiny brilliant nut.

332CN2G120 - 120cm	
332CN2G150 - 150cm	
332CN2G200 - 200cm	



Flessibile doccia Spyroflex, bianco-cromo, in pvc atossico, con un attacco conico.
Flexible hose for shower Spyroflex, in atoxic pvc, white-chrome, with one conical nut.

334CNBC120 - 120cm	
334CNBC150 - 150cm	
334CNBC200 - 200cm	



Flessibile "Biflex" per doccia in pvc atossico, con attacco conico, in cromo bianco.
"Biflex" flexible hose in atoxic pvc for shower, with one conical nut, in chrome white.

332CN120 - 120cm	
332CN150 - 150cm	
332CN200 - 200cm	



Flessibile "Biflex" per doccia in pvc atossico, con attacco a doppia ghiera.
"Biflex" flexible hose in atoxic pvc for shower, with double nut connection, in chrome white.

332120 - 120cm	
332150 - 150cm	
332200 - 200cm	



Flessibile "Biflex" per doccia in pvc atossico, con attacco conico, in cromo nero.
"Biflex" flexible hose in atoxic pvc for shower, with one conical nut, in chrome black.

332CNNC120 - 120cm	
332CNNC150 - 150cm	
332CNNC200 - 200cm	



Flessibile per doccia retinato in pvc atossico, con un attacco conico, retinatura bianca.
Flexible hose for shower with net working, in atoxic pvc, with one conical nut, white colour.

332CNREBI120 - 120cm	
332CNREBI150 - 150cm	
332CNREBI200 - 200cm	



Flessibile per doccia Spyroflex nero-cromo in pvc atossico, con un attacco conico.
Flexible hose for shower Spyroflex, black and chrome, in atoxic pvc, with one conical nut.

334CNNC120 - 120cm	
334CNNC150 - 150cm	
334CNNC200 - 200cm	

FLESSIBILI PER DOCCIA ESTRAIBILE - FLEXIBLE HOSES FOR PULL-OUT



Flessibile doccia per estraibile cucina, con interno in gomma epdm alimentare, tracciato in nylon nero, con attacco conico + maschio girevole 15x1.

Flexible shower hose for sinks pull-outs with inside tube in epdm, braided with black nylon, with one conical nut and one swivelling male 15x1.



332NY1512120 - 120cm

332NY1512150 - 150cm

332NY1512200 - 200cm



Flessibile doccia per estraibile cucina, con interno in gomma epdm alimentare, tracciato in nylon grigio, con attacco conico + maschio girevole 15x1.

Flexible shower hose for sinks pull-outs with inside tube in epdm, braided with grey nylon, with one conical nut and one swivelling male 15x1.



332NG1512120 - 120cm

332NG1512150 - 150cm

332NG1512200 - 200cm



Flessibile doccia per estraibile cucina, tracciato in acciaio inox, con interno in gomma epdm alimentare, con attacco conico + maschio girevole 15x1.

Flexible shower hose for sinks pull-outs with inside tube in epdm, braided with stainless steel, with one conical nut and one swivelling male 15x1.



332IN1512120 - 120cm

332IN1512150 - 150cm

332IN1512200 - 200cm



Flessibile doccia per estraibile cucina, con interno in gomma epdm alimentare, trecciato in nylon bianco e acciaio inox, con attacco conico + maschio girevole 15x1.

Flexible shower hose for sinks pull outs with inside tube in epdm, braided with white nylon and stainless steel, with one conical nut and one swivelling male 15x1.



332BX1512120 - 120cm

332BX1512150 - 150cm

332BX1512200 - 200cm

FLESSIBILI IN METALLO - FLEXIBLE METAL HOSES



Flessibile per doccia in acciaio INOX con attacco a doppia ghiera, tubo in EPDM.

Flexible hose for shower, stainless steel with double nut connection, EPDM rubber inside.



333X100 - 100cm

333X120 - 120cm

333X150 - 150cm

333X200 - 200cm



Flessibile per doccia estraibile in acciaio INOX Ø 14, tubo interno in gomma EPDM, attacco conico, 1/2".

Shower flexible hose in stainless steel Ø 14, internal in EPDM rubber, one conical nut, 1/2".



333CNX120 - 120cm

333CNX150 - 150cm

333CNX200 - 200cm



Flessibile per doccia estraibile in ottone Ø 14, M15x1, 1/2" con attacco conico, tubo in EPDM.

Flexible in Brass for pull-out spray shower Ø 14, M15x1, 1/2" with one conical nut, EPDM rubber inside.



333CN1512120 - 120cm

333CN1512150 - 150cm

DOCCETTE - HAND SHOWERS



Flessibile per doccia estensibile a doppia graffatura in ottone, con sistema girevole ed anti-torsione, Ø 15 mm, tubo in EPDM, con attacco conico.

Flexible and extensible hose for shower, in Brass, anti-twist swivelling system, Ø mm 15, EPDM rubber inside, with one conical nut.



Girevole anti-torsione
Anti-twist swivelling

333CNDGAT120 - 120cm	
333CNDGAT150 - 150cm	
333CNDGAT200 - 200cm	



Flessibile per doccia estensibile a doppia graffatura in acciaio INOX Ø 14 F.F., tubo in EPDM, con attacco conico.

Flexible and extensible hose for shower, double clinching in stainless steel, Ø 14 F.F., EPDM rubber internal, with one conical nut.



333CNXES100 - 100cm	
333CNXES120 - 120cm	
333CNXES150 - 150cm	
333CNXES175 - 175cm	
333CNXES200 - 200cm	

FLESSIBILI DOCCIA IN FINITURA - SHOWER FLEXIBLE HOSES WITH FINISHING



Flessibile per doccia estraibile in **acciaio INOX** Ø 14, tubo interno in gomma EPDM, attacco conico, 1/2", nero opaco.

Shower flexible hose in stainless steel Ø 14, internal in EPDM rubber, one conical nut, 1/2", matt black.

333CNX120NO - 120cm	
333CNX150NO - 150cm	



Flessibile per doccia retinato metallizzato in pvc atossico, con attacco doppio brillante conico, nero opaco.

Flexible hose for shower with net working metal colour, in atoxic pvc, with double conical shiny brilliant nut, matt black

332CN2G120NO - 120cm	
332CN2G150NO - 150cm	



Flessibile per doccia retinato metallizzato in pvc atossico, con attacco doppio brillante conico, bianco opaco.

Flexible hose for shower with net working metal colour, in atoxic pvc, with double conical shiny brilliant nut, matt white.

332CN2G120BO - 120cm	
332CN2G150BO - 150cm	



Flessibile per doccia retinato metallizzato in pvc atossico, con attacco doppio brillante conico, nichel spazzolato.

Flexible hose for shower with net working metal colour, in atoxic pvc, with double conical shiny brilliant nut, brushed nickel.

332CN2G120NP - 120cm	
332CN2G150NP - 150cm	



Flessibile per doccia retinato metallizzato in pvc atossico, con attacco doppio brillante conico, visual inox.

Flexible hose for shower with net working metal colour, in atoxic pvc, with double conical shiny brilliant nut, visual steel.

332CN2G120XV - 120cm	
332CN2G150XV - 150cm	



Flessibile per doccia retinato metallizzato in pvc atossico, con attacco doppio brillante conico, cromo nero spazzolato.

Flexible hose for shower with net working metal colour, in atoxic pvc, with double conical shiny brilliant nut, brushed black chrome.

332CN2G120CFP - 120cm	
332CN2G150CFP - 150cm	



Flessibile per doccia retinato metallizzato in pvc atossico, con attacco doppio brillante conico, oro spazzolato.

Flexible hose for shower with net working metal colour, in atoxic pvc, with double conical shiny brilliant nut, brush gold.

332CN2G120BG - 120cm	
-----------------------------	--

332CN2G150BG - 150cm	
-----------------------------	--



Flessibile per doccia retinato metallizzato in pvc atossico, con attacco doppio brillante conico, oro lucido.

Flexible hose for shower with net working metal colour, in atoxic pvc, with double conical shiny brilliant nut, shiny gold.

332CN2G120DO - 120cm	
-----------------------------	--

332CN2G150DO - 150cm	
-----------------------------	--



Flessibile per doccia retinato metallizzato in pvc atossico, con attacco doppio brillante conico, rame spazzolato.

Flexible hose for shower with net working metal colour, in atoxic pvc, with double conical shiny brilliant nut, brushed copper.

332CN2G120RP - 120cm	
-----------------------------	--

332CN2G150RP - 150cm	
-----------------------------	--



Flessibile per doccia retinato metallizzato in pvc atossico, con attacco doppio brillante conico, vecchio rame.

Flexible hose for shower with net working metal colour, in atoxic pvc, with double conical shiny brilliant nut, old copper.

332CN2G120VR - 120cm	
-----------------------------	--

332CN2G150VR - 150cm	
-----------------------------	--



Flessibile per doccia retinato metallizzato in pvc atossico, con attacco doppio brillante conico, vecchio ottone.

Flexible hose for shower with net working metal colour, in atoxic pvc, with double conical shiny brilliant nut, old brass.

332CN2G120VO - 120cm	
-----------------------------	--

332CN2G150VO - 150cm	
-----------------------------	--



Flessibile per doccia retinato metallizzato in pvc atossico, con attacco doppio brillante conico, oil bronze.

Flexible hose for shower with net working metal colour, in atoxic pvc, with double conical shiny brilliant nut, oil bronze.

332CN2G120BR - 120cm	
-----------------------------	--

332CN2G150BR - 150cm	
-----------------------------	--



BORDO VASCA - DECK BATH MIXER

BORDO VASCA DECK BATH MIXER



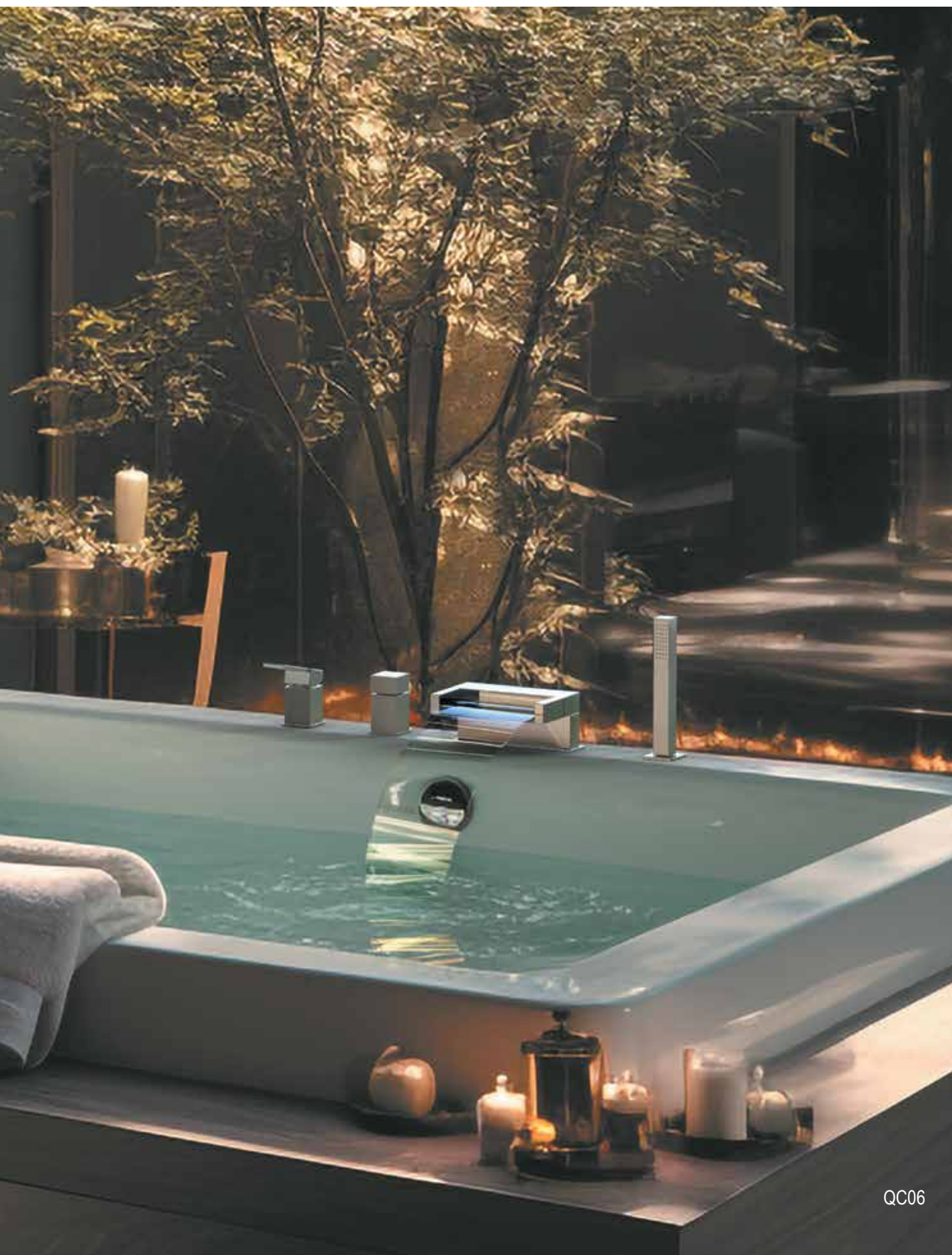

BORDO VASCA
DECK BATH MIXERS

DOCCHETTE
HANDSHOWERS

SALISCENDI
SLIDING RAILS

PANNELLI DOCCIA
SHOWER PANELS

BOCCHE
SPOUTS

SOFFIONI
SHOWER HEADS

CROMOTERAPIA
COLOR THERAPY

KIT WELLNESS
WELLNESS KIT

COLONNE DOCCIA
SHOWER COLUMNS

TERMOSTATICI
THERMOSTATICS

A PULSANTE
PUSH-BUTTON

BOX INCASSO
BUILT-IN BOX



I07

Miscelatore monocomando bordo vasca con deviatore integrato nella bocca e doccetta estraibile in ABS ad 1 funzione anticalcare, flessibile in ottone 150 cm.

Single lever deck bath mixer with lever diverter integrated on the spout, with minimal spout and 1 function ABS antilimestone pull-out handshower, brass flexible hose 150 cm.

CR

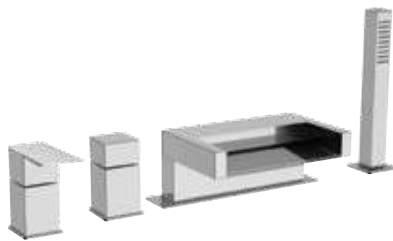

QC06

Miscelatore monocomando bordo vasca con deviatore, doccetta ad 1 funzione in ottone e bocca a cascata, flessibile in ottone 150 cm.

Single-lever deck bath mixer with diverter, 1 function squared brass pull-out handshower and waterfall spout, brass flexible hose 150 cm.

CR



Q06

Miscelatore monocomando bordo vasca con deviatore, doccetta ad 1 funzione in ottone e bocca multigetto, flessibile in ottone 150 cm.

Single-lever deck bath mixer with diverter, 1 function squared brass pull-out handshower and multijet spout, brass flexible hose 150 cm.

CR



I07UF

Miscelatore monocomando bordo vasca con deviatore integrato nel miscelatore, bocca a cascata e doccetta estraibile in ABS ad 1 funzione anticalcare, flessibile in ottone 150 cm.

Single lever deck bath mixer with diverter integrated on the mixer, with waterfall spout and 1 function ABS antilimestone pull-out handshower, brass flexible hose 150 cm.

CR



T07UF

Miscelatore monocomando bordo vasca con deviatore integrato nel miscelatore, bocca pesante fusa con effetto a cascata e doccetta estraibile in ABS anticalcare a 4 funzioni, flessibile ottone 150 cm.

Single lever deck bath mixer with diverter integrated on the mixer, with heavy casted spout waterfall jet, antilimestone pull-out ABS handshower 4 functions, brass flexible hose 150 cm.

CR



N07

Miscelatore monocomando bordo vasca con deviatore integrato nella bocca e doccetta estraibile ad 1 funzione in ottone, flessibile in ottone 150 cm.

Single lever deck bath mixer with lever diverter integrated in the spout, 1 function pull-out brass handshower, brass flexible hose 150 cm.

CR



BOCCHE - SPOUTS



91ZCF
Bocca bordo vasca con effetto multigetto.
Spout for deck bath/shower with multijets effect.

CR



91ZCA
Bocca bordo vasca getto a cascata.
Spout for deck bath/shower with waterfall jet.

CR

FIN 1

FIN 2



91UF07
Bocca bordo vasca con getto a cascata.
Spout for deck bath/shower with waterfall jet.

CR

FIN 1

FIN 2

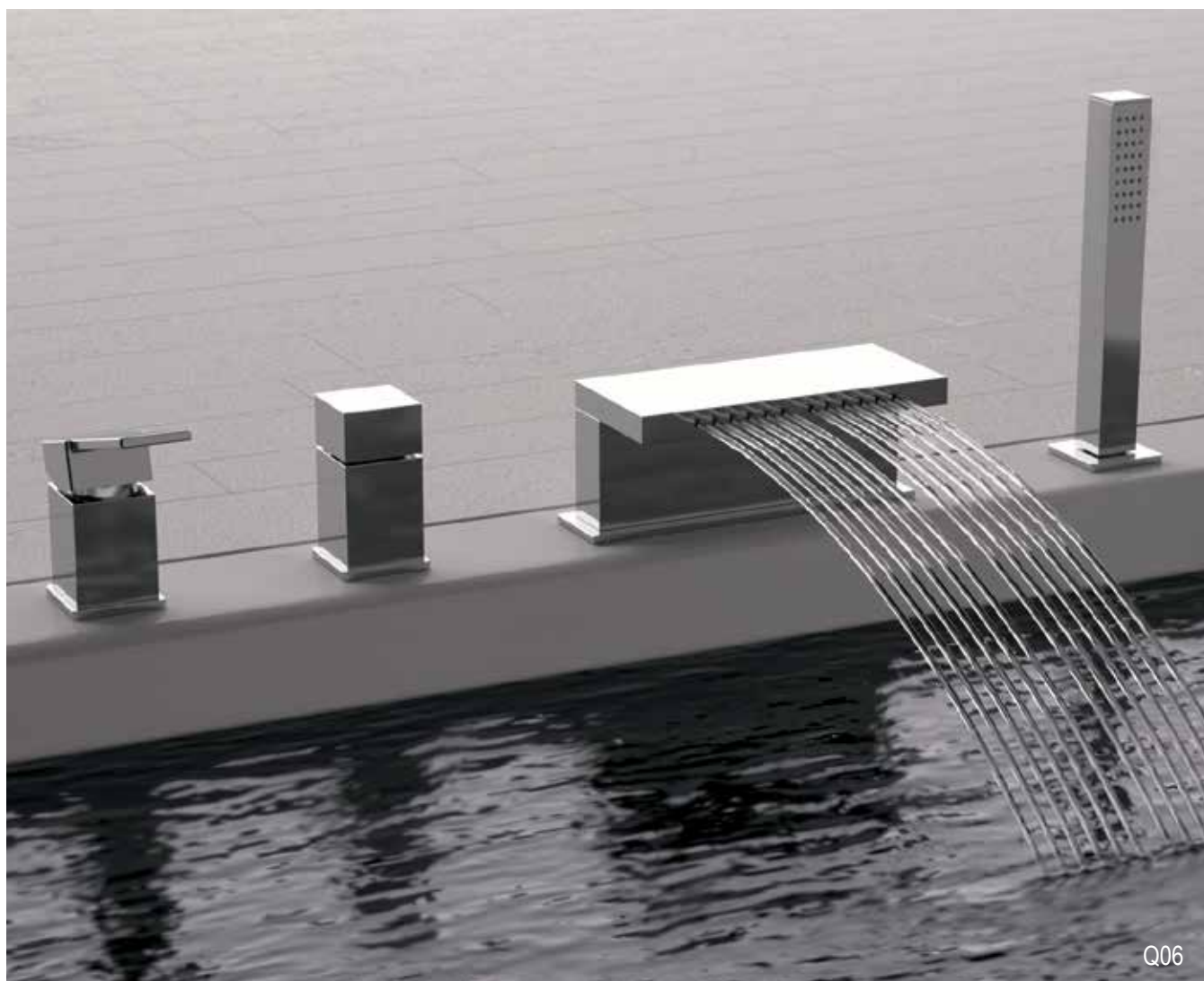

Q06

BOX INCASSO
BUILT-IN BOX
A PULSANTE
PUSH-BUTTON
TERMOSTATICI
THERMOSTATICS
COLONNE DOCCIA
SHOWER COLUMNS
KIT WELLNESS
WELLNESS KIT
CROMOTERAPIA
COLOR THERAPY
SOFFIONI
SHOWER HEADS
BOCCHE
SPOUTS
PANNELLI DOCCIA
SHOWER PANELS
SALISCENDI
SLIDING RAILS
DOCCETTE
HANDSHOWERS
BORDO VASCA
DECK BATH MIXERS





INOX

X STYLE INOX



Nella collezione X-STYLE INOX, il design slanciato e minimale della rubinetteria X-STYLE viene completamente realizzato in acciaio INOX aggiungendo alle sue forme fluide ed essenziali, la bellezza e la resistenza dell'acciaio inossidabile. La serie è dotata di cartuccia a dischi ceramici Ø 25 mm.

With the X-STYLE INOX collection, the minimal and slender design of X-STYLE faucet series is completely made of stainless steel, adding to the fluid and essential shapes the beauty and the strength of this material. The series is equipped with a Ø 25 mm ceramic disc cartridge.

X STYLE INOX

WELLNESS INOX
INOX WELLNESSACCESSORI INOX
INOX ACCESSORIES

OUTDOOR \ INDOOR

CUCINA INOX
INOX KITCHEN

SSX10LXLB

MISCELATORI LAVABO - WASHBASIN MIXERS



SSX10B

Monocomando lavabo, con scarico click-clack con troppo-pieno e senza foro sul corpo.
Single-lever basin mixer, with click-clack waste with overflow and without body hole.

INOX

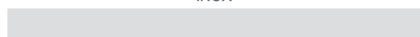

SSX12

Monocomando lavabo, senza scarico e senza foro sul corpo.
Single-lever basin mixer, without waste and without body hole.

INOX

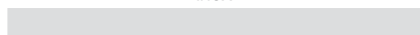

SSX10LXLB

Miscelatore monocomando lavabo alto L, con scarico click-clack con troppo-pieno e senza foro sul corpo.
Single-lever basin mixer L high neck, with click-clack waste with overflow and without body hole.

INOX

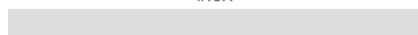

SSX12LXL

Miscelatore monocomando lavabo alto L, senza scarico e senza foro sul corpo.
Single-lever basin mixer L high neck, without waste and without body hole.

INOX

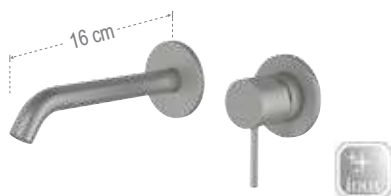
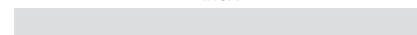

SSX15P

Miscelatore monocomando a incasso per lavabo, in ottone.
Single-lever built-it basin mixer, in chrome plated brass.

INOX

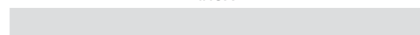

SSX15PL

Miscelatore monocomando a incasso per lavabo, in ottone. Lunghezza bocca 19 cm.
Single-lever built-it basin mixer, in chrome plated brass. Spout length 19 cm.

INOX

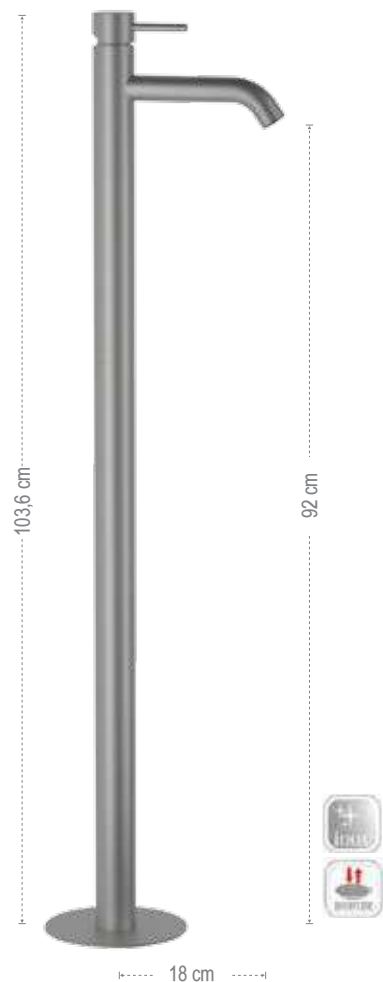
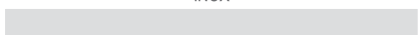

SSX18

Miscelatore monocomando lavabo da pavimento con scarico click-clack e troppo-pieno, articolo completo.
Single-lever mixer floor mounting with click-clack waste with overflow, complete product.

INOX

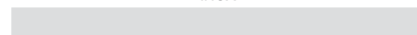

SSX08FIS

Solo parte interna.
Built-in components only.

INOX



SSX18E

Solo parti esterne.
Exposed components only.

INOX

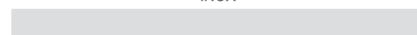

MISCELATORI BIDET - *BIDET MIXERS***SSX57**

Miscelatore monocomando lavabo due fori.
2-holes single-lever washbasin mixer.

INOX

**SSX20B**

Monocomando bidet con scarico click-clack con troppo-pieno.
Single-lever bidet mixer with click-clack waste with overflow.

INOX

**SSX22**

Monocomando bidet senza scarico e senza foro sul corpo.
Single-lever bidet mixer without waste and without body hole.

INOX

MISCELATORI ESTERNI PER VASCA E DOCCIA - *EXPOSED MIXERS FOR BATH AND SHOWER***SSXT02**

Termostatico vasca esterno con kit doccia, flessibile 150 cm e doccetta ad una funzione.
Exposed bath thermostatic with shower kit, flexible 150 cm and one function brass minimal handshower.

INOX

**SSXT39**

Termostatico doccia esterno con kit doccia, flessibile 150 cm e doccetta ad una funzione.
Exposed shower thermostatic with shower kit, flexible 150 cm and one function brass minimal handshower.

INOX

SSXT05

Termostatico vasca esterno senza kit doccia.
Exposed bath thermostatic without shower kit.

INOX

SSXT31

Termostatico doccia esterno senza kit doccia.
Exposed shower thermostatic without shower kit.

INOX

**SS317M317MM**

Saliscendi minimale con doccetta ad 1 funzione tutto in acciaio INOX spazzolato e flessibile in pvc color grigio acciaio 150 cm.
Minimal sliding rail set with 1 function handshower all in brushed stainless steel and 150 cm pvc steel grey colour flexible hose.

INOX

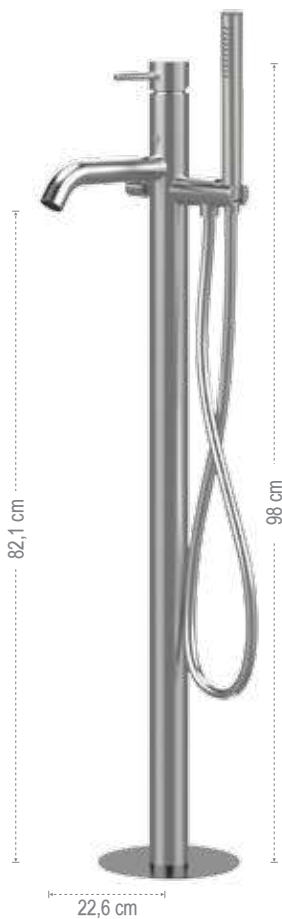

SSX08

Miscelatore vasca da pavimento con deviatore, doccia ad 1 funzione tutto in acciaio INOX spazzolato e flessibile in pvc color grigio acciaio 150 cm. Articolo completo.

Free standing bath mixer floor mounting with diverter, 1 function handshower all in brushed stainless steel and and 150 cm pvc steel grey colour flexible hose. Complete product.

INOX



SSX08FIS

Solo parte interna.
Built-in components only.

INOX



SSX08E

Solo parti esterne.
Exposed components only.

INOX

BOCCHIE - SPOUTS



SS91X

Bocca incasso per miscelatore vasca/doccia in acciaio inox.

Built-in spout for bath/shower mixer in stainless steel.

INOX

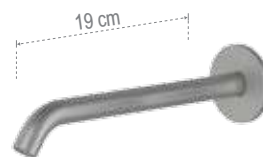

SS91XL

Bocca incasso per miscelatore vasca/doccia in acciaio inox. Lunghezza bocca 19 cm.

Built-in spout for bath/shower mixer in stainless steel. Spout length 19 cm.

INOX

MISCELATORI A INCASSO PER DOCCIA - BUILT-IN MIXERS FOR SHOWER



SSX30L

Miscelatore doccia incasso.
Built-in shower mixer.

INOX



SSX92P

Miscelatore monocomando per doccia con deviatore a 2 posizioni con doppia piastra.

Single-lever shower mixer, with 2 positions diverter on double flange.

INOX



SSX93P

Miscelatore monocomando per doccia con deviatore a 3 vie e 3 posizioni (una entrata e tre uscite) i con doppia piastra.

Single lever built-in shower mixer with 3 ways diverter and 3 positions (1 inlet and 3 outlets) on double flange.

INOX



SSXT09Q

Miscelatore doccia incasso termostatico con deviatore a pulsante su piastra rettangolare.

Thermostatic built-in shower mixer with push-button diverter and rectangular plate.

INOX





SSX08

X STYLE INOX

WELLNESS INOX
INOX WELLNESS

ACCESSORI INOX
INOX ACCESSORIES

OUTDOOR \ INDOOR

CUCINA INOX
INOX KITCHEN

WELLNESS INOX - INOX WELLNESS

WELLNESS INOX



Una selezione completa di articoli dedicati all'interno doccia e di accessori bagno, tutti realizzati in acciaio inossidabile con finitura spazzolata: un materiale pratico, funzionale e resistente, sempre più apprezzato anche per la sua resa estetica nella progettazione di interni dal taglio moderno e minimalista.

A complete selection of items dedicated to shower interiors and bathroom accessories, all made of stainless steel with brushed finish: a practical, functional and resistant material, increasingly appreciated also for its aesthetic performance in the design of interiors with a modern and minimalist cut.



X STYLE INOX

WELLNESS INOX
INOX WELLNESSACCESSORI INOX
INOX ACCESSORIES

OUTDOOR \ INDOOR

CUCINA INOX
INOX KITCHEN

COLONNE DOCCIA - SHOWER COLUMNS



SSX37UFM25

Colonna doccia con miscelatore esterno doccia con deviatore integrato, doccetta ad 1 funzione e soffione Ø25 cm anticalcare.

Shower column with external shower mixer with integrated diverter, 1 function handshower and Ø25 cm shower head.

INOX



SSXT37UFM25

Colonna doccia con miscelatore esterno doccia termostatico con deviatore integrato, doccetta ad 1 funzione e soffione Ø25 cm anticalcare.

Shower column with thermostatic external shower mixer with integrated diverter, 1 function handshower and Ø25 cm shower head.

INOX



WELLNESS



Set doccia composto da: miscelatore a incasso in acciaio inox con deviatore a 2 posizioni, soffione in acciaio inox SS357UFM20X, braccio in acciaio inox 30 cm, saliscendi in acciaio inox spazzolato SS317M, presa acqua a muro, doccetta minimale in acciaio inox, 1 funzione SS317MM, flessibile in PVC 150 cm.

Shower set including: stainless steel built-in mixer with 2-position diverter, stainless steel shower head SS357UFM20X, stainless steel arm 30 cm, brushed stainless steel sliding rail SS317M, wall water connection, 1-function stainless steel hand shower SS317MM, 150 cm PVC flexible hose.



SSX92PS01UFM20

con soffione da cm Ø20 cm e braccio a parete 30 cm.

with shower head cm Ø20 cm and wall arm 30 cm.

INOX

SSX92PS01UFM25

con soffione da cm Ø25 cm e braccio a parete 30 cm.

with shower head cm Ø25 cm and wall arm 30 cm.

INOX

SSX92PS01UFM30

con soffione da cm Ø30 cm e braccio a parete 30 cm.

with shower head cm Ø30 cm and wall arm 30 cm.

INOX

SSX92PS21UFM20

con soffione da cm Ø20 cm e braccio a soffitto da 30 cm.

with shower head cm Ø20 cm and ceiling arm 30 cm.

INOX



Set doccia composto da: miscelatore a incasso in acciaio inox con deviatore a 2 posizioni, soffione in acciaio inox SS357UFM20X, braccio in acciaio inox 30 cm, presa acqua a muro con supporto doccetta, doccetta minimale in acciaio inox, 1 funzione SS317MM, flessibile in PVC 150 cm.

Shower set including: stainless steel built-in mixer with 2-position diverter, stainless steel shower head SS357UFM20X, stainless steel arm 30 cm, wall water connection with shower holder, 1-function stainless steel hand shower SS317MM, 150 cm PVC flexible hose.



SSX92PS02UFM20

con soffione da cm Ø20 cm e braccio a parete 30 cm.

with shower head cm Ø20 cm and wall arm 30 cm.

INOX

SSX92PS02UFM25

con soffione da cm Ø25 cm e braccio a parete 30 cm.

with shower head cm Ø25 cm and wall arm 30 cm.

INOX

SSX92PS02UFM30

con soffione da cm Ø30 cm e braccio a parete 30 cm.

with shower head cm Ø30 cm and wall arm 30 cm.

INOX

SSX92PS22UFM20

con soffione da cm Ø20 cm e braccio a soffitto da 30 cm.

with shower head cm Ø20 cm and ceiling arm 30 cm.

INOX



Set doccia composto da: miscelatore a incasso in acciaio inox con deviatore a 3 vie, soffione in acciaio inox SS357UFM20X, braccio in acciaio inox 30 cm, saliscendi in acciaio inox spazzolato SS317M, presa acqua a muro, doccetta minimale in acciaio inox, 1 funzione SS317MM, 6 getti tondi, flessibile in PVC 150 cm.

Shower set including: stainless steel built-in mixer with 3-way diverter, stainless steel shower head SS357UFM20X, stainless steel arm 30 cm, brushed stainless steel sliding rail SS317M, wall water connection, 1-function stainless steel hand shower SS317MM, 6 round body jets, 150 cm PVC flexible hose.



SSX93PS01UFM20

con soffione da cm Ø20 cm e braccio a parete 30 cm.
with shower head cm Ø20 cm and wall arm 30 cm.

INOX

SSX93PS01UFM25

con soffione da cm Ø25 cm e braccio a parete 30 cm.
with shower head cm Ø25 cm and wall arm 30 cm.

INOX

SSX93PS01UFM30

con soffione da cm Ø30 cm e braccio a parete 30 cm.
with shower head cm Ø30 cm and wall arm 30 cm.

INOX

SSX93PS21UFM20

con soffione da cm Ø20 cm e braccio a soffitto da 30 cm.
with shower head cm Ø20 cm and ceiling arm 30 cm.

INOX



Set doccia composto da: miscelatore a incasso in acciaio inox con deviatore a 3 vie, soffione in acciaio inox SS357UFM20X, braccio in acciaio inox 30 cm, presa acqua a muro con supporto doccetta, doccetta minimale in acciaio inox, 1 funzione SS317MM, 6 getti tondi, flessibile in PVC 150 cm.

Shower set including: stainless steel built-in mixer with 3-way diverter, stainless steel shower head SS357UFM20X, stainless steel arm 30 cm, wall water connection with shower holder, 1-function stainless steel hand shower SS317MM, 6 round body jets, 150 cm PVC flexible hose.



SSX93PS02UFM20

con soffione da cm Ø20 cm e braccio a parete 30 cm.
with shower head cm Ø20 cm and wall arm 30 cm.

INOX

SSX93PS02UFM25

con soffione da cm Ø25 cm e braccio a parete 30 cm.
with shower head cm Ø25 cm and wall arm 30 cm.

INOX

SSX93PS02UFM30

con soffione da cm Ø30 cm e braccio a parete 30 cm.
with shower head cm Ø30 cm and wall arm 30 cm.

INOX

SSX93PS22UFM20

con soffione da cm Ø20 cm e braccio a soffitto da 30 cm.
with shower head cm Ø20 cm and ceiling arm 30 cm.

INOX



SSX93PS01MMCA

Set doccia composto da: miscelatore a incasso in acciaio inox con deviatore a 3 vie, soffione a parete in acciaio inox con getto a pioggia e cascata SS350MMCA, saliscendi in acciaio inox spazzolato SS317M, presa acqua a muro, doccetta minimale in acciaio inox, 1 funzione SS317MM, flessibile in PVC 150 cm.

Shower set including: stainless steel built-in mixer with 3-way diverter, wall mounted stainless steel shower head with rain and waterfall functions SS350MMCA, brushed stainless steel sliding rail SS317M, wall water connection, 1-function stainless steel hand shower SS317MM, 150 cm PVC flexible hose.

INOX



SSX93PS02MMCA

Set doccia composto da: miscelatore a incasso in acciaio inox con deviatore a 3 vie, soffione a parete in acciaio inox con getto a pioggia e cascata SS350MMCA, presa acqua a muro con supporto doccetta, doccetta minimale in acciaio inox, 1 funzione SS317MM, flessibile in PVC 150 cm.

Shower set including: stainless steel built-in mixer with 3-way diverter, wall mounted stainless steel shower head with rain and waterfall functions SS350MMCA, wall water connection with shower holder, 1-function stainless steel hand shower SS317MM, 150 cm PVC flexible hose.

INOX



KIT SENZA MISCELATORE ACCIAIO INOX SPAZZOLATO
KIT WITHOUT BRUSHED STAINLESS STEEL SHOWER MIXER



Set doccia composto da: soffione in acciaio inox SS357UFM20X, braccio in acciaio inox 30 cm, presa acqua a muro con supporto doccetta, doccetta minimale in acciaio inox, 1 funzione SS317MM, flessibile in PVC 150 cm.

Shower set including: stainless steel shower head SS357UFM20X, stainless steel arm 30 cm, wall water connection with shower holder, 1-function stainless steel hand shower SS317MM, 150 cm PVC flexible hose.



SSSETS02UFM20

con soffione da cm Ø20 cm e braccio a parete 30 cm.
 with shower head cm Ø20 cm and wall arm 30 cm.

INOX

SSSETS02UFM25

con soffione da cm Ø25 cm e braccio a parete 30 cm.
 with shower head cm Ø25 cm and wall arm 30 cm.

INOX

SSSETS02UFM30

con soffione da cm Ø30 cm e braccio a parete 30 cm.
 with shower head cm Ø30 cm and wall arm 30 cm.

INOX



Set doccia composto da: soffione in acciaio inox SS357UFS20X, braccio in acciaio inox 30 cm, presa acqua a muro con supporto doccetta, doccetta piatta in acciaio inox a 1 funzione SS317RR, flessibile in PVC 150 cm.

Shower set including: stainless steel shower head SS357UFS20X, stainless steel arm 30 cm, wall water connection with shower holder, 1-function stainless steel flat hand shower SS317RR, 150 cm PVC flexible hose.



SSSETS027RRUFS20

con soffione da cm 20x20 cm e braccio a parete 30 cm.
 with shower head cm 20x20 cm and wall arm 30 cm.

INOX

SSSETS027RRUFS25

con soffione da cm 25x25 cm e braccio a parete 30 cm.
 with shower head cm 25x25 cm and wall arm 30 cm.

INOX

SSSETS027RRUFS30

con soffione da cm 30x30 cm e braccio a parete 30 cm.
 with shower head cm 30x30 cm and wall arm 30 cm.

INOX

SALISCENDI CON DOCCIA - SLIDING RAILS WITH HANDSHOWER



SS317M317MM

Saliscendi minimale con doccetta ad 1 funzione tutto in acciaio INOX spazzolato. Flessibile 150 cm. Altezza 60 cm.

Minimal sliding rail set with 1 function handshower all in brushed stainless steel. Flexible hose 150 cm. Height 60 cm.

INOX



SS317M332

Saliscendi in acciaio INOX spazzolato con asta tonda e centralina in acciaio INOX con flessibile in pvc 150 cm senza doccetta, in scatola con finestra.

Brushed stainless steel sliding rail set and stainless steel sliding shower holder, with pvc flexible hose 150 cm without handshower, in box.

INOX



IDROSCOPINI - HYDRO-BRUSH

**SSRB150S01**

Set wc in acciaio inox 316L, idroscopino con flessibile 120cm, attacco G1/2".
Stainless steel 316L wc set, hydro-brush with cm 120 flexible hose, G1"1/2 connection.

INOX

**SSRB150**

Doccetta idroscopino in acciaio inox 316L anticalcare.
Hydro-brush wc handspray, stainless steel 316L, anti limestone.

INOX

SHUT-OFF

**SS338M3320N**

Set doccetta igienica in acciaio inox con flessibile 120cm, attacco G1/2".
Stainless steel shut-off handshower with cm 120 flexible hose, G1"1/2 connection.

INOX

**SSX60P**

Set doccetta igienica in acciaio inox con flessibile 120cm, attacco G1/2", incasso con miscelazione, cartuccia Ø25.
Stainless steel shut-off set with handshower, cm 120 flexible hose, G1"1/2 connection, Ø25 cartridge built-in shut-off mixer.

INOX

**SS3320N**

Doccetta igienica shut-off inox 316L anticalcare.
Stainless steel 316L anti limestone shut-off handshower.

INOX

KIT SUPPORTO CON PRESA ACQUA E DOCCETTA HANDSHOWER AND WATER PUNCH WITH SHOWER HOLDER KIT

**SS337M317MM**

Set doccia minimale in acciaio INOX spazzolato composto da: presa acqua con supporto lusso, doccetta ad 1 funzione e flessibile in pvc color grigio acciaio 150 cm.

Minimal brushed stainless steel shower set composed of: water punch shower holder, and 1 function handshower and 150 cm pvc steel grey colour flexible hose.

INOX

SOFFIONI A SOFFITTO CON TELAIO - CEILING SHOWER HEADS WITH FIXING SET



SS357SFS43

Soffione a soffitto in Acciaio INOX spazzolato, getti anticalcare, 43x43 cm con getto a pioggia.
Ceiling brushed stainless steel shower head , antilimestone jets, 43x43 cm, with rain jet.

INOX

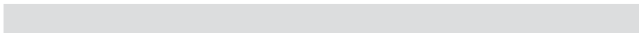

SS357SFS50

Soffione a soffitto in Acciaio INOX spazzolato, getti anticalcare, 50x50 cm con getto a pioggia.
Ceiling brushed stainless steel shower head, antilimestone jets, 50x50 cm, with rain jet.

INOX

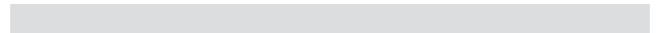

SS357SFS43C

Soffione a soffitto in Acciaio INOX spazzolato, getti anticalcare, 43x43 cm, a 2 funzioni: pioggia e cascata.
Ceiling brushed stainless steel shower head, antilimestone jets, 43x43 cm, 2 functions: rain and waterfall.

INOX

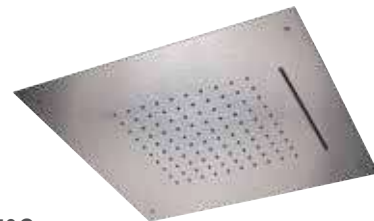
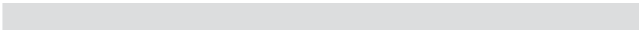

SS357SFS50C

Soffione a soffitto in Acciaio INOX spazzolato, getti anticalcare, 50x50 cm, a 2 funzioni: pioggia e cascata.
Ceiling brushed stainless steel shower head, antilimestone jets, 50x50 cm, 2 functions: rain and waterfall.

INOX



SS357SFS43NC

Soffione a soffitto in Acciaio INOX spazzolato, getti anticalcare, 43x43 cm, a 3 funzioni: pioggia, nebulizzazione (4 uscite) ed 1 getto a cascata.
Ceiling brushed stainless steel shower head, antilimestone jets, 43x43 cm, 3 functions: rain jet, nebulization (4 outlet) and waterfall.

INOX

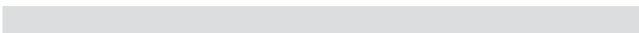

SS357SFS50NC

Soffione a soffitto in Acciaio INOX spazzolato, getti anticalcare, 50x50 cm, a 3 funzioni: pioggia, nebulizzazione (4 uscite) ed 1 getto a cascata.
Ceiling brushed stainless steel shower head , antilimestone jets, 50x50 cm, 3 functions: rain, nebulization (4 outlet) and waterfall.

INOX

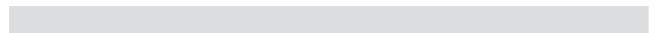

SOFFIONI A SOFFITTO "EASY FIX" - CEILING SHOWER HEADS "EASY FIX"

**SS357EFM34**

Soffione doccia EASY FIX in acciaio INOX spazzolato Ø34 cm. Con getti anticalcare.

EASY FIX brushed stainless steel shower head Ø34 cm. With antilimestone jets.

INOX

**SS357EFM44**

Soffione doccia EASY FIX in acciaio INOX spazzolato Ø44 cm. Con getti anticalcare.

EASY FIX brushed stainless steel shower head Ø44 cm. With antilimestone jets.

INOX

**SS357EFS34**

Soffione doccia EASY FIX in acciaio INOX spazzolato 34x34 cm. Con getti anticalcare.

EASY FIX brushed stainless steel shower head 34x34 cm. With antilimestone jets.

INOX

**SS357EFS44**

Soffione doccia EASY FIX in acciaio INOX spazzolato 44x44 cm. Con getti anticalcare.

EASY FIX brushed stainless steel shower head 44x44 cm. With antilimestone jets.

INOX

APPLICAZIONE A SOFFITTO "EASY FIX" - "EASY FIX" CEILING APPLICATION

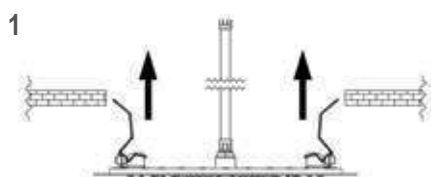

Per questa tipologia di soffione e con questo specifico sistema di fissaggio sono previste quattro molle per ogni soffione.

Nell'immagine 1 si evidenzia il primo movimento necessario: caricare due molle vicine tra loro mettendole quasi in posizione verticale rispetto al soffione ed inserirle all'interno del foro precedentemente preparato. Rilasciare le stesse delicatamente.

For this specic shower-head with this specific mounting system, four springs are installed on each head.

In picture 1, you shall see the first needed movement to activate them:

Spring-load two springs next to each other placing them almost vertically and insert them in the hole in the ceiling;

Release them gently;

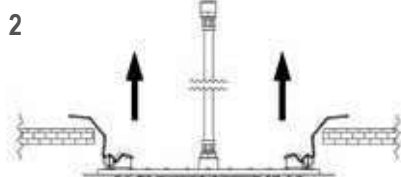

Mantenendo il soffione leggermente inclinato procedere caricando ed inserendo le rimanenti due molle come da immagine 2.

While keeping the shower head slightly inclined, proceed by spring-loading and inserting the two other springs as shown in picture 2.



A questo punto rilasciare delicatamente le molle alla loro naturale tensione e, trattenendo esternamente il soffione, accompagnare lo stesso verso il totale appoggio al soffitto come da immagine 3.

Now release the springs back to their natural tension and, while holding the head from outside, guide it to its final position as shown in picture 3.

SOFFIONI A PARETE - WALL MOUNTED SHOWER HEADS



SS350SSX

Soffione doccia anticalcare a parete 50x20 cm, in acciaio INOX spazzolato.
Brushed stainless steel wall shower head antilimestone 50x20 cm.

INOX



SS350SSCAX

Soffione doccia anticalcare a parete 50x20 cm, in acciaio INOX spazzolato, 2 funzioni: getto a pioggia e cascata.
Brushed stainless steel wall shower head antilimestone, 2 functions: rain and waterfall, 50x20 cm.

INOX



SS350UFX

Soffione doccia anticalcare ultrapiatto 50x25 cm, a parete in acciaio INOX spazzolato.
Ultraslim antilimestone brushed stainless steel wall shower head 50x25 cm.

INOX

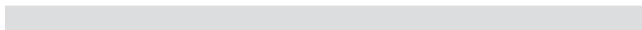

SS350UFCAX

Soffione doccia anticalcare ultrapiatto 50x25 cm, a parete in acciaio INOX spazzolato, 2 funzioni: getto a pioggia e cascata.
Ultraslim antilimestone brushed stainless steel wall shower head, 2 functions: rain and waterfall, 50x25 cm.

INOX

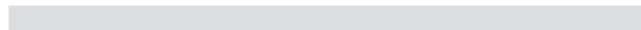

SS350MMCAX

Soffione doccia 50x20 cm, a parete in acciaio INOX spazzolato, 2 funzioni: a pioggia e cascata.
Brushed stainless steel wall shower head, 2 functions: rain jet and waterfall, 50x20 cm.

INOX

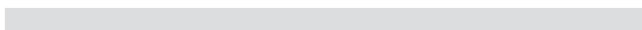

SS350MMX

Soffione doccia 50x20 cm, a parete in acciaio INOX spazzolato, a pioggia.
Brushed stainless steel wall shower head, 2 functions: rain jet, 50x20 cm.

INOX

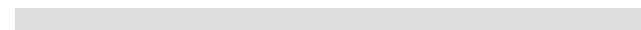

CROMOTERAPIA - CHROMOTHERAPY



IN DOTAZIONE AI MODELLI
SUPPLIED THE MODEL

Pulsantiera a parete per accensione luce bianca, selezione colori e cromoterapia automatica.
Wall push-button to turn, on, select the colors and change of the jet.



IN DOTAZIONE AI MODELLI CON CODICE "W"
SUPPLIED THE MODEL WITH "W" CODE

Pulsantiera wireless per accensione luce bianca, selezione colori e cromoterapia automatica.
Wireless push-button to turn, on, select the colors and change of the jet.

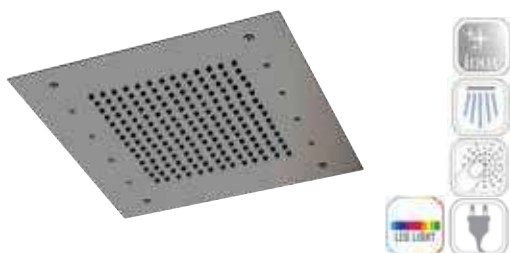

Soffione a soffitto in Acciaio INOX spazzolato 43x43 cm, getto a pioggia anticalcare. Luce LED a 7 colori con 40 sfumature, alimentazione dalla rete elettrica con trasformatore a basso voltaggio incluso (12V). Pulsantiera a parete inclusa.

Ceiling brushed stainless steel shower head 43x43 cm, with antilimestone rain jet. 7 colors light led with 40 shades. Powered by electricity with low voltage transformer included (12V). Wall push-button included.

SS357RS43

INOX

SS357RS43W

con pulsantiera
with remote control



INOX

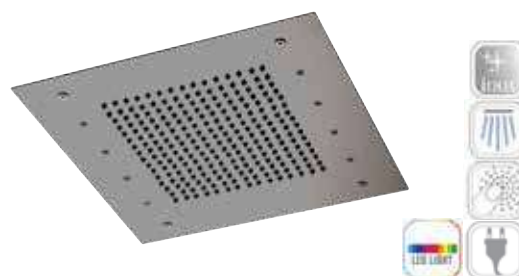

Soffione a soffitto in Acciaio INOX spazzolato 50x50 cm, getto a pioggia anticalcare. Luce LED a 7 colori con 40 sfumature, alimentazione dalla rete elettrica con trasformatore a basso voltaggio incluso (12V). Pulsantiera a parete inclusa.

Ceiling brushed stainless steel shower head 50x50 cm, with antilimestone rain jet. 7 colors light led with 40 shades. Powered by electricity with low voltage transformer included (12V). Wall push-button included.

SS357RS50

INOX

SS357RS50W

con pulsantiera
with remote control



INOX

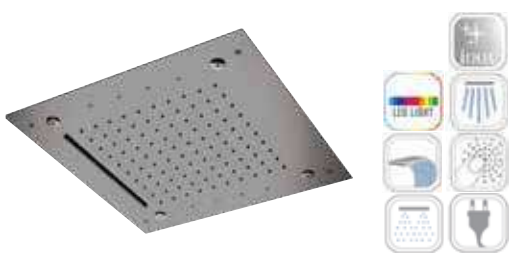

Soffione a soffitto in Acciaio INOX spazzolato 43x43 cm, con 3 funzioni: getto a pioggia anticalcare, nebulizzazione (4 uscite) e getto a cascata. Luce LED a 7 colori con 40 sfumature, alimentazione dalla rete elettrica con trasformatore a basso voltaggio incluso (12V). Pulsantiera a parete inclusa.

Ceiling brushed stainless steel shower head 43x43 cm, with 3 functions: antilimestone rain jet, nebulization (4 outlets) and 1 waterfall jet. 7 colors light led with 40 shades. Powered by electricity with low voltage transformer included (12V). Wall push-button included.

SS357RS43NC

INOX

SS357RS43NCW

con pulsantiera
with remote control



INOX

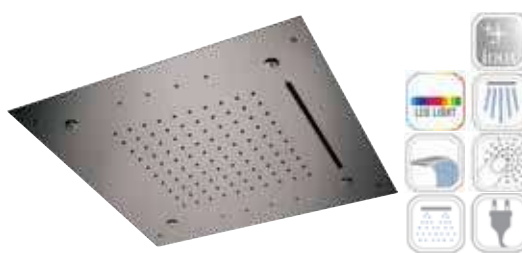

Soffione a soffitto in Acciaio INOX spazzolato 50x50 cm, con 3 funzioni: getto a pioggia anticalcare, nebulizzazione (4 uscite) e getto a cascata. Luce LED a 7 colori con 40 sfumature, alimentazione dalla rete elettrica con trasformatore a basso voltaggio incluso (12V). Pulsantiera a parete inclusa.

Ceiling brushed stainless steel shower head 50x50 cm, with 3 functions: antilimestone rain jet, nebulization (4 outlets) and 1 waterfall jet. 7 colors light led with 40 shades. Powered by electricity with low voltage transformer included (12V). Wall push-button included.

SS357RS50NC

INOX

SS357RS50NCW

con pulsantiera
with remote control



INOX

SOFFIONI E GETTI - SHOWER HEADS & BODY JETS



Soffione doccia tondo ultrapiatto in acciaio INOX spazzolato.
Ultraslim round brushed stainless steel shower head.

SS357UFM20X	Ø20 cm	INOX
SS357UFM25X	Ø25 cm	INOX
SS357UFM30X	Ø30 cm	INOX
SS357UFM40X	Ø40 cm	INOX



Soffione doccia quadrato ultrapiatto in acciaio INOX spazzolato.
Ultraslim squared brushed stainless steel shower head.

SS357UFS20X	20x20 cm	INOX
SS357UFS25X	25x25 cm	INOX
SS357UFS30X	30x30 cm	INOX
SS357UFS40X	40x40 cm	INOX



SSNX34JET

Getto rotondo Ø 5 cm, in acciaio INOX spazzolato per sistema doccia, anticalcare, con snodo.
Round body jet Ø 5 cm, in brushed stainless steel for shower systems, antilimestone, with ball-joint.

INOX



SSQX34JET

Getto quadrato 5x5 cm, in acciaio INOX spazzolato per sistema doccia, anticalcare, con snodo.
Squared body jet 5x5 cm, in brushed stainless steel for shower systems, antilimestone, with ball-joint.

INOX



SS 357UFM25X

DOCCETTE - HANDSHOWERS



18,5 cm

SS317MMX

Doccetta minimale ad una funzione in acciaio INOX spazzolato. In scatola.

Minimal one function handshower, in brushed stainless steel. In box

INOX



21 cm

SS317RRX

Doccetta rettangolare minimale ultrapiatta, in acciaio INOX spazzolato ad 1 funzione. In scatola.

Extraflat rectangular handshower, in brushed stainless steel, 1 function. In box

INOX



BRACCI DOCCIA - SHOWER ARMS



Braccio doccia tondo da soffitto, in acciaio INOX spazzolato.

Ceiling round shower arm, in brushed stainless steel.

SS347N10 10 cm

SS347N20 20 cm

SS347N30 30 cm

**SS343L30**

Braccio doccia tondo da parete, in acciaio INOX spazzolato, cm 30.

Wall round shower arm, in brushed stainless steel, cm 30.

INOX



PRESE ACQUA E SUPPORTI - WATER PUNCHES & SHOWER HOLDER

**SS337M**

Supporto lusso con presa acqua minimale in acciaio INOX spazzolato per incasso, per flessibile con attacco conico.

Minimal brushed stainless steel shower holder water punch, for built-in and for conical nut flexible.

INOX

**SS339SOM**

Supporto fisso minimale in acciaio INOX spazzolato per flessibile con attacco conico.

Minimal shower holder brushed stainless steel, for conical nut flexible.

INOX

**SS309**

Attacco presa acqua da 1/2 minimale in acciaio INOX.

Stainless steel wall connector, minimal type 1/2 for shower.

INOX

**SS905CCR114**

Scarico automatico universale in acciaio inox con chiusura click-clack da 1"1/4.

Universal automatic stainless steel pop-up waste with 1"1/4 click-clack system.

INOX

**SS958L**

Sifone "minimal" in acciaio inox per lavabo, 1"1/4, canotto cm 30 e rosone pesante.

Stainless steel "minimal" p trap for wash-basin, 1"1/4, outlet tube cm 30 and heavy flange.

INOX

**SS332CN150**

Flessibile per doccia retinato metallizzato in pvc atossico, con attacco doppio brillante conico, colore acciaio.

Flexible hose for shower with net working metal colour, in atoxic pvc, with double conical shiny brilliant nut, steel color.

INOX



ACCESSORI INOX - INOX ACCESSORIES

ACCESSORI INOX INOX ACCESSORIES



Una collezione completa di accessori per il bagno realizzati in acciaio inossidabile con finitura spazzolata. Una soluzione perfetta per l'arredo bagno in abbinamento alla rubinetteria X-STYLE INOX e alle proposte WELLNESS INOX.

A complete collection of bathroom accessories made of stainless steel with brushed finish. A perfect solution to complete bathroom interiors in combination with X-STYLE INOX faucets and WELLNESS INOX kits.



X STYLE INOX

WELLNESS INOX
INOX WELLNESSACCESSORI INOX
INOX ACCESSORIES

OUTDOOR \ INDOOR

CUCINA INOX
INOX KITCHEN

ACCESSORI - ACCESSORIES



SSXI13A
Dispenser in acciaio INOX spazzolato.
Brushed stainless steel dispenser.

INOX



SSXI13
Dispenser per sapone liquido da parete con supporto tutto in acciaio INOX spazzolato.
Wall mounted soap dispenser with support all in brushed stainless steel.

INOX



SSXI15A
Bicchieri in acciaio INOX spazzolato.
Brushed stainless steel cup.

INOX



SSXI15
Portabicchiere da parete con bicchiere in acciaio INOX spazzolato.
Wall mounted cup holder with glass all in brushed stainless steel.

INOX



SSXI30
Portasalviette in acciaio INOX spazzolato, lunghezza cm 60.
Brushed stainless steel towel holder, length cm 60.

INOX



SSXI40L30
Portasalviette in acciaio INOX spazzolato, lunghezza cm 30.
Brushed stainless steel towel holder, length cm 30.

INOX



SSXI50
Appendino in acciaio INOX spazzolato.
Brushed stainless steel hook.

INOX



SSXI61
Portarotolo in acciaio INOX spazzolato.
Brushed stainless steel toilet paper holder.

INOX

**SSXI62**

Portarotolo di ricambio in acciaio INOX spazzolato.

Brushed stainless steel spare toilet paper holder.

INOX

**SSXI66A**

Portascopino in acciaio INOX spazzolato da pavimento.

Brushed stainless steel floor broom rack holder.

INOX

**SSXI66**

Portascopino in acciaio INOX da parete spazzolato.

Wall brushed stainless steel broom rack holder.

INOX

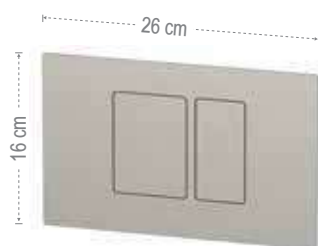
**SSRB820**

Piastra WC con pulsanti rettangolari.

Toilet flush plate with rectangular buttons.

INOX

**SSRB810**

Piastra WC con pulsanti tondi.

Toilet flush plate with rounded buttons.

INOX

**SSRB902**

Lavabo da appoggio rotondo, con ceramica bianca e fascia in acciaio inox spazzolato.

Round countertop washbasin with white ceramic and brushed stainless steel band.

INOX

COMPATIBILITÀ CON : - COMPATIBILITY WITH :

Geberit	Tece
SIGMA 8 CM	2003-2020
SIGMA 12 CM	2021-NOW
Viega	Oil
3H - 3L - 3F	74 PLUS
	120 PLUS
	EXPERT PLUS
	QUADRA PLUS

OUTDOOR / INDOOR

OUTDOOR / INDOOR



Disponibili in diverse finiture e altezze, le nostre colonne doccia offrono soluzioni pratiche e raffinate per ogni spazio esterno. Sia che tu voglia un momento di relax dopo un bagno di sole o una comoda doccia post-sportiva, le nostre colonne sono l'ideale per un tocco di freschezza e comfort all'aperto.

Scegli la tua colonna doccia outdoor e trasforma il tuo spazio esterno in un'oasi di benessere.

Available in various finishes and heights, our outdoor shower columns provide practical and refined solutions for any outdoor space. Whether you want a moment of relaxation after sunbathing or a convenient shower after sports, our columns are ideal for adding a touch of freshness and comfort outdoors.

Choose your outdoor shower column and transform your outdoor space into a wellness oasis.



X STYLE INOX

WELLNESS INOX
INOX WELLNESSACCESSORI INOX
INOX ACCESSORIES

OUTDOOR \ INDOOR

CUCINA INOX
INOX KITCHEN

SS331Q2L7MMUJFM20

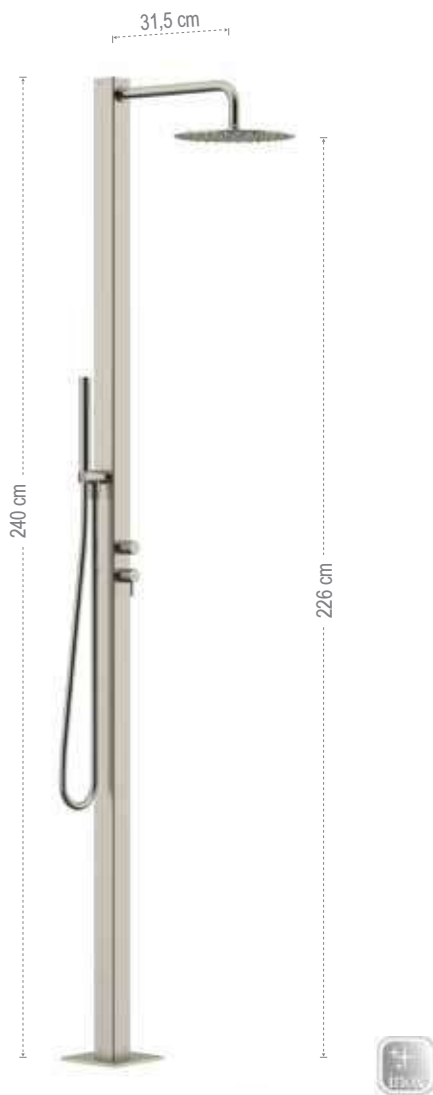

Colonna doccia da esterno in acciaio inox spazzolato, miscelatore monocomando a 2 vie con soffione tondo a pioggia anti-calcare e doccetta, acqua calda-fredda con attacco da pavimento.

Outdoor shower column in brushed stainless steel, 2-way single lever mixer with anti-limestone round rain shower head and hand shower, hot-cold water with floor connection.

SS331Q2L7MMUFM20

Con soffione doccia Ø20cm
With shower head Ø20cm

INOX

SS331Q2L7MMUFM25

Con soffione doccia Ø25cm
With shower head Ø25cm

INOX

SS331Q2L7MMUFM30

Con soffione doccia Ø30cm
With shower head Ø30cm

INOX



COLONNE DOCCIA FREESTANDING - COLONNE DOCCIA PER PISCINA
 FREESTANDING SHOWER COLUMNS - SWIMMING POOL SHOWER COLUMNS

X STYLE INOX

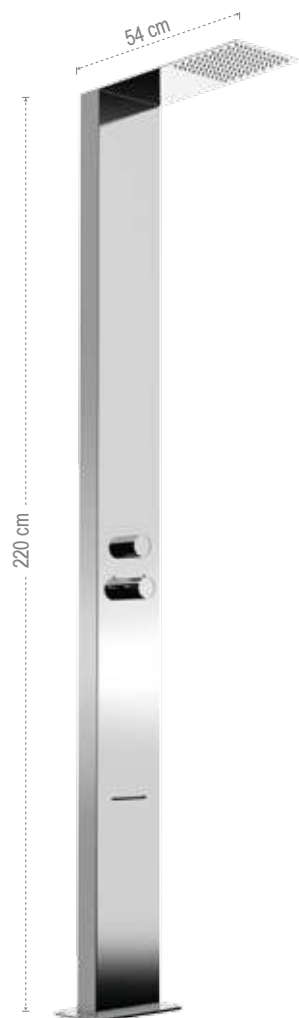
**331SS**

Colonna doccia da esterno in acciaio INOX a 2 vie con getto pioggia anticalcare e getto cascata, acqua calda-fredda con attacco da pavimento.

Stainless steel shower column from outside, 2 ways diverter rain jet with antilimescale and waterfall jet, mixer hot/cold water control for shower, floor water connection.

INOX

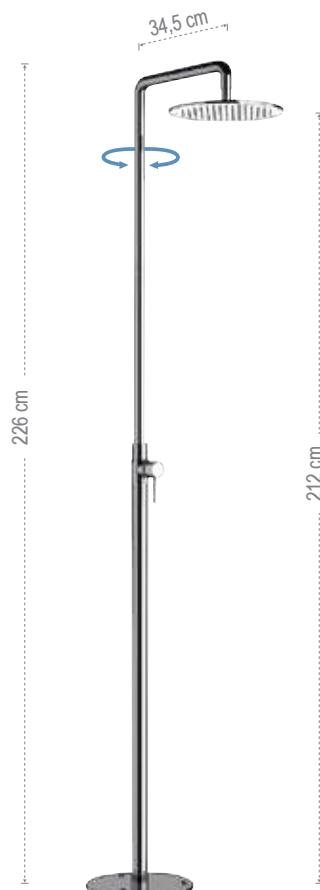
**331N52**

Colonna doccia girevole free-standing con miscelatore acqua calda-fredda, attacco da pavimento con soffione anticalcare Ø 30 cm. Tutta in ottone.

Free-standing swivle shower column with shower mixer hot/cold water control, floor water connection, antilimescale shower head Ø 30 cm. All in brass.

INOX

WELLNESS INOX
INOX WELLNESSACCESSORI INOX
INOX ACCESSORIES

OUTDOOR \ INDOOR

CUCINA INOX
INOX KITCHEN

CUCINA INOX - INOX KITCHEN

CUCINA INOX INOX KITCHEN



Miscelatori per cucina in acciaio inossidabile: una soluzione per il lavello pratica, igienica e funzionale, estremamente resistente sia al tempo che all'usura. La scelta tra diversi modelli permette di soddisfare le necessità progettuali in cucine di ogni grandezza; la cura nel design, nella finitura e nei dettagli estetici rende il prodotto un elemento di eleganza anche nelle cucine a vista.

Stainless steel kitchen mixer faucets: a practical, hygienic and functional solution for sink, extremely resistant to both time and deterioration. The choice between different models allows to satisfy the design needs in kitchens of all sizes; the attention to design, finish and aesthetic details makes the product an element of elegance even in open kitchens.

X STYLE INOX

WELLNESS INOX
INOX WELLNESSACCESSORI INOX
INOX ACCESSORIES

OUTDOOR \ INDOOR

CUCINA INOX
INOX KITCHEN

SSX72



23.2 cm

22 cm

49 cm

SSX543
Miscelatore monocomando per lavello in acciaio inox 316L, bocca con flessibile a molla, doccetta orientabile a due getti, anticalcare.
Single-lever sink mixer in 316L stainless steel, spout with spring hose, two-jet adjustable hand shower, anti-limescale.

INOX

**SSX541**

Miscelatore monocomando per lavello in acciaio inox 316L, bocca con flessibile rivestito in gomma soft-touch nero opaco, doccetta orientabile a due getti, anticalcare.

Single-lever sink mixer in 316L stainless steel, spout with flexible hose covered in matt black soft-touch rubber, two-jet adjustable hand shower, anti-limescale.

INOX



SSX72

Miscelatore monocomando per lavello, con bocca girevole, areatore anticalcare M22x1, acciaio inox spazzolato 316L.
Single-lever sink mixer, with swivel spout, M22x1 anti-limescale aerator, brushed stainless steel 316L.

INOX



SSX72C

Miscelatore monocomando per lavello, con bocca girevole, areatore anticalcare M22x1, acciaio inox spazzolato 316L. Modello corto.
Single-lever sink mixer, with swivel spout, M22x1 anti-limescale aerator, brushed stainless steel 316L. Short spout.

INOX



SSX72U

Miscelatore monocomando per lavello in acciaio inox 316L spazzolato, canna quadra a "U" girevole.
Single-lever sink mixer in brushed 316L stainless steel, square "U" swivel spout.

INOX



SSX84DJ

Miscelatore monocomando per lavello in acciaio inox 316L, con doccia estraibile a due getti, anticalcare.
Single-lever sink mixer in 316L stainless steel, with two-jet pull-out hand shower, anti-limescale.

INOX



SSX84DJ

X STYLE INOX

WELLNESS INOX
INOX WELLNESS

ACCESSORI INOX
INOX ACCESSORIES

OUTDOOR \ INDOOR

CUCINA INOX
INOX KITCHEN





ARREDARE LA CUCINA
FURNISH THE KITCHEN

ELEGANT KITCHEN

ELEGANT KITCHEN



Una selezione di miscelatori per lavello dal design moderno e innovativo, studiata per arricchire con personalità ed eleganza la vostra cucina. Tutti gli articoli sono dotati del comfort di una pratica doccetta estraibile.

A selection of sink mixers with a modern and innovative design, designed to enrich your kitchen with elegance and personality. All items are equipped with the comfort of a handy pull-out shower.



ELEGANT KITCHEN

CUCINA ESTRAIBILI
PULL-OUTTUTTO CUCINA
ALL KITCHENCUCINA COUNTRY
COUNTRY KITCHENACQUA DEPURATA
PURIFIED WATER

TOUCH-ME

ELEGANT KITCHEN

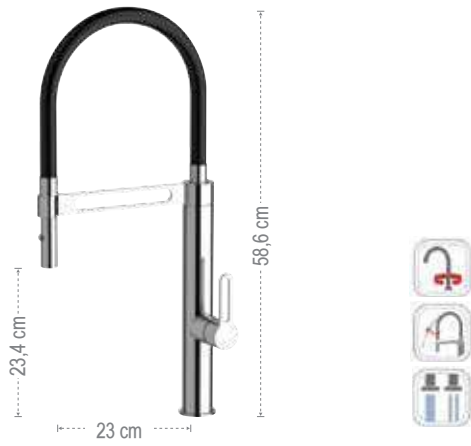

SR511

Miscelatore lavello con flessibile rivestito in tubo gomma soft-touch nero opaco.
Sink mixer with flexible hose coated in soft-touch matt black rubber pipe.

CR

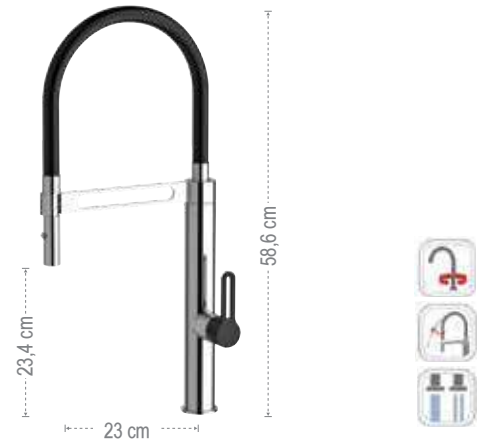

SR512

Miscelatore lavello con flessibile rivestito in tubo gomma soft-touch nero opaco, maniglia verniciata nera opaca.
Sink mixer with flexible hose coated in soft-touch matt black rubber pipe, matt black painted handle.

CR





SR541

Miscelatore lavello con flessibile rivestito in tubo gomma soft-touch nero opaco.
Sink mixer with flexible hose coated in soft-touch matt black rubber pipe.

CR



SR542

Miscelatore lavello con flessibile rivestito in tubo gomma soft-touch nero opaco, maniglia verniciata nera opaca.
Sink mixer with flexible hose coated in soft-touch matt black rubber pipe, matt black painted handle.

CR



SR545

Miscelatore lavello con flessibile rivestito in tubo gomma soft-touch bianco opaco.
Sink mixer with flexible hose coated in soft-touch matt white rubber pipe.

CR



SR546

Miscelatore lavello con flessibile rivestito in tubo gomma soft-touch bianco opaco, maniglia verniciata bianca opaca.
Sink mixer with flexible hose coated in soft-touch matt white rubber pipe, matt white painted handle.

CR



SR543

Miscelatore lavello con flessibile nero rivestito con molla "fine design".
Sink mixer with black flexible hose coated with "fine design" spring.

CR



SR544

Miscelatore lavello con flessibile bianco rivestito con molla "fine design".
Sink mixer with white flexible hose coated with "fine design" spring.

CR



EY77E

Miscelatore monocomando livello a molla con doccetta estraibile dal supporto ed orientabile a due funzioni.

Spring single-lever sink mixer with detachable and adjustable 2-functions handshower.

CR

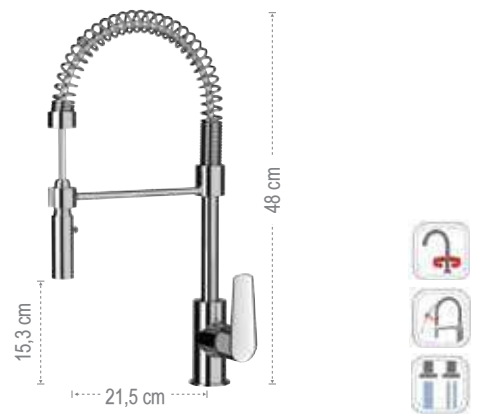

V77E

Miscelatore monocomando livello serie Vanity a molla con doccetta estraibile dal supporto ed orientabile a due funzioni e cartuccia Ø 35.

Spring single-lever sink mixer Vanity series with detachable and adjustable 2 functions handshower and Ø 35 mm cartridge.

CR

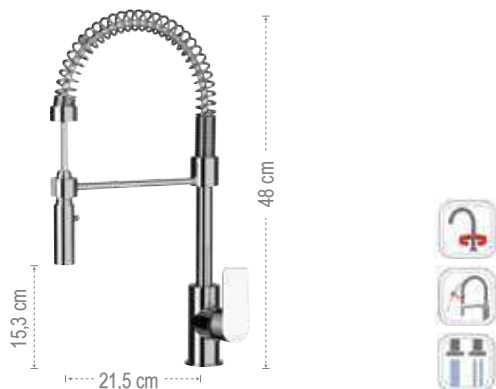

I77E

Miscelatore monocomando livello serie Infinity a molla con doccetta estraibile dal supporto ed orientabile a due funzioni e cartuccia Ø 35.

Spring single-lever sink mixer Infinity series with detachable and adjustable 2 functions handshower and Ø 35 mm cartridge.

CR



L77E

Miscelatore monocomando livello serie Class Line a molla con doccetta estraibile dal supporto ed orientabile a due funzioni e cartuccia Ø 35.

Spring single-lever sink mixer Class Line series with detachable and adjustable 2 functions handshower and Ø 35 mm cartridge.

CR

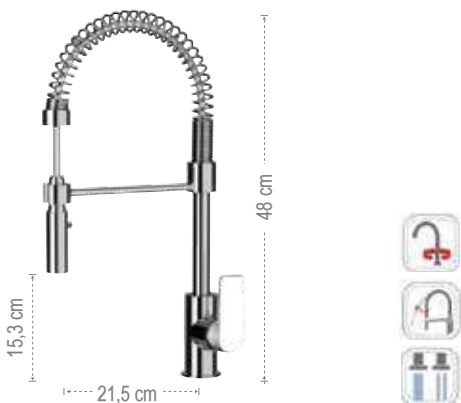

D77E

Miscelatore monocomando livello serie Dream a molla con doccetta estraibile dal supporto ed orientabile a due funzioni e cartuccia Ø 35.

Spring single-lever sink mixer Dream series with detachable and adjustable 2 functions handshower and Ø 35 mm cartridge.

CR

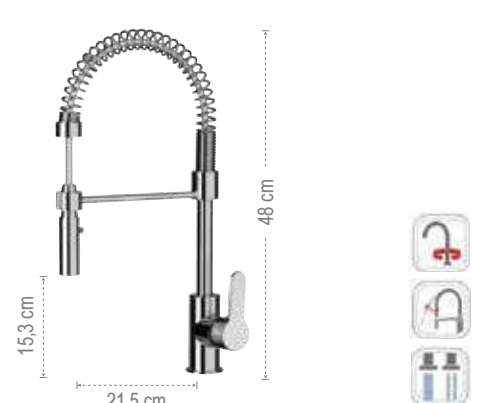

W77E

Miscelatore monocomando livello serie Winner a molla con doccetta estraibile dal supporto ed orientabile a due funzioni e cartuccia Ø 35.

Spring single-lever sink mixer Winner series with detachable and adjustable 2 functions handshower and Ø 35 mm cartridge.

CR



EY77E

ELEGANT KITCHEN

CUCINA ESTRAIBILI
PULL-OUT

TUTTO CUCINA
ALL KITCHEN

CUCINA COUNTRY
COUNTRY KITCHEN

ACQUA DEPURATA
PURIFIED WATER

TOUCH-ME

CUCINA ESTRAIBILE - PULL-OUT

CUCINA ESTRAIBILE PULL-OUT



Le proposte di miscelatori monocomando e tradizionali per lavello inserite nella sezione TUTTO CUCINA di Remer Rubinetterie giocano sulla varietà di stili e di forme per assicurare la massima praticità di utilizzo e per inserirsi con naturalezza in ogni interno cucina, sia moderno che classico.

The proposals for single-lever and traditional sink mixers included in the ALL KITCHEN section by Remer Rubinetterie play on the variety of styles and shapes to ensure maximum practicality of use and to naturally fit into any kitchen interior, both modern and classic.



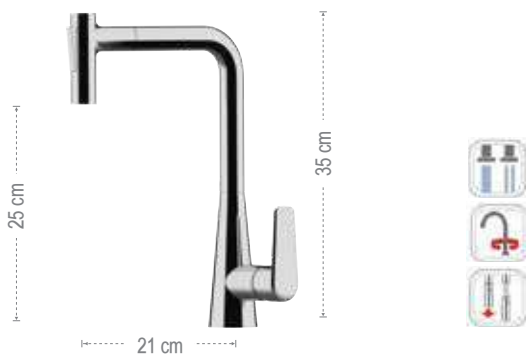

V81M

Miscelatore monocomando per lavello, con canna alta girevole e doccetta estraibile con impugnatura a martello a due funzioni.
Single-lever sink mixer with high swivel spout and 2-functions pull-out "hammer shaped" handle hand shower.

CR



L81M

Miscelatore monocomando per lavello, con canna alta girevole e doccetta estraibile con impugnatura a martello a due funzioni.
Single-lever sink mixer with high swivel spout and 2-functions pull-out "hammer shaped" handle hand shower.

CR



V84DJ



V84

Miscelatore monocomando per lavello, con canna alta girevole e sistema di doccetta monofunzione estraibile.
Single-lever sink mixer with high swivel spout and single-function system pull-out hand shower.

CR

FIN 1

FIN 2



V84DJ

Miscelatore monocomando per lavello, con canna alta girevole e doccetta estraibile a due funzioni.
Single-lever sink mixer with high swivel spout and 2-functions pull-out hand shower.

CR



L84



L84

Miscelatore monocomando per lavello, con canna alta girevole e sistema di doccetta monofunzione estraibile.
Single-lever sink mixer with high swivel spout and single-function system pull-out hand shower.

CR

FIN 1

FIN 2

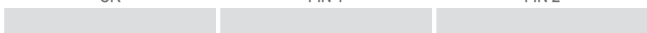

EY84

Miscelatore monocomando per lavello, con canna alta girevole e sistema di doccetta monofunzione estraibile.
Single-lever sink mixer with high swivel spout and single-function system pull-out hand shower.

CR

FIN 1

FIN 2

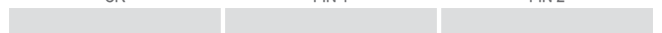



L84DJ



L84DJ

Miscelatore monocomando per lavello, con canna alta girevole e doccetta estraibile a due funzioni.

Single-lever sink mixer with high swivel spout and 2-functions pull-out hand shower.

CR



EY84DJ

Miscelatore monocomando per lavello, con canna alta girevole e doccetta estraibile a due funzioni.

Single-lever sink mixer with high swivel spout and 2-functions pull-out hand shower.

CR

CUCINA ESTRAIBILE - PULL-OUT



K472

Miscelatore monocomando per lavello con doccetta estraibile a getto variabile 2 funzioni.
Single-lever one-hole sink mixer with pull-out spray 2 functions jet hand shower.

CR

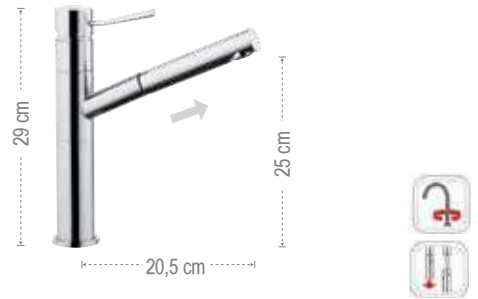

N47

Miscelatore monocomando per lavello con doccetta estraibile.
Single-lever one-hole sink mixer with pull-out hand shower.

CR



U472

Monocomando lavello con bocca alta girevole e doccetta estraibile.
Single lever kitchen mixer with high swivel spout, with pull out spray.

CR



SC47

Monocomando lavello con bocca alta girevole e doccetta estraibile.
Single lever kitchen mixer with high swivel spout, with pull out spray.

CR



N47

ELEGANT KITCHEN

CUCINA ESTRAIBILI
PULL-OUT

TUTTO CUCINA
ALL KITCHEN

CUCINA COUNTRY
COUNTRY KITCHEN

ACQUA DEPURATA
PURIFIED WATER

TOUCH-ME

TUTTO CUCINA - ALL KITCHEN

TUTTO CUCINA ALL KITCHEN



Le proposte di miscelatori monocomando e tradizionali per lavello inserite nella sezione TUTTO CUCINA di Remer Rubinetterie giocano sulla varietà di stili e di forme per assicurare la massima praticità di utilizzo e per inserirsi con naturalezza in ogni interno cucina, sia moderno che classico.

The proposals for single-lever and traditional sink mixers included in the ALL KITCHEN section by Remer Rubinetterie play on the variety of styles and shapes to ensure maximum practicality of use and to naturally fit into any kitchen interior, both modern and classic.



ELEGANT KITCHEN

CUCINA ESTRAIBILI
PULL-OUTTUTTO CUCINA
ALL KITCHENCUCINA COUNTRY
COUNTRY KITCHENACQUA DEPURATA
PURIFIED WATER

TOUCH-ME



V74
 Miscelatore monocomando per lavello, con canna alta a C girevole.
 Single-lever sink mixer with high swivel "C" spout.

CR

FIN 1

FIN 2

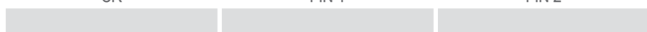

V74U
 Miscelatore monocomando per lavello, con canna alta a U girevole.
 Single-lever sink mixer with high swivel "U" spout.

CR

FIN 1

FIN 2

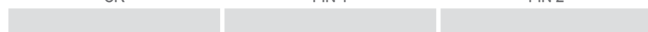

V74NO



I72Q

Miscelatore monocomando per lavello, con bocca alta girevole a "U".
Single lever kitchen mixer with high swivel spout.

CR

Q42U

Miscelatore monocomando per lavello, con bocca alta girevole a "U".
Single lever kitchen mixer with high swivel spout.

CR



I72Q



W72
Miscelatore monocomando monoforo 90°, con canna alta a "C", girevole e leva laterale.
Single-lever sink mixer 90°, high "C" spout, swivel and side lever.



L72
Miscelatore monocomando monoforo 90°, con canna a "C", girevole e leva laterale.
Single-lever sink mixer 90°, high "C" spout, swivel and side lever.

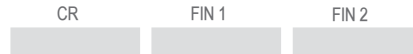

D72
Miscelatore monocomando monoforo 90°, con canna alta a "C", girevole e leva laterale.
Single-lever sink mixer 90°, high "C" spout, swivel and side lever.



I72
Miscelatore monocomando monoforo 90°, con canna alta a "U", girevole e leva laterale.
Single-lever sink mixer 90°, high "U" spout, swivel and side lever.



W72U
Miscelatore monocomando monoforo 90° con canna alta quadra a "U" girevole e leva laterale.
Single-lever one-hole sink mixer, 90° with high swivel "U" spout and side lever.



L72U
Miscelatore monocomando monoforo 90°, serie Class line con canna alta quadra a "U" girevole e leva laterale.
Single-lever one-hole sink mixer, 90°, Class line series with high swivel "U" spout and side lever.



D72U
Miscelatore monocomando monoforo 90°, serie Dream con canna alta quadra a "U" girevole e leva laterale.
Single-lever one-hole sink mixer, 90°, Dream series with high swivel "U" spout and side lever.

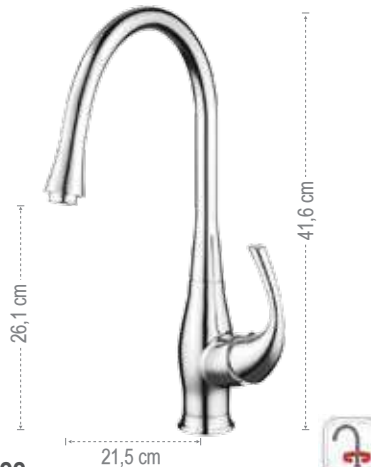

U422
Monocomando lavello con bocca alta girevole.
Single lever kitchen mixer with high swivel spout.





W42B

Miscelatore monocomando per lavello, con bocca alta girevole.
Single-lever one-hole sink mixer, with high swivel spout.

CR



L42B

Miscelatore monocomando per lavello, con bocca alta girevole.
Single-lever one-hole sink mixer, with high swivel spout.

CR



D42B

Miscelatore monocomando per lavello, con bocca alta girevole.
Single-lever one-hole sink mixer, with high swivel spout.

CR



I42B

Miscelatore monocomando per lavello, con bocca alta girevole.
Single-lever one-hole sink mixer, with high swivel spout.

CR



W42BC

Miscelatore monocomando per lavello, con bocca corta girevole.
Single-lever one-hole sink mixer, with short swivel spout.

CR



L42BC

Miscelatore monocomando per lavello, con bocca corta girevole.
Single-lever one-hole sink mixer, with short swivel spout.

CR



D42BC

Miscelatore monocomando per lavello, con bocca corta girevole.
Single-lever one-hole sink mixer, with short swivel spout.

CR



I42BC

Miscelatore monocomando per lavello, con bocca corta girevole.
Single-lever one-hole sink mixer, with short swivel spout.

CR

INSTALLAZIONE A PARETE - WALL MOUNTED



K412
Miscelatore monocomando a muro per lavello con bocca girevole.
Wall mounted single-lever sink mixer with swivel spout.
CR



K45
Miscelatore per lavello a muro con leva lunga.
Wall mounted single-lever sink mixer with long lever.
CR

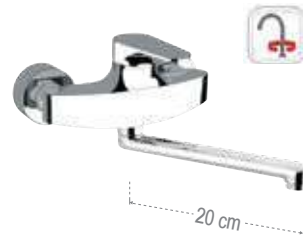

L41
Miscelatore monocomando a muro per lavello con bocca girevole.
Wall mounted single-lever sink mixer with swivel spout.
CR



W41
Miscelatore monocomando a muro per lavello con bocca girevole.
Wall mounted single-lever sink mixer with swivel spout.
CR

BOCCA ALTA - HIGH SPOUT



K422
Miscelatore monocomando per lavello con bocca alta girevole.
Wall mounted single-lever sink mixer with long lever.
CR



R42
Miscelatore monocomando per lavello con bocca alta girevole.
Wall mounted single-lever sink mixer with long lever.
CR



L42
Miscelatore monocomando per lavello con bocca alta girevole.
Wall mounted single-lever sink mixer with long lever.
CR



W42
Miscelatore monocomando per lavello con bocca alta girevole.
Wall mounted single-lever sink mixer with long lever.
CR

BOCCA BASSA - LOW SPOUT



K402
Miscelatore monocomando per lavello con bocca girevole.
Single-lever one-hole sink mixer with swivel spout.
CR



K44
Miscelatore lavello con bocca girevole e con leva lunga.
Sink mixer with swivel spout and long lever.
CR



L40
Miscelatore monocomando per lavello con bocca girevole.
Single lever one-hole sink mixer with swivel spout.
CR



R40
Miscelatore monocomando per lavello con bocca girevole.
Single lever one-hole sink mixer with swivel spout.
CR

SOTTOFINESTRA - UNDER WINDOW



K422R

Miscelatore monocomando monoforo 90° per lavello, con bocca alta girevole ed abbattibile, tipo lusso, modello sottofinestra.
Single-lever one-hole sink mixer, with high swivel and foldable spout, luxury type, under window type.

CR



R42R

Miscelatore monocomando monoforo 90° per lavello, con bocca alta girevole ed abbattibile, tipo lusso, modello sottofinestra.
Single-lever one-hole sink mixer, with high swivel and foldable spout, luxury type, under window type.

CR



L42R

Miscelatore monocomando monoforo 90° per lavello, con bocca alta girevole ed abbattibile, tipo lusso, modello sottofinestra.
Single-lever one-hole sink mixer, with high swivel and foldable spout, luxury type, under window type.

CR



I42R

Miscelatore monocomando monoforo 90° per lavello, con bocca alta girevole ed abbattibile, tipo lusso, modello sottofinestra.
Single-lever one-hole sink mixer, with high swivel and foldable spout, luxury type, under window type.

CR

BORDO LAVELLO - DECK SINK MIXERS



N48332EU

Miscelatore monocomando bordo lavello con deviatore, bocca minimale e doccetta a pulsante minimale in Abs cromata con impugnatura liscia 1/2".
Single lever deck sink mixer with diverter, with C.p. Abs minimal shut-off, with plain handgrip 1/2"

CR



N48319MO

Miscelatore monocomando bordo lavello serie Minimal con deviatore a leva integrato nella bocca minimale e doccetta estraibile cromata minimale a 4 funzioni con getti in silicone ed anticalcare.
Single lever deck sink mixer serie Minimal ever diverter integrated on the spout, with pull-out C.p. minimal handshower 4 functions, anti-limestone with silicone jets.

CR

ELEGANT KITCHEN

CUCINA ESTRAIBILI
PULL-OUT

TUTTO CUCINA
ALL KITCHEN

CUCINA COUNTRY
COUNTRY KITCHEN

ACQUA DEPURATA
PURIFIED WATER

TOUCH-ME

CUCINA COUNTRY - COUNTRY KITCHEN

CUCINA COUNTRY COUNTRY KITCHEN



I rubinetti per cucina COUNTRY sono soluzioni bicomando dal design vintage, per tutti gli interni dal marcato stile classico o antico. Disponibili con speciali colori di finitura.

COUNTRY kitchen taps are dual-control solutions with a vintage design, for all interiors with a marked classic or antique style. Available with special finishing colors.



Miscelatore tradizionale bicomando monoforo per lavello con canna antica. One hole dual control sink mixer with "Antique" spout.

ART. **43LIA** **43LIACE**

VITONE TRADIZIONALE
TRADITIONAL HEAD VALVE

VITONE CERAMICO
CERAMIC HEAD VALVE





Gruppo lavello a muro bicomando con canna superiore antica. Altezza 22 cm, interasse 23 cm. Dual control sink mixer, wall mounted, with swivel high antique spout. Height 22 cm, Interaxis 23 cm.

ART. **41LIA** **41LIACE**

VITONE TRADIZIONALE
TRADITIONAL HEAD VALVE

VITONE CERAMICO
CERAMIC HEAD VALVE

FIN

FINITURA FINISHING	VITONE TRADIZIONALE TRADITIONAL HEAD VALVE	VITONE CERAMICO CERAMIC HEAD VALVE
 VECCHIO OTTONE - OLD BRASS	VO	CE VO
 OTTONE S. MARCO - S. MARCO BRASS	SM	CE SM
 V. OTTONE OPACO - MATT OLD BRASS	OM	CE OM
 VECCHIO RAME - OLD COPPER	VR	CE VR
 OIL BRONZE - OIL BRONZE	BR	CE BR

43LIAVR

ACQUA DEPURATA - PURIFIED WATER

ACQUA DEPURATA PURIFIED WATER



I miscelatori a 3 vie per acqua depurata permettono di gestire direttamente dal rubinetto della cucina anche l'erogazione dell'acqua proveniente da un depuratore. Due percorsi e due aree di uscita indipendenti preservano la qualità ed il sapore dell'acqua depurata, evitando qualsiasi contatto con l'acqua corrente. L'apertura, la chiusura e la regolazione della temperatura per l'acqua corrente avviene sempre tramite la leva di miscelazione, come nell'uso tradizionale.

The 3-way mixers for purified water allow you to manage the supply of water from a purifier directly from the kitchen tap. Two paths and two independent exit areas preserve the quality and flavor of the purified water, avoiding any contact with running water. The opening, closing and temperature setting for running water are always allowed with the mixing lever, as in traditional use.



ELEGANT KITCHEN

CUCINA ESTRAIBILI
PULL-OUTTUTTO CUCINA
ALL KITCHENCUCINA COUNTRY
COUNTRY KITCHENACQUA DEPURATA
PURIFIED WATER

TOUCH-ME

W79DW

KIT ACQUA DEPURATA

Erogare l'acqua potabile filtrata direttamente dal rubinetto della cucina riduce drasticamente il consumo di bottiglie di plastica, i costi di trasporto e le conseguenti emissioni di Co2. Grazie alla collaborazione con BWT, nascono i KIT ACQUA DEPURATA: un'alternativa completa, sostenibile ed ecologica all'acqua in bottiglia.

Il miscelatore a 3 vie permette di accedere da un unico rubinetto sia all'acqua corrente che all'acqua depurata, mantenendo le due erogazioni separate per una totale sicurezza.

Il filtro BWT installato sotto il lavello rimuove dall'acqua corrente solidi e particelle sospese nonché odori e sapori indesiderati, per un'acqua buona, sana e a km zero.

I KIT ACQUA DEPURATA includono:

PURIFIED WATER KIT

Filtered drinking water directly from the kitchen tap drastically reduces the consumption of plastic bottles, transport costs and the resulting CO2 emissions. Thanks to the collaboration with BWT, the PURIFIED WATER KITS are available: a complete, sustainable and ecological alternative to bottled water. The 3-way mixer allows access to both running water and purified water from a single tap, keeping the two outlets separated for total safety. The BWT filter installed under the sink removes solids and suspended particles from running water as well as unwanted smell and taste, for good, healthy and zero km water.

The PURIFIED WATER KITS include:



1

MISCELATORE A 3-VIE PER LAVELLO

Miscelatore a 3-vie per lavello con leva di miscelazione per acqua corrente calda/fredda e selettore laterale per acqua depurata. Percorsi di erogazione separati, aeratori separati. Bocca girevole. Raccordi di collegamento inclusi.

3-WAY MIXER FOR SINK

3-way sink mixer with mixing lever for hot / cold running water and side selector for purified water. Separate dispensing paths, separate aerators. Swivel mouth. Connection fittings included.

2

MONITOR

Il monitor viene installato sotto il lavello e permette di verificare in ogni momento lo stato del filtro. Consiste in un'unità di conteggio programmabile e collegata al filtro tramite un sensore di flusso per indicarne la capacità in tempo reale. Il monitor avvisa tramite un segnale acustico, quando il filtro è in esaurimento e quando è necessario sostituirlo.

MONITOR

The monitor is installed under the sink and allows you to check the status of the filter at any time. It consists of a programmable counting unit connected to the filter via a flow sensor to indicate filter capacity in real time. The monitor also alerts you with an audible signal when the filter is low and when it needs to be replaced.

3

FILTRO

Cartuccia filtrante BWT Bewapur HQ. Cartuccia a struttura composita in grado di trattenere impurità fino a 0,5 micron e rimuovere dall'acqua odori, sapori, colorazioni e corpi estranei non graditi. Il filtro viene installato direttamente sotto il lavandino, collegato sia alla rete idrica che al miscelatore. Capacità del filtro a 12° dH 6000 l.

FILTER

BWT filter cartridge with BWT Bewapur HQ drink filter. Composite structure cartridge to retain impurities up to 0.5 microns and remove unwanted smells, flavours, colours and foreign bodies from the water. The filter is installed under the sink, connected to both the water supply outlet and the mixer. Filter capacity at 12° dH 6000 l.

4

TESTATA PORTA FILTRO

FILTER HOLDER

Caratteristiche tecniche:

Technical features:

Tipo di filtro - <i>Filter type</i>	Bewapur HQ S / Item code A890
Autonomia del filtro - <i>Filter life</i>	6000 litri - liter *
Finezza di filtrazione media - <i>Average filtration finenes</i>	0,5 micron
Portata nominale del filtro max. - <i>Max. nominal flow rate of the filter</i>	3,3 l/min
Dimensioni filtro + testata di connessione - <i>Filter size + connection head (H x D)</i>	270 x 100 mm

	FILTRI - FILTERS	RUBINETTO - TAP
Pressione di esercizio - <i>Operating pressure</i>	2 - 7 bar **	1 - 5 bar **
Temperatura consigliata ingresso acqua calda - <i>Recommended hot water inlet temperature</i>	-	60°C
Temperatura dell'acqua min. / max. - <i>Water temperature min. / max.</i>	4 - 30°C	4 - 80°C
Temperatura ambiente min. / max. - <i>Room temperature min. / max.</i>	4 - 40°C	4 - 40°C

* L'autonomia del filtro può variare in funzione della qualità dell'acqua di alimento. Sostituire il filtro al raggiungimento dell'autonomia o al massimo dopo un anno.
The autonomy of the filter may vary depending on the quality of incoming water. Replace the filter upon reaching autonomy or at the latest after one year.

** Per pressioni superiori prevedere l'utilizzo di un riduttore di pressione.
For higher pressures, use a pressure reducer.

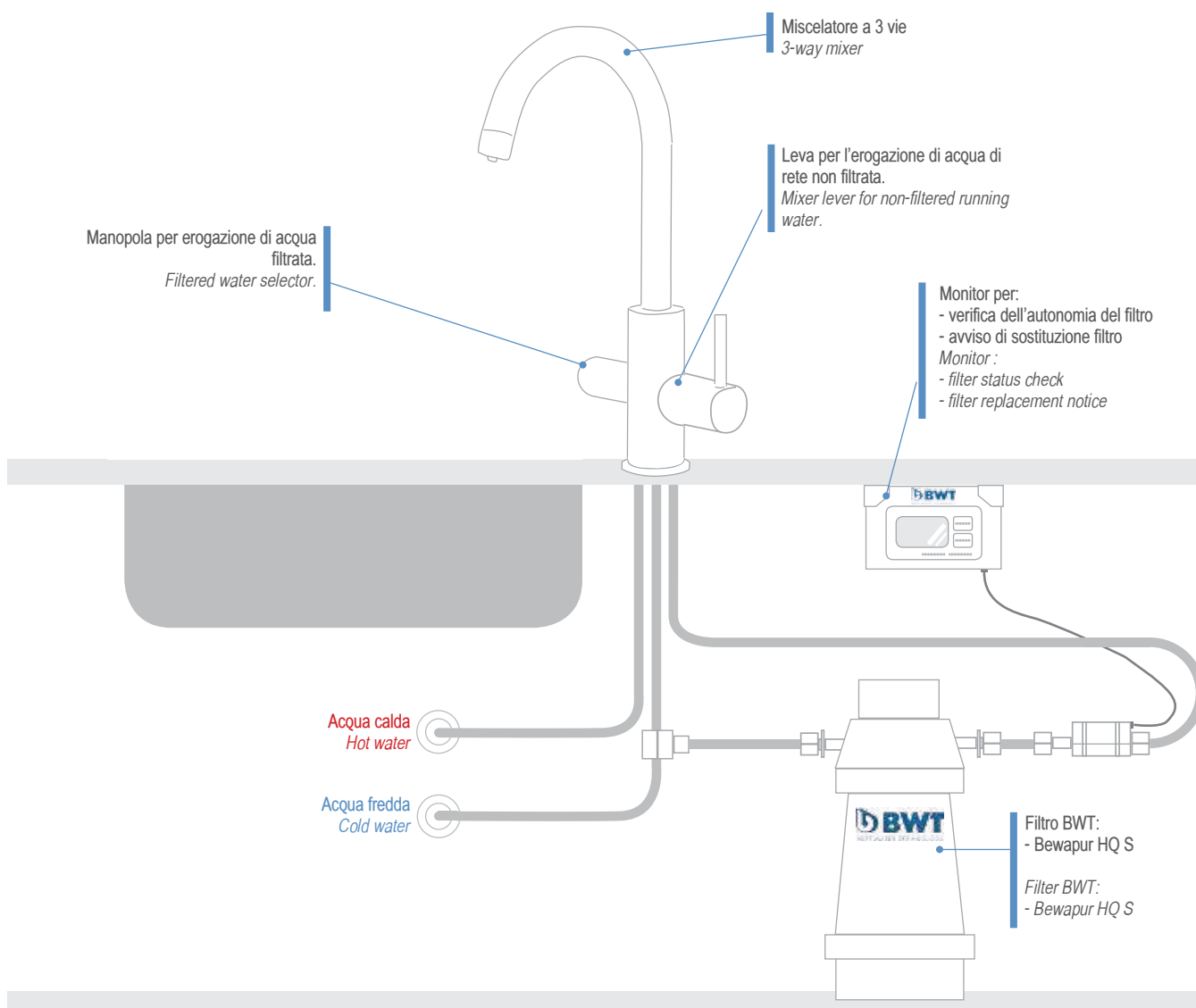

ACQUA DEPURATA - PURIFIED WATER



N792DW70J



Kit completo per acqua depurata, include: miscelatore a 3-vie con selezione acqua potabile tramite leva laterale, monitor, testata e cartuccia filtrante F70J (BWT Bewapur HQ S).

Complete kit for purified water, including: 3-way sink mixer with drinking water selection via side lever, monitor, head and F70J filter cartridge (BWT Bewapur HQ S).

CR



EY79DW70J



Kit completo per acqua depurata, include: miscelatore a 3-vie con selezione acqua potabile tramite leva laterale, monitor, testata e cartuccia filtrante F70J (BWT Bewapur HQ S).

Complete kit for purified water, including: 3-way sink mixer with drinking water selection via side lever, monitor, head and F70J filter cartridge (BWT Bewapur HQ S).

CR



L79DW70J



Kit completo per acqua depurata, include: miscelatore a 3-vie con selezione acqua potabile tramite leva laterale, monitor, testata e cartuccia filtrante F70J (BWT Bewapur HQ S).

Complete kit for purified water, including: 3-way sink mixer with drinking water selection via side lever, monitor, head and F70J filter cartridge (BWT Bewapur HQ S).

CR



KITF70J



Kit completo per acqua depurata, include: monitor, testata e cartuccia filtrante F70J (BWT Bewapur HQ S).

Complete kit for purified water, including: monitor, head and F70J filter cartridge (BWT Bewapur HQ S).

CR



F70J



Cartuccia filtrante per ricambio BWT Bewapur HQ S, autonomia 6000 litri*.

BWT Bewapur HQ S replacement filter cartridge, autonomy 6000 liters.*

CR

* L'autonomia del filtro può variare in funzione della qualità dell'acqua di alimento. Sostituire il filtro al raggiungimento dell'autonomia o al massimo dopo un anno.
 * The autonomy of the filter may vary depending on the quality of incoming water. Replace the filter upon reaching autonomy or at the latest after one year.



L79DW70J

ELEGANT KITCHEN

CUCINA ESTRAIBILI
PULL-OUT

TUTTO CUCINA
ALL KITCHEN

CUCINA COUNTRY
COUNTRY KITCHEN

ACQUA DEPURATA
PURIFIED WATER

TOUCH-ME



ACQUA CORRENTE MISCELATA
MIXED RUNNING WATER



ACQUA DEPURATA
PURIFIED WATER

Due canali di erogazione
interni differenziati.
*Two separated internal
dispensing paths.*

Bocca girevole.
Swivel spout.

Leva di miscelazione per la
tradizionale gestione dell'acqua
corrente calda e fredda.
*Mixing lever for the traditional
hot and cold running water
management.*

Selettore acqua potabile.
Ruotare di 90° in senso orario
per erogare l'acqua depurata.
*Drinking water selector.
Turn 90° clockwise to
dispense the purified water.*



N792DW



W79DW

Miscelatore lavello serie Winner a 3 vie di ingresso con bocca girevole e 2 vie d'uscita completamente indipendenti, con selezione acqua potabile tramite la leva.

3 ways inlet Winner series single lever sink mixer, with swivel spout and 2 fully independent outlets, with selection for drinking water directly from the lever.

CR	FIN 1	FIN 2
----	-------	-------



N792DW

Miscelatore lavello serie Minimal a 3 vie di ingresso con bocca girevole e 2 vie d'uscita completamente indipendenti, con selezione acqua potabile tramite la leva.

3 ways inlet minimal series single lever sink mixer, with swivel spout and 2 fully independent outlets, with selection for drinking water directly from the lever.

CR	FIN 1	FIN 2
----	-------	-------



I79DW

Miscelatore lavello serie Infinity a 3 vie di ingresso con bocca girevole e 2 vie d'uscita completamente indipendenti, con selezione acqua potabile tramite la leva.

3 ways inlet Infinity series single lever sink mixer, with swivel spout and 2 fully independent outlets, with selection for drinking water directly from the lever.

CR	FIN 1	FIN 2
----	-------	-------



V79DW

Miscelatore lavello serie Vanity a 3 vie di ingresso con bocca girevole e 2 vie d'uscita completamente indipendenti, con selezione acqua potabile tramite la leva.

3 ways inlet Vanity series single lever sink mixer, with swivel spout and 2 fully independent outlets, with selection for drinking water directly from the lever.

CR	FIN 1	FIN 2
----	-------	-------



D79DW

Miscelatore lavello serie Dream a 3 vie di ingresso con bocca girevole e 2 vie d'uscita completamente indipendenti, con selezione acqua potabile tramite la leva.

3 ways inlet Dream series single lever sink mixer, with swivel spout and 2 fully independent outlets, with selection for drinking water directly from the lever.

CR	FIN 1	FIN 2
----	-------	-------



L79DW

Miscelatore lavello serie Class Line a 3 vie di ingresso con bocca girevole e 2 vie d'uscita completamente indipendenti, con selezione acqua potabile tramite la leva.

3 ways inlet Class Line series single lever sink mixer, with swivel spout and 2 fully independent outlets, with selection for drinking water directly from the lever.

CR	FIN 1	FIN 2
----	-------	-------

TOUCH-ME

TOUCH-ME



La tecnologia TOUCH-ME integrata nei miscelatori per cucina di Remer Rubinetterie permette di azionare ed interrompere l'erogazione dell'acqua con un semplice tocco, aggiungendo ad ogni gesto quotidiano nuovi vantaggi in termini di igiene, praticità e sicurezza.

The TOUCH-ME technology integrated in Remer Rubinetterie kitchen mixers allows you to activate and stop the water supply with a simple touch, adding new advantages to every daily gesture in terms of hygiene, practicality and safety.



ELEGANT KITCHEN

CUCINA ESTRAIBILI
PULL-OUTTUTTO CUCINA
ALL KITCHENCUCINA COUNTRY
COUNTRY KITCHENACQUA DEPURATA
PURIFIED WATER

TOUCH-ME

UN TOCCO HI-TECH NELLA TUA CUCINA

La tecnologia integrata TOUCH-ME consente di aprire e chiudere l'acqua del rubinetto della cucina con un semplice tocco. Un leggero contatto con il dorso della mano o l'avambraccio vi eviterà infatti di impugnare la leva di miscelazione quando avete le mani sporche o impegnate, ottimizzando i tempi delle operazioni e preservando la pulizia del prodotto.

La modalità interattiva TOUCH-ME aggiunge nuovi vantaggi ai miscelatori per cucina Remer Rubinetterie, eccone alcuni:

PRATICITÀ : completa le tue operazioni in cucina senza interruzioni e con la libertà di usare sempre entrambe le mani.

IGIENE : non sarà più necessario impugnare la leva con le mani sporche o bagnate. E nemmeno impugnare la leva dopo essersi igienizzati le mani sotto l'acqua.

VELOCITÀ: utilizza il rubinetto in modo pratico e tempestivo, ottimizzando i tempi di tutte le operazioni in cucina. **RISPARMIO IDRICO**: la velocità del sistema TOUCH-ME elimina lo spreco dell'acqua solitamente lasciata scorrere nell'attesa di pulirsi o liberarsi le mani.

SICUREZZA: la modalità TOUCH-ME prevede un sistema di sicurezza con chiusura automatica dell'acqua dopo 45 secondi. In questo modo sarà impossibile dimenticare il rubinetto aperto.

L'installazione dei miscelatori TOUCH-ME è semplice e discreta, occupa poco spazio sotto al lavello e non richiede collegamenti alla rete elettrica (funzionamento a batterie). Alimentazione con 4 batterie al litio AA (incluse). Facile installazione salva-spazio sotto il lavello. Manuale di installazione guidata all'interno del prodotto. Tecnologia sviluppata in collaborazione con l'azienda italiana S.T.S.R. (www.stsr.it).



IT72

Miscelatore monocomando lavello, monoforo 90° con canna alta ad "C" dotata di tecnologia Touch-Me con leva laterale e bocca girevole. Dotato di cartuccia Ø35.

Single-lever sink mixer 90°, high "C" spout equipped with Touch-Me system with side lever and swivel spout. Equipped with Ø35 cartridge.

CR



LT72

Miscelatore monocomando lavello, monoforo 90° con canna alta a "C" dotata di tecnologia Touch-Me con leva laterale e bocca girevole. Dotato di cartuccia Ø35.

Single-lever sink mixer 90°, high "C" spout equipped with Touch-Me system with side lever and swivel spout. Equipped with Ø35 cartridge.

CR

A HI-TECH TOUCH IN YOUR KITCHEN

TOUCH-ME technology allows you to open and close the kitchen tap water with a simple touch. A slight contact with the back of the hand or forearm will prevent you from gripping the mixing lever when your hands are dirty or busy, optimizing operation times and preserving the cleanliness of the product.

The TOUCH-ME interactive mode adds new advantages to Remer Rubinetterie kitchen mixers, here are some of them:

CONVENIENCE: complete your kitchen operations without interruptions and with the freedom to always use both hands.

HYGIENE: it will no longer be necessary to hold the lever with dirty or wet hands. Equally it will not be necessary to hold the lever after having sanitized your hands under water.

SPEED: use the tap in a practical and timely manner, optimizing the time of all operations in the kitchen.

WATER SAVING: the speed of the TOUCH-ME system eliminates the waste of water usually left to flow while waiting to clean or free your hands.

SAFETY: the TOUCH-ME mode provides a safety system with automatic water shut-off after 45 seconds. In this way it will be impossible to forget the tap open.

The installation of the TOUCH-ME mixers is simple and discreet, takes up little space under the sink and does not require connections to the mains (battery operation). Power supply with 4 x AA lithium batteries (included). Space-saving easy installation under the sink. Guided installation manual inside the package. Technology developed in collaboration with the Italian company S.T.S.R. (www.stsr.it).



QT42U

Miscelatore monocomando lavello, monoforo 90° con canna alta ad "U" dotata di tecnologia Touch-Me con leva laterale e bocca girevole. Dotato di cartuccia Ø35.

Single-lever sink mixer 90°, high "U" spout equipped with Touch-Me system with side lever and swivel spout. Equipped with Ø35 cartridge.

CR



WT72

Miscelatore monocomando lavello, monoforo 90° con canna alta ad "C" dotata di tecnologia Touch-Me con leva laterale e bocca girevole. Dotato di cartuccia Ø35.

Single-lever sink mixer 90°, high "C" spout equipped with Touch-Me system with side lever and swivel spout. Equipped with Ø35 cartridge.

CR

L'attivazione e la disattivazione del sistema TOUCH-ME avviene con un semplice tocco. Il contatto con il miscelatore deve avvenire tramite tocco pelle-miscelatore o tramite intercessione di oggetto conduttivo tenuto da una persona.

Activation and deactivation of the TOUCH-ME system occurs with a simple touch. The contact with the mixer must occur through a direct touch skin-mixer or through a conductive object held by a person.

L'erogazione dell'acqua si interrompe automaticamente dopo un periodo di tempo prestabilito, limitando ulteriormente il contatto con il miscelatore e aumentando la sicurezza di utilizzo. Questa funzione permette un notevole risparmio idrico ed energetico, collocando il prodotto in una fascia GREEN.

The water supply stops automatically after a while, further limiting the contact with the mixer and thus increasing the usage safety.

This function allows a considerable water and energy saving, placing the product in a GREEN range.



IT72

Funzioni incluse nei miscelatori TOUCH-ME:

- Funzione TOUCH-ME: per apertura e chiusura dell'acqua con un tocco del miscelatore.
- Disattiva funzione TOUCH-ME: La modalità TOUCH-ME può sempre essere disattivata, permettendo il funzionamento del miscelatore in sola modalità manuale.
- TOCCO PROLUNGATO: il sistema riconosce un tocco veloce da un tocco prolungato quando il miscelatore è in funzione. Lo stato "aperto" del rubinetto cambia in "chiuso" solo quando il tocco è veloce, ma non cambia quando il tocco è prolungato. Questo permette di orientare la canna girevole, senza interferire con l'apertura dell'acqua.
- Funzione AUTOCHIUSURA: interrompe automaticamente l'erogazione dell'acqua dopo un periodo di tempo preimpostato di 45 secondi.

Functions included in the TOUCH-ME mixers:

- TOUCH-ME function: for opening and closing the water with a touch of the mixer.
- Deactivate TOUCH-ME function: to use the mixer in traditional mode.
- LONG TOUCH: the system recognizes a quick touch from a long touch when the mixer is in operation. The "open" status of the tap changes to "closed" only when the touch is quick, but does not change when the touch is prolonged. This allows you to orient the swivel spout without interfering with the water flow status.
- SELF-CLOSING function: automatically stops the water supply after a preset period of 45 seconds.





PUBLIC

SENSOR

SENSOR



SENSOR è una collezione di rubinetteria con sensore a infrarossi dedicata agli ambienti pubblici per il controllo dei consumi, il risparmio idrico e la sicurezza. L'utilizzo della rubinetteria avviene senza nessun contatto da parte dell'utente, garantendo quindi un alto livello di igiene anche nelle aree ad alto passaggio.

SENSOR is a collection of infrared sensor taps dedicated to public spaces for consumption control, water saving and safety. These touchless taps do not require any contact from the user, ensuring a high level of hygiene even in high-traffic areas.



SENSOR

SENSOR COLOR

TEMPOR

LEVA CLINICA
LONG LEVERSE171
SE171

RUBINETTERIA CON SENSORE A INFRAROSSI

L'utilizzo di una rubinetteria con sensore a infrarossi promuove il risparmio idrico negli ambienti pubblici, limitando i tempi di utilizzo dell'acqua alla sola necessità effettiva. La tecnologia a sensore permette inoltre di evitare qualsiasi contatto tra il rubinetto e l'utente, garantendo un alto livello di igiene anche nelle aree ad alto passaggio. Remer Rubinetterie propone una gamma completa di prodotti con tecnologia a sensore, capace di soddisfare ogni esigenza progettuale sia in termini di stile che di funzionalità. Come scegliere il rubinetto a sensore ideale? L'alta affidabilità della tecnologia a infrarossi viene proposta in molteplici varianti di design, dalle linee basiche alle forme più raffinate per integrarsi anche con gli arredi più esclusivi. I modelli sono di seguito suddivisi per tipologia di alimentazione: a batterie o con presa elettrica.

Descrizioni e simbologia vi guideranno nella scelta della soluzione più adatta al vostro progetto tra i modelli mono-acqua, con leva di regolazione della temperatura calda/fredda oppure con acqua a temperatura fissa pre-miscelata tramite rubinetti sotto-lavabo. Ogni prodotto è dotato di tutta l'elettronica e della componentistica necessarie al funzionamento, come ad esempio i rubinetti per la regolazione sotto-lavabo e le batterie.

Per evitare che le impurità dell'acqua entrino in contatto con la meccanica e per preservare la qualità del prodotto nel tempo, la rubinetteria include sistemi di filtraggio e/o prevede l'installazione di rubinetti di arresto con filtri per la pulizia dell'acqua in ingresso. Tutti i sensori sono dotati di funzionalità anti-vandalo che blocca automaticamente l'erogazione dell'acqua al superamento di un periodo di tempo prefissato e personalizzabile (a seconda del modello).

Una scelta di qualità .

Ogni modello di rubinetteria a sensore per lavabo viene progettato e prodotto in Italia all'interno degli stabilimenti di Remer Rubinetterie e integra un'elettronica prodotta dall'azienda italiana S.T.S.R. (S.T.S.R. - Studio Tecnico Sviluppo e Ricerche - Lacchiarella - Milano) a garanzia di affidabilità e durata nel tempo. Tutti i prodotti risultano conformi agli standard della certificazione CE.

INFRARED SENSOR TAPS

Using an infrared sensor tap promotes water saving in public environments, limiting the water consumption to the actual need only. The sensor technology also avoids any contact between the tap and the user, ensuring a high level of hygiene even in frequent passage areas. Remer Rubinetterie offers a complete range of faucets with sensor technology, capable of satisfying every design need both in terms of style and functionality. How to choose the perfect sensor tap? The high reliability of infrared sensor technology is proposed in multiple design variants, from basic lines to more refined shapes to integrate with even the most exclusive furnishings. The faucet models in this document are firstly sorted by the type of supply: batteries or electrical plug.

Descriptions and symbols will also guide you in choosing the most suitable solution for your project among the models with mono-water supply, with hot / cold temperature adjustment or with a fixed temperature of pre-mixed water via under-sink angle valves. Each product is equipped with all the electronics and components necessary for operation, such as angle valves for under-sink adjustment and batteries.

To prevent the impurities of the water from coming into contact with the mechanics and to preserve the quality of the product over time, the taps include filtering systems and/or require the installation of stopcocks with filters for cleaning the inlet water . All sensors are equipped with anti-vandal functionality that automatically blocks the water supply after exceeding a predetermined and customizable (depending on the model) period of time.

A choice of quality .

Each sensor basin mixer model is designed and produced in Italy within Remer Rubinetterie's factories and integrates electronics provided by the Italian company S.T.S.R. (S.T.S.R. - Technical Development and Research Studio - Lacchiarella - Milan) to guarantee reliability and durability. All products comply with CE certification standards.

ALIMENTAZIONE BATTERIA - BATTERY POWER SUPPLY



Pressione di lavoro: 1 --> 6 Bar

Temperatura acqua: 65° C max

Diametro di entrata: Ø G 1/2 M

Raggio d'azione di riconoscimento: 10 cm circa, predisposto

Alimentazione elettrica: 4 batterie litio da 1,5 V tipo AA

Portabatterie adesivizzabile IPX5

Connessioni IPX5

Working pressure: 1-6 Bar

Water temperature max: 65° C max

Input: Ø G 1/2 M

Recognition range: about 10 cm adjustable

Electrical connection: 4 lithium 1,5 V batteries type AA

Adhesive Battery Holder IPX5

IPX5 connections

SENSOR

**SE171**

Rubinetto elettronico ad azionamento a sensore con regolazione acqua caldo/freddo tramite due rubinetti sottolavabo con filtro.

Electronic tap, with sensor control, for pre-mixed water equipped with two angle valves with filter.

CR

**SE171L**

Rubinetto alto elettronico ad azionamento a sensore con regolazione acqua caldo/freddo tramite due rubinetti sottolavabo con filtro.

Electronic high tap, with sensor control, for pre-mixed water equipped with two angle valves with filter.

CR

SENSOR COLOR

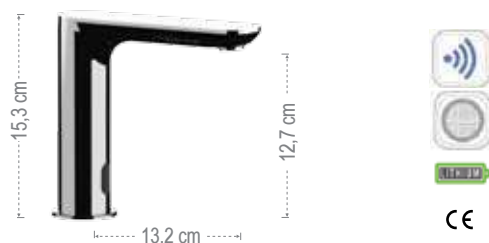
**SE161**

Rubinetto elettronico ad azionamento a sensore, **mono-acqua** dotato di rubinetto sottolavabo con filtro.

Electronic single water tap, with sensor control, equipped with angle valve with filter.

CR

**SE161L**

Rubinetto alto elettronico ad azionamento a sensore, **mono-acqua** dotato di rubinetto sottolavabo con filtro.

Electronic high single water tap, with sensor control, equipped with angle valve with filter.

CR

TEMPOR

LEVA CLINICA
LONG LEVER

SENSOR

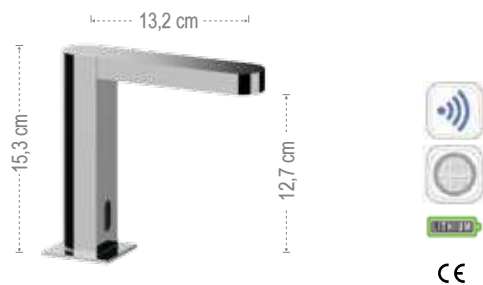

SE17

Rubinetto elettronico ad azionamento a sensore con regolazione acqua caldo/freddo tramite due rubinetti sottolavabo con filtro.
Electronic tap, with sensor control, for pre-mixed water equipped with two angle valves with filter.

CR

CE

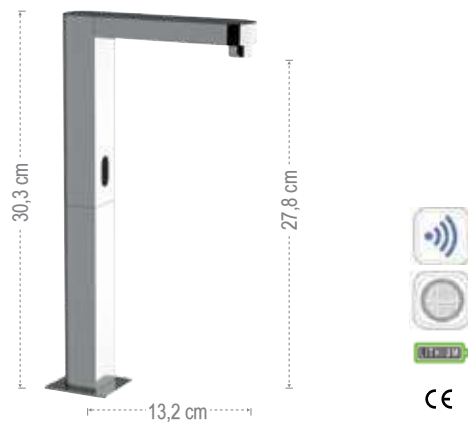

SE17L

Rubinetto alto elettronico ad azionamento a sensore con regolazione acqua caldo/freddo tramite due rubinetti sottolavabo con filtro.
High electronic tap, with sensor control, for pre-mixed water equipped with two angle valves with filter.

CR

CE



SE16

Rubinetto elettronico ad azionamento a sensore, **mono-acqua** dotato di rubinetto sottolavabo con filtro.
Electronic single water tap, with sensor control, equipped with angle valve with filter.

CR

CE

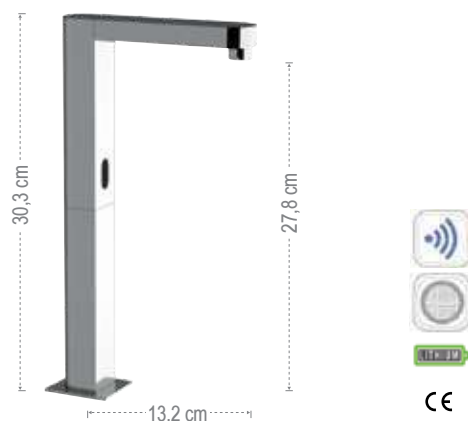

SE16L

Rubinetto alto elettronico ad azionamento a sensore, **mono-acqua** dotato di rubinetto sottolavabo con filtro.
High electronic single water tap, with sensor control, equipped with angle valve with filter.

CR

CE

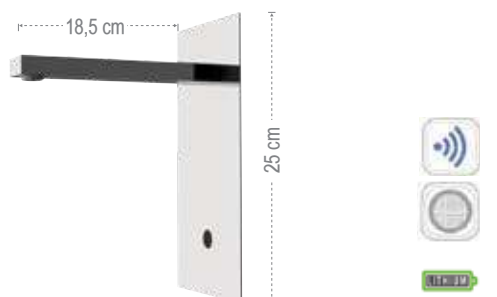

SE28Q

Rubinetto lavabo ad incasso a sensore monoacqua.
Built-in wash basin sensor mixer single water.

CR

CE

ALIMENTAZIONE ELETTRICA - ELECTRICAL POWER SUPPLY



Pressione di lavoro: 1 --> 6 Bar

Temperatura acqua: 65° C max

Diametro di entrata: Ø G 1/2 M

Raggio d'azione di riconoscimento: 10 cm circa, predisposto

2 modalità di funzionamento selezionabili (basso consumo/alta reattività)

Omologazione CE

Connessioni IP67

Working pressure: 1-6 Bar

Water temperature max: 65° C max

Input: Ø G 1/2 M

Recognition range: about 10 cm adjustable

2 selectable operation modes (low-consumption/high reactivity)

CE approved

IP67 connections

SENSOR

**SE1171**

Rubinetto elettronico ad azionamento a sensore con regolazione acqua caldo/freddo tramite due rubinetti sottolavabo con filtro.

Electronic tap, with sensor control, for pre-mixed water equipped with two angle valves with filter.

CR

**SE1171L**

Rubinetto alto elettronico ad azionamento a sensore con regolazione acqua caldo/freddo tramite due rubinetti sottolavabo con filtro.

Electronic high tap, with sensor control, for pre-mixed water equipped with two angle valves with filter.

CR

SENSOR COLOR

**SE1161**

Rubinetto elettronico ad azionamento a sensore, **mono-acqua** dotato di rubinetto sottolavabo con filtro.

Electronic single water tap, with sensor control, equipped with angle valve with filter.

CR

**SE1161L**

Rubinetto alto elettronico ad azionamento a sensore, **mono-acqua** dotato di rubinetto sottolavabo con filtro.

Electronic high single water tap, with sensor control, equipped with angle valve with filter.

CR

TEMPOR

LEVA CLINICA
LONG LEVER

SENSOR



SE117L

Rubinetto elettronico alto per lavabo con azionamento a sensore, per acqua premiscelata, dotato di due rubinetti sottolavabo con filtro.
High electronic tap, with sensor control, for pre-mixed water equipped with two angle valves with filter.

CR



SE117

Rubinetto elettronico per lavabo con azionamento a sensore, per acqua premiscelata, dotato di due rubinetti sottolavabo con filtro.
Electronic tap, with sensor control, for pre-mixed water equipped with two angle valves with filter.

CR

SE116L

Rubinetto elettronico alto **mono-acqua** per lavabo con azionamento a sensore, dotato di rubinetto sottolavabo con filtro.
High electronic single water tap, with sensor control, equipped with angle valve with filter.

CR

SE116

Rubinetto elettronico **mono-acqua** per lavabo con azionamento a sensore, dotato di rubinetto sottolavabo con filtro.
Electronic single water tap, with sensor control, equipped with angle valve with filter.

CR



SE117

ARTICOLI COMPLEMENTARI - *COMPLEMENTARY ITEMS*

SE30
Rubinetto elettronico a incasso per orinatoio.
Urinal electronic built-in flusher.

CR

Pressione di lavoro: 1 – 6 Bar
Diametro di entrata: G1/2
Azionamento: elettrovalvola integrata
Raggio d'azione di riconoscimento: 30 – 60 cm, regolabile
Alimentazione elettrica: DC 4.5V tre batterie alcaline "AAA" da 1.5V
Installazione: montaggio ad incasso.

Working pressure: 1-6 Bar

Input: Ø G 1/2

Control valve: solenoid valve

Recognition range: 30-60 cm adjustable

Electrical connection: DC 4.5 V with 3 1,5 V alkaline batteries type AAA

Installation: built-in

SENSOR



SE33
Rubinetto elettronico esterno per orinatoio.
Urinal electronic external flusher.

CR

Pressione di lavoro: 1 – 6 Bar
Diametro di entrata: G1/2
Raggio d'azione di riconoscimento: 35 cm, predisposto.
Alimentazione elettrica: DC 6V quattro batterie alcaline "AAA" da 1.5V
Modalità di installazione: esterno

Working pressure: 1-6 Bar

Input: Ø G 1/2

Recognition range: 35 cm adjustable

Electrical connection: DC 6V with 4 1,5 V alkaline batteries type AAA

Installation: external mounted

SENSOR COLOR



SE71
Dispenser a sensore per sapone liquido e liquido disinfettante.
Sensor dispenser for liquid soap and liquid disinfectant.

CR

Capacità: 650 ml

Batteria: 6 x 1,5 V

Capacity: 650 ml

Battery: 6 x 1,5 V

TEMPOR

**SEPWKIT**

Kit composto da:

connettore per alimentazione elettrica dei dispositivi elettronici, con commutazione automatica a batteria in caso di mancanza energia elettrica ed alimentatore a 6V, in scatola (da utilizzare con batterie alcaline).

Kit composed of:

power supply jointer with battery back-up function and power supply 6V, in box (for use with alkaline batteries).

CR

LEVA CLINICA
LONG LEVER

SENSOR COLOR

SENSOR COLOR



I modelli di rubinetteria a sensore SENSOR COLOR si rivolgono agli ambienti pubblici più prestigiosi, aggiungendo una scenografica luce led alle funzionalità di igiene e controllo dei consumi.

SENSOR COLOR tap models are created for the most exclusive public spaces, adding a spectacular LED light to the hygiene and consumption control functions.

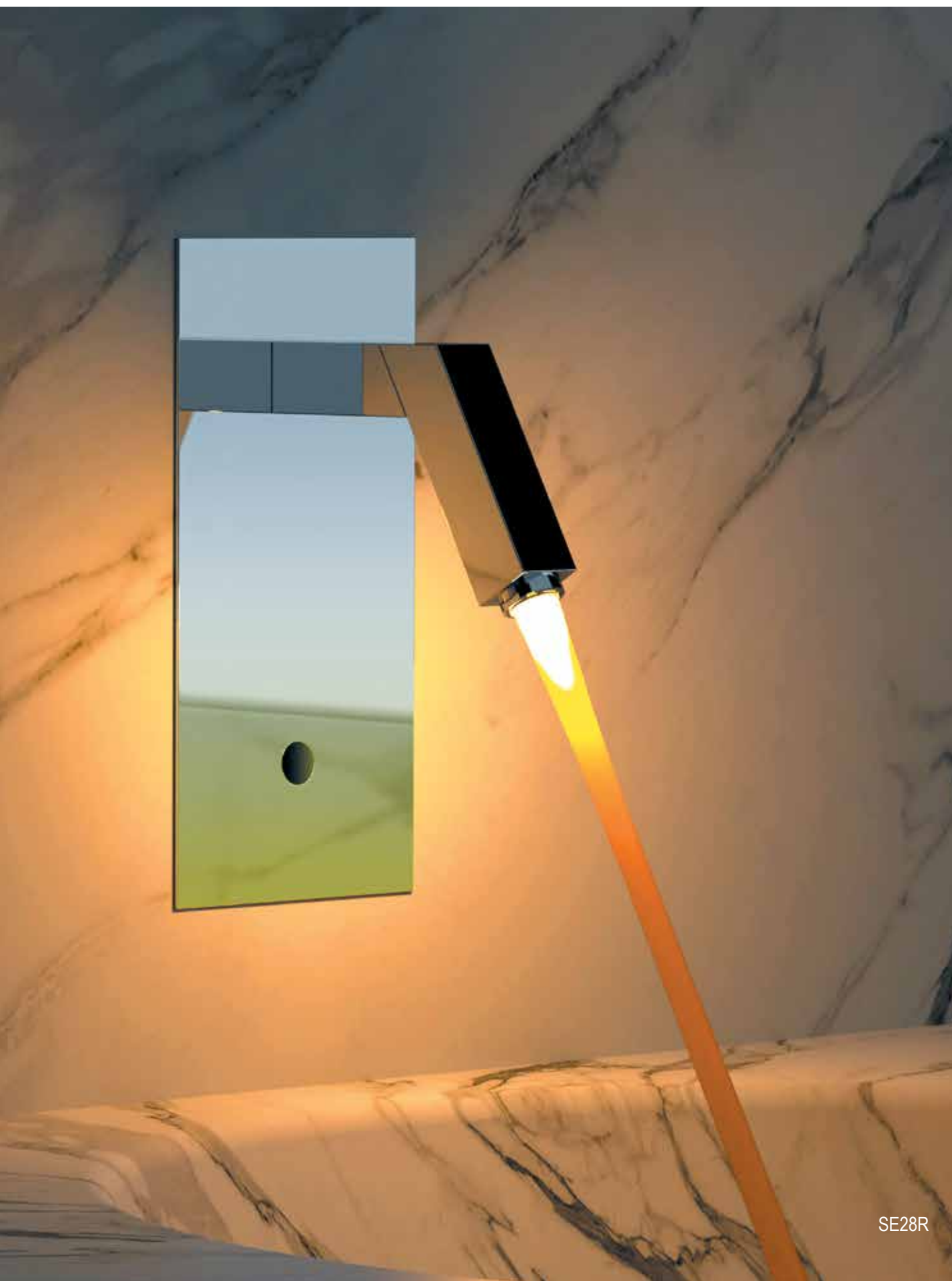

SENSOR

SENSOR COLOR

TEMPOR

LEVA CLINICA
LONG LEVER

RUBINETTERIA A SENSORE CON LUCE LED

Nei modelli di rubinetteria SENSOR COLOR di Remer Rubinetterie, l'efficienza della tecnologia a sensore infrarossi viene personalizzata da un'originale luce led colorata. Grazie alla tecnologia COLOR LED LIGHT all'interno del miscelatore, infatti, il semplice passaggio dell'acqua genera una delicata luce bianca o multi colore che ne accompagna il fluire e che si diffonde nello spazio circostante. Ogni prodotto include tutta l'elettronica e la componentistica necessarie al funzionamento.

SENSOR TAPS WITH LED LIGHT

With SENSOR COLOR faucets by Remer Rubinetterie, the efficiency of the infrared sensor technology is featured by an original colored LED light. Thanks to the COLOR LED LIGHT technology inside the mixer, the simple passage of water generates a delicate white or multi-colored light that follows the flow and spreads into the surrounding space. Each product includes all the electronics and components necessary for operation.

TECNOLOGIA COLOR LED LIGHT

La tecnologia COLOR LED LIGHT inserita nei modelli SENSOR COLOR é disponibile in quattro varianti di performance led:

COLOR LED LIGHT TECHNOLOGY

COLOR LED LIGHT technology is available in four LED performance variants:

A 

La luce emanata è solo bianca
The emitted light is white only

B 

Il colore della luce cambia con la temperatura dell'acqua (Azzurro: fino a 32° Bianco : da 32° a 38° Rosa: oltre 38°)

The color of the light changes following the water temperature (Light blue: up to 32°, White: from 32° to 38°, Pink: over 38°)

C 

Il colore della luce cambia con la temperatura dell'acqua (Blu: fino a 28°, Verde: da 28° a 33°, Giallo: da 33° a 38°, Rosso: da 38°)

The color of the light changes following the water temperature (Blue: up to 28°, Green: from 28° to 33°, Yellow: from 33° to 38°, Red: from 38°)

D 

8 colori e sfumature si alternano in un continuo arcobaleno, indipendentemente dalla temperatura.
8 colors and shades alternate in a continuous rainbow, regardless of the temperature



Le temperature indicate possono variare di circa +/-2 gradi. Per confermare la variante prescelta, aggiungere la lettera corrispondente alla fine del codice prodotto al momento dell'ordine.

Temperatures may vary by approximately +/- 2 degrees. To confirm the chosen variant, add the corresponding letter at the end of the item code during the purchase phase.

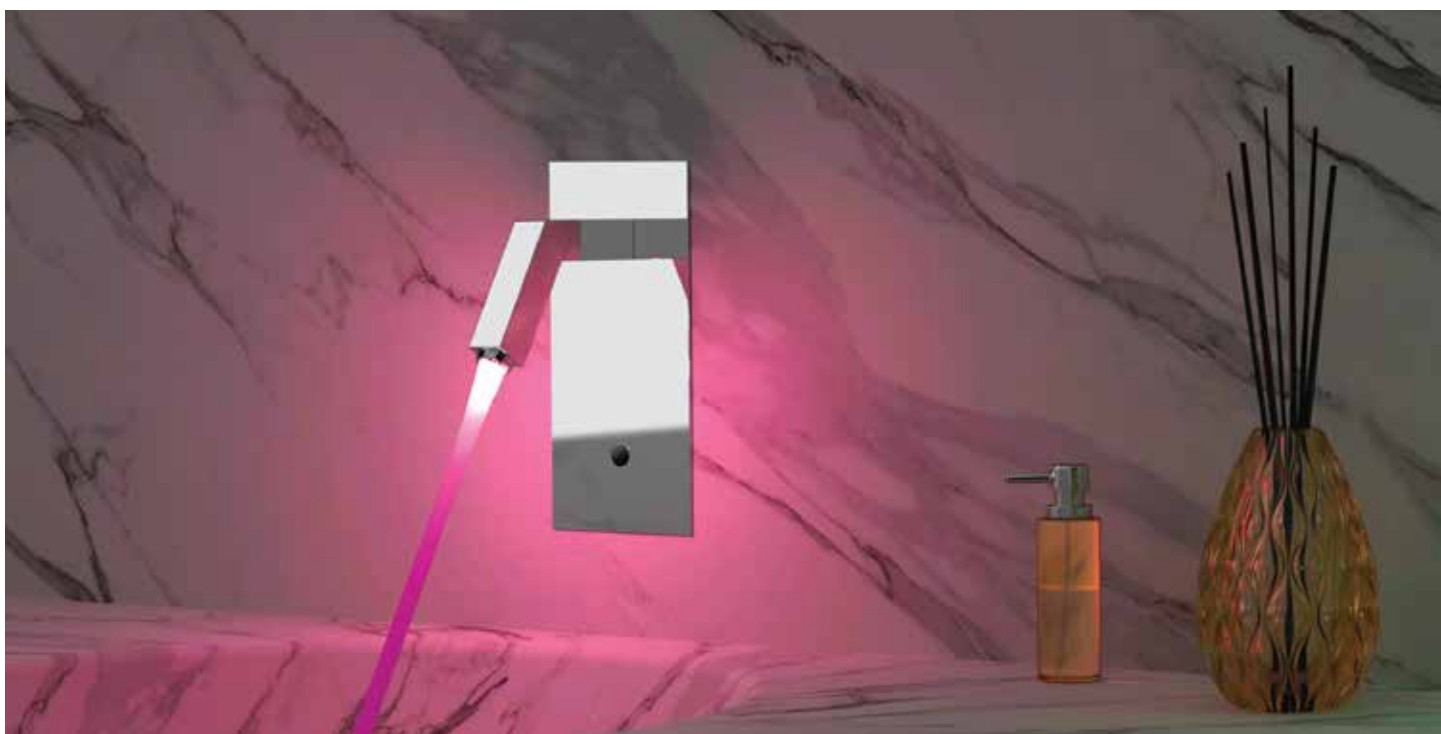

LUCE LED A COLORI - *COLOR LED LIGHT*



Pressione di lavoro: 1 --> 6 Bar

Temperatura acqua: 65° C max

Diametro di entrata: Ø G 1/2 M

Raggio d'azione di riconoscimento: 10 cm circa, predisposto

Portabatterie adesivizzabile IPX5

Conessioni IPX5

Working pressure: 1-6 Bar

Water temperature max: 65° C max

Input: Ø G 1/2 M

Recognition range: about 10 cm adjustable

Adhesive Battery Holder IPX5

IPX5 connections



SE28R

Rubinetto lavabo ad incasso a sensore, con luce led, monoacqua o premiscelata.

Built in wash basin sensor mixer, single water or premixed, with color device.

CR

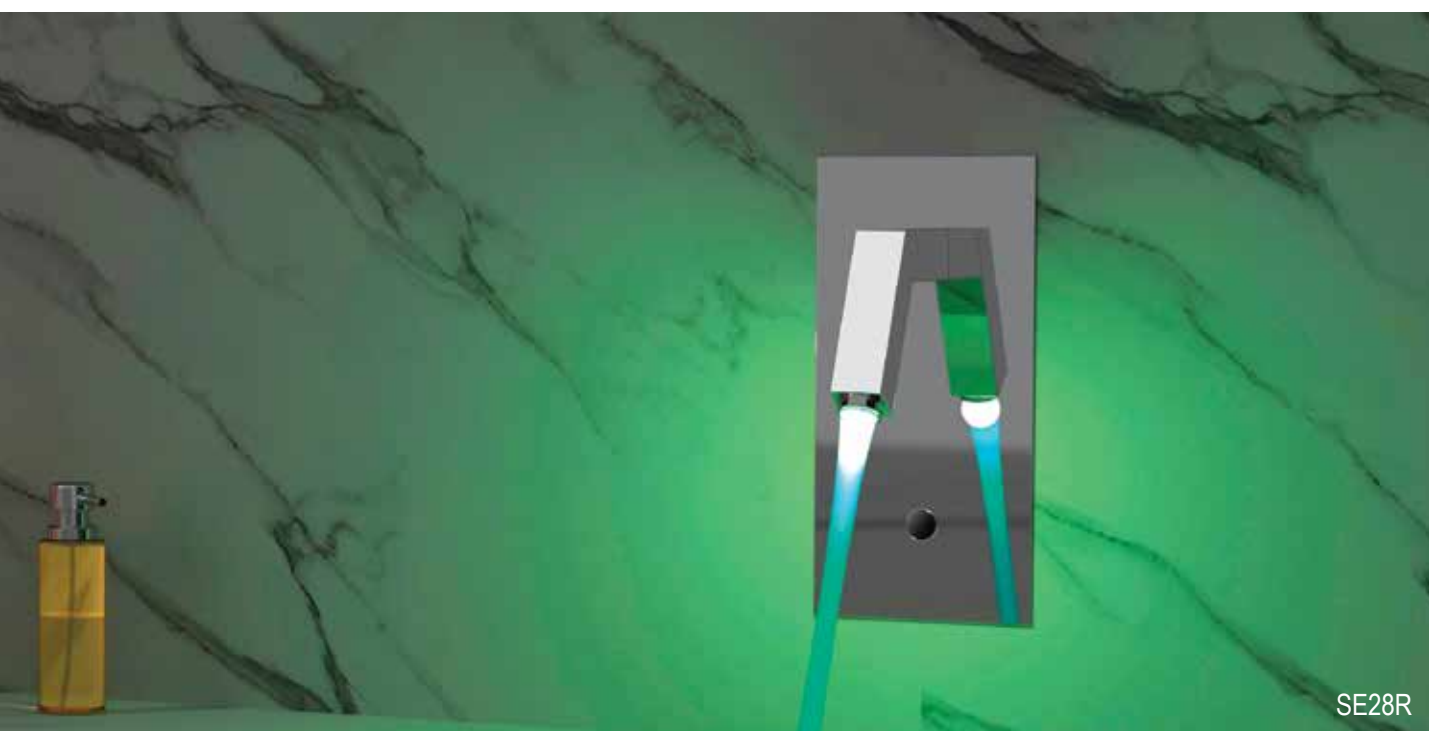

SE28R

SENSOR

SENSOR COLOR

TEMPOR

LEVA CLINICA
LONG LEVER

TEMPOR

TEMPOR



In ambienti pubblici la rubinetteria temporizzata rende un servizio importante in termini di risparmio idrico e razionalizzazione dell'uso dell'acqua.
I rubinetti della serie Tempor sono articoli funzionali che si caratterizzano di design diversi per vestire adeguatamente ogni soluzione estetica, sia essa di design, moderna o più tradizionale.

*In public places the temporised timer mixers give an important service in terms of water saving and rationalisation of the use of water.
Tempor taps are functional items that are characterised of different designs to meet properly every aesthetical solution, of design, modern or more traditional.*



SENSOR

SENSOR COLOR

TEMPOR

LEVA CLINICA
LONG LEVER

LAVABI - WASHBASIN MIXERS



TE15

Rubinetto temporizzato a collo cigno, 1/2", in ottone, tempo d'apertura 6-8 secondi.

Temporized (timer) pillar tap, 1/2", all in brass, opening time 6-8 seconds.

CR



TE16

Rubinetto temporizzato a collo cigno, 1/2", in ottone, tempo d'apertura 6-8 secondi.

Temporized (timer) pillar tap, 1/2", all in brass, opening time 6-8 seconds.

CR



TE18

Rubinetto temporizzato a collo cigno, Minimal, 1/2", in ottone, tempo d'apertura 6-8 secondi.

Temporized (timer) pillar tap, 1/2", Minimal, all in brass, opening time 6-8 seconds.

CR



TE18M

Rubinetto miscelatore temporizzato a collo cigno con maniglia per la selezione dell'acqua calda/fredda, serie minimal, 1/2", in ottone, tempo di apertura 6-8 secondi.

Temporized (timer) mixer pillar tap with hot/cold water selection handle, serie minimal. 1/2", in brass, opening time 6-8 seconds.

CR



TE225

Rubinetto frontale temporizzato, 1/2", in ottone, tempo d'apertura 6-8 secondi.

Temporized (timer) frontal mounted 1/2" tap, all in brass, opening time 6-8 seconds.

CR



TE53

Rubinetto frontale temporizzato, con canna "S", 1/2", in ottone, tempo d'apertura 6-8 secondi.

Temporized (timer) frontal mounted, with "S" spout, 1/2" tap, all in brass, opening time 6-8 seconds.

CR



TE41M

Miscelatore a muro temporizzato per lavello con canna girevole.

Wall mounted temporized sink mixer, with movable spout.

CR



TEVI

Cartuccia di ricambio per rubinetti temporizzati art. TE 15, TE 16, TE 53, TE 225, TE 855.

Spare cartridge for temporized (timer) taps art. TE 15, TE 16, TE 53, TE 225, TE 855.

CR

TOILET

**TE171**

Flussometro temporizzato a incasso, a pulsante, per wc, 3/4, 1", tempo d'apertura 6-8 secondi.
Temporized (timer) built-in tap, for wc, 3/4, 1", opening time 6-8 seconds.

CR

**TE171Q**

Flussometro temporizzato a incasso quadrato a pulsante per wc, 3/4, 1", tempo d'apertura 6-8 secondi.
Temporized (timer) built-in squared tap for wc, 3/4, 1", opening time 6-8 seconds.

CR

**856**

Spartiacque per orinatoio, attacco Ø 15, con tubo Ø 15 mm.
Water divide for urinals, connection Ø 15, with pipe Ø 15 mm.

CR

**332TEL**

Set composto da: doccia a pulsante, flessibile conico cm 120, rubinetto temporizzato 1/2" in ottone, tempo d'apertura 6-8 secondi.
Set composed of: shut-off handshower, flexible cm 120, temporized button flusher 1/2" all in brass, opening time 6-8 seconds.

CR

**RB100TE**

Set composto da: idroscopio a pulsante in ottone, flessibile conico cm 120, rubinetto temporizzato 1/2" in ottone, tempo d'apertura 6-8 secondi.
Set composed of: hydro brush in brass, flexible cm 120, temporized button flusher 1/2" all in brass, opening time 6-8 seconds.

CR

**TE855**

Rubinetto temporizzato a pulsante per orinatoio, 1/2", in ottone, completo di rosoni, di due tubetti Ø mm 14 e guarnizione. Tempo d'apertura 6-8 secondi.
Temporized (timer) urinal button flusher, 1/2", in brass, in a set with flanges, two copper tubes Ø mm 14 and a washer. Opening time 6-8 seconds.

CR



Flussometro temporizzato a pulsante esterno per WC, in ottone, tempo d'apertura 6-8 secondi, misure: 3/4, 1".
Temporized (timer) wall mounted tap, for wc, in brass, opening time 6-8 seconds: 3/4, 1".

CR

TE17010 1"

CR

TE17034 3/4**170TU**

Tubo a "L" per flussometro esterno, in ottone, Ø 25, 30.
"L" brass pipe, for wall mounted tempor tap for wc, Ø 25, 30.

CR

170TU25 Ø 25

CR

170TU30 Ø 30

SENSOR

SENSOR COLOR

TEMPOR

LEVA CLINICA
LONG LEVER

DOCCIA - SHOWER MIXERS



351AVS

Soffione doccia antivandalo ed antimpiccagione con getto fisso.
Antivandal and antiligature shower head with fix spray.

CR



351AV

Soffione doccia antivandalo ed antimpiccagione con getto regolabile.
Antivandal and antiligature shower head with adjustable spray.

CR



TE31

Rubinetto temporizzato a pulsante per doccia esterno, 1/2"x1/2", in ottone, tempo d'apertura 18-20 secondi.
Temporized (timer) tap for shower, 1/2"x1/2", external, all in brass, opening time 18-20 seconds.

CR



TE30M

Miscelatore doccia temporizzato da incasso.
Built-in temporized shower mixer.

CR



TE32M

Miscelatore doccia temporizzato da incasso.
Built-in temporized shower mixer.

CR



TEVI30

Cartuccia di ricambio per rubinetti temporizzati art. TE 30 - TE 31.
Spare cartridge for temporized (timer) taps art. TE 30 - TE 31.

CR



TE53329EX351

Rubinetto frontale temporizzato, colonna doccia 1/2" x 3/4" e soffione doccia standard, tempo d'apertura 6-8 secondi.
Temporized (timer) frontal mounted, with stand pipe 1/2" x 3/4" and standard shower head, opening time 6-8 seconds.

CR



66
Rubinetto a pedale ad incasso in ottone.
Built in tap foot operated, in brass.

CR



TE30
Rubinetto per doccia incasso temporizzato 1/2",
tempo d'apertura 18-20 secondi.
*Temporized (timer) wall mounted tap 1/2",
opening time 18-20 seconds.*

CR



TE30Q
Rubinetto per doccia incasso temporizzato
quadrato, 1/2", in ottone, tempo d'apertura 18-20
secondi.
*Temporized (timer) wall mounted squared tap,
1/2", opening time 18-20 seconds.*

CR



SENSOR



66MP
Rubinetto-miscelatore pedaliera universale. Può
essere installato sia a parete che a pavimento.
*Treadle mixer with universal pedal control. It can
be installed both on the wall and on the floor.*

CR



69
Rubinetto a pulsante a zampillo parabolico per
refrigeratore o depuratore. Regolazione del getto
sotto il pulsante.
*Parabolic jet button tap for refrigerator or purifier.
Water flow control under the button.*

CR

SENSOR COLOR



TEMPOR

LEVA CLINICA
LONG LEVER

LEVA CLINICA - LONG LEVER

LEVA CLINICA LONG LEVER



I lavabi con leva clinica sono progettati per garantire un'elevata igiene e facilità d'uso in contesti pubblici e professionali. Grazie al sistema a leva, gli utenti possono attivare il flusso d'acqua senza contatto diretto con il rubinetto, contribuendo a mantenere un ambiente pulito e sicuro.

Clinical lever sinks are designed to ensure high hygiene standards and ease of use in public and professional settings. With the lever system, users can activate the water flow without direct contact with the faucet, helping to maintain a clean and safe environment.



SENSOR

SENSOR COLOR

TEMPOR

LEVA CLINICA
LONG LEVER

LEVA CLINICA - LONG LEVER

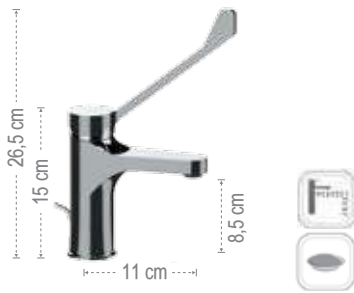

LL10
Miscelatore monocomando lavabo, con scarico.
Single-lever basin mixer, with pop-up waste.

CR



LL10L
Miscelatore monocomando lavabo alto L, con scarico.
L high single lever basin mixer, with pop-up waste.

CR



LL10LACC
Miscelatore monocomando per lavabo, modello "A" altezza media, scarico click-clack con troppopieno incluso.
Single-lever basin mixer, model "A" medium height, click-clack waste with overflow included.

CR



LL12
senza scarico e senza foro sul corpo.
without waste and without body hole.

CR



LL12L
Miscelatore monocomando lavabo alto L, senza scarico e senza foro sul corpo.
L high single lever basin mixer, without waste and without body hole.

CR



LL12LA
Miscelatore monocomando per lavabo, modello "A" altezza media, senza scarico e senza foro sul corpo.
Single-lever basin mixer, model "A" medium height, without pop-up waste and with no rear hole.

CR



LL10LXL
Miscelatore monocomando lavabo alto XL, con scarico click-clack con troppopieno.
XL high basin mixer, with click-clack waste and overflow.

CR



LL11LXL
Miscelatore monocomando lavabo alto XL, senza scarico.
XL high basin mixer, without waste.

CR



LL77E
Miscelatore monocomando lavello a molla con doccetta estraibile ed orientabile a due funzioni e cartuccia Ø 35 mm.
Spring single-lever sink mixer with detachable and adjustable 2-functions hand shower and Ø 35 mm cartridge.

CR

**LL72**

Miscelatore monocomando monoforo, serie class line con canna alta a "U" girevole.

Single-lever sink mixer, class line series high movable "U" spout.

CR

**LL42**

Miscelatore monocomando per lavello con bocca alta girevole, tipo lusso.

Single lever one-hole sink mixer with high movable spout, luxury type

CR

**LL42R**

Miscelatore monocomando per lavello con bocca alta e abbattibile, modello sotto-finestra.

Single-lever one-hole sink mixer with high and foldable spout, under-window type.

CR

**LL42U**

Miscelatore monocomando per lavello con bocca alta a "U" girevole.

Single lever one-hole sink mixer with high "U" movable spout.

CR

**LL40**

Miscelatore monocomando per lavello con bocca girevole.

Single lever one-hole sink mixer with movable spout.

CR



Miscelatore monocomando a muro per lavello con bocca girevole.

Wall mounted single-lever sink mixer with movable spout.

CR

LL41 20 cm

CR

LL4130 30 cm

CR

LL4140 40 cm

CR

LL4150 50 cm

CR

SENSOR

SENSOR COLOR

TEMPOR

LEVA CLINICA
LONG LEVER





ACCESSORI BAGNO

BATH ACCESSORIES

SHUT-OFF



SHUT-OFF



X61PW

Set per doccetta igienica shut-off con cartuccia progressiva: apertura su acqua fredda e passaggio progressivo ad acqua calda tramite rotazione del supporto. Il sistema di sicurezza integrato impedisce di aprire l'acqua quando la doccetta è inserita nel supporto e di riporre la doccetta prima di aver chiuso completamente la cartuccia. Set comprensivo di doccetta a pulsante in ottone e tubo flessibile cm 120. Cartuccia: d.25.

Set for body cleaning with progressive cartridge: opening on cold water and progressive transition to hot water by rotating the support. The integrated safety system prevents both turning on the water when the hand shower is placed in its holder and putting the hand shower back in the holder before having completely turned off the water. Set including brass shut-off hand shower and 120 cm flexible hose. Cartridge: d.25.

CR

FIN 1

FIN 2



X65C25W

Set per doccetta igienica shut-off comprensivo di miscelatore a incasso con supporto doccia e presa acqua, doccetta in ottone con apertura a pulsante, tubo flessibile 120 cm. Cartuccia d.25.

Set for body cleaning including, built-in mixer with shower holder and water intake, cylindrical brass hand shower with shut-off system, 120 cm flexible hose. Cartridge d.25.

CR

FIN 1

FIN 2

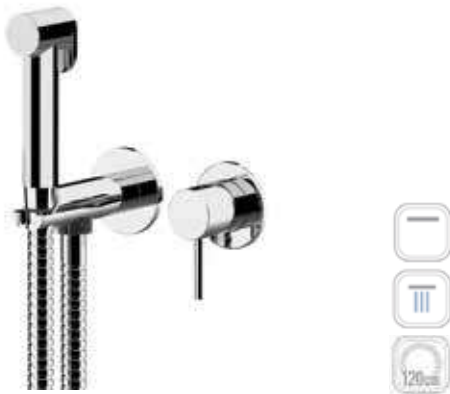

X63REWMVA

Miscelatore incasso per shut-off su piastre separate, comprensivo di doccetta shut-off art. 332OW, supporto doccia-presa acqua con valvola di sicurezza e flessibile doccia cm 120. NB: Le due parti a incasso sono indipendenti tra loro e permettono di posizionare i singoli elementi liberamente in base alle esigenze del progetto.

Built-in shower mixer set on double flange, including shut-off art. 332OW, shower holder water punch with safety valve and shower flexible cm 120. NB: The two built-in parts are independent of each other and allow the individual elements to be positioned freely according to each project needs.

CR



X65C25TW

Set per doccetta igienica shut-off comprensivo di miscelatore a incasso con leva minimale e presa acqua esterna, mensola portaoggetti integrata 100x210mm con supporto per doccetta, doccetta a pulsante in ottone, tubo flessibile 120cm.

Set for body cleaning including built-in mixer with minimal lever and external water connection, 100x210mm shelf with hand shower holder, brass hand shower with shut-off system, 120cm flexible hose.

CR

SHUT-OFF PROGRESSIVO - PROGRESSIVE SHUT-OFF



Q64

Miscelatore shut-off quadrato con cartuccia progressiva, apertura su acqua fredda e passaggio ad acqua calda tramite rotazione di maniglia unica, comprensivo di doccetta shut-off 332OS e flessibile cm 120.

Shut-off square mixer with progressive cartridge, opening with cold water, switching on hot water by rotating one single handle including shut-off 332OS and flexible hose 120 cm.

CR

FIN 1

FIN 2



N64W

Miscelatore shut-off serie Minimal con cartuccia progressiva, apertura su acqua fredda e passaggio ad acqua calda tramite rotazione di maniglia unica, comprensivo di doccetta shut-off 332OW e flessibile cm 120.

Shut-off mixer Minimal series with progressive cartridge, opening with cold water, switching on hot water by rotating one single handle including shut-off 332OW and flexible hose 120 cm.

CR

FIN 1

FIN 2

SHUT-OFF

PLACCHE WC
TOILET PLATES

LAVABO
WASHBASIN

LOUNGE

FLAT

GUEST

SUITE

EPOCA

ACCESSORI
ACCESSORIES

IDROSCOPINI
HYDRO-BRUSH

COMPLEMENTI
COMPL. ITEMS

RICAMBI
SPARE PARTS

MISCELATORI INCASSO - *BUILT-IN MIXERS*



N63
Miscelatore incasso per shut-off.
Built-in shut-off mixer.

CR



Z63
Miscelatore incasso per shut-off.
Built-in shut-off mixer.

CR



L63
Miscelatore incasso per shut-off.
Built-in shut-off mixer.

CR



Q63
Miscelatore incasso per shut-off.
Built-in shut-off mixer.

CR



S633
Miscelatore incasso per shut-off.
Built-in shut-off mixer.

CR

MISCELATORI SHUT-OFF - *SHUT-OFF MIXERS*



D60
Miscelatore incasso shut-off serie Dream comprensivo di: doccetta shut-off 332OL, supporto doccia presa acqua su piastra in ottone e flessibile cm 120.
Built-in shower mixer set Dream series including: shut-off 332OL, shower holder water punch on flange all in brass and flexible hose cm 120.

CR



N60
Miscelatore incasso shut-off serie Minimal comprensivo di: doccetta shut-off 332OL, supporto doccia presa acqua su piastra in ottone e flessibile cm 120.
Built-in shut-off mixer set Minimal series including: shut-off 332OL, shower holder water punch on flange, all in brass and flexible hose cm 120.

CR



I60
Miscelatore incasso shut-off serie Infinity comprensivo di: doccetta shut-off 332OL, supporto doccia presa acqua su piastra in ottone e flessibile cm 120.
Built-in shut-off mixer set Infinity series including: shut-off 332OL, shower holder water punch on flange, all in brass and flexible hose cm 120.

CR



D60W
Miscelatore incasso shut-off serie Dream comprensivo di: doccetta shut-off 332OW, supporto doccia presa acqua su piastra in ottone e flessibile cm 120.
Built-in shower mixer set Dream series including: shut-off 332OW, shower holder water punch on flange all in brass and flexible hose cm 120.

CR



N60W
Miscelatore incasso shut-off serie Minimal comprensivo di: doccetta shut-off 332OW, supporto doccia presa acqua su piastra in ottone e flessibile cm 120.
Built-in shut-off mixer set Minimal series including: shut-off 332OW, shower holder water punch on flange, all in brass and flexible hose cm 120.

CR



I60W
Miscelatore incasso shut-off serie Infinity comprensivo di: doccetta shut-off 332OW, supporto doccia presa acqua su piastra in ottone e flessibile cm 120.
Built-in shower mixer set Infinity series including: shut-off 332OW, shower holder-water punch on flange, all in brass and flexible hose cm 120.

CR



S603

Miscelatore incasso shut-off serie SQ3 comprensivo di: doccetta shut-off 332OS, supporto doccia presa acqua su piastra in ottone e flessibile cm 120.

Built-in shut-off mixer set SQ3 series including: shut-off 332OS, shower holder water punch on flange, all in brass and flexible hose cm 120.

CR



Z60

Miscelatore incasso shut-off serie Flash comprensivo di: doccetta shut-off 332OS, supporto doccia presa acqua su piastra in ottone e flessibile cm 120.

Built-in shut-off mixer set Flash series including: shut-off 332OS, shower holder water punch on flange, all in brass and flexible hose cm 120.

CR



Q60

Miscelatore incasso shut-off serie Qubika comprensivo di: doccetta shut-off 332OS, supporto doccia presa acqua su piastra in ottone e flessibile cm 120.

Built-in shut-off mixer set Qubika series including: shut-off 332OS, shower holder water punch on flange, all in brass and flexible hose cm 120.

CR



W65

Miscelatore incasso per shut-off serie Winner comprensivo di doccetta shut-off 332OL, supporto doccia-presa acqua, attacco conico da 1/2" e supporto shut-off, tutto in ottone, flessibile cm 120.

Built-in shower mixer set Winner series including: shut-off 332OL, shower holder water punch on flange, all in brass, with 1/2 connection, handshower support and flexible hose cm 120.

CR



W65W

Miscelatore incasso per shut-off serie Winner comprensivo di doccetta shut-off 332OW, supporto doccia-presa acqua, attacco conico da 1/2" e supporto shut-off, tutto in ottone, flessibile cm 120.

Built-in shower mixer set Winner series including: shut-off 332OW, shower holder water punch on flange, all in brass, with 1/2 connection, handshower support and flexible hose cm 120.

CR



W65B

Miscelatore incasso per shut-off serie Winner su piastra in ottone, attacco conico da 1/2" e supporto shut-off.

Built-in shut-off mixer Winner series all in brass with 1/2 connection and handshower support.

CR



I65

Miscelatore incasso shut-off serie Infinity comprensivo di doccetta shut-off 332OL, supporto doccia-presa acqua, attacco conico da 1/2" e supporto shut-off, tutto in ottone, flessibile cm 120.

Built-in shower mixer set Infinity series including: shut-off 332OL, shower holder water punch on flange, all in brass, with 1/2 connection, handshower support and flexible hose cm 120.

CR



I65W

Miscelatore incasso shut-off serie Infinity comprensivo di doccetta shut-off 332OW, supporto doccia-presa acqua, attacco conico da 1/2" e supporto shut-off, tutto in ottone, flessibile cm 120.

Built-in shower mixer set Infinity series including: shut-off 332OW, shower holder water punch on flange, all in brass, with 1/2 connection, handshower support and flexible hose cm 120.

CR



I65B

Miscelatore incasso per shut-off serie Infinity su piastra in ottone, attacco conico da 1/2" e supporto shut-off.

Built-in shut-off mixer Infinity series all in brass with 1/2 connection and handshower support.

CR

SHUT-OFF

PLACCHE WC
TOILET PLATES

LAVABO
WASHBASIN

LOUNGE

FLAT

GUEST

SUITE

EPOCA

ACCESSORI
ACCESSORIES

IDROSCOPINI
HYDRO-BRUSH

COMPLEMENTI
COMPL. ITEMS

RICAMBI
SPARE PARTS

SHUT-OFF



L65

Miscelatore incasso shut-off serie Class Line comprensivo di doccetta shut-off 332OL, supporto doccia-presa acqua, attacco conico da 1/2" e supporto shut-off, tutto in ottone, flessibile cm 120.
Built-in shower mixer set Class Line series including: shut-off 332OL, shower holder water punch on flange, all in brass, with 1/2 connection, handshower support and flexible hose cm 120.

CR



L65W

Miscelatore incasso shut-off serie Class Line comprensivo di doccetta shut-off 332OW, supporto doccia-presa acqua, attacco conico da 1/2" e supporto shut-off, tutto in ottone, flessibile cm 120.

Built-in shower mixer set Class Line series including: shut-off 332OW, shower holder water punch on flange, all in brass, with 1/2 connection, handshower support and flexible hose cm 120.

CR



L65B

Miscelatore incasso per shut-off serie Class Line su piastra in ottone, attacco conico da 1/2" e supporto shut-off.

Built-in shut-off mixer Class Line series all in brass with 1/2 connection and handshower support.

CR



D65

Miscelatore incasso shut-off serie Dream comprensivo di doccetta shut-off 332OL, supporto doccia-presa acqua, attacco conico da 1/2" e supporto shut-off, tutto in ottone, flessibile doccia cm 120.

Built-in shower mixer set Dream series including: shut-off 332OL, shower holder water punch on flange, all in brass, with 1/2 connection, handshower support and flexible hose cm 120.

CR



D65W

Miscelatore incasso shut-off serie Dream comprensivo di doccetta shut-off 332OW, supporto doccia-presa acqua, attacco conico da 1/2" e supporto shut-off, tutto in ottone, flessibile doccia cm 120.

Built-in shower mixer Dream series set including: shut-off 332OW, shower holder water punch on flange, all in brass, with 1/2 connection, handshower support and flexible hose cm 120.

CR



D65B

Miscelatore incasso per shut-off serie Dream su piastra in ottone, attacco conico da 1/2" e supporto shut-off.

Built-in shut-off mixer Dream series all in brass with 1/2 connection and handshower support.

CR



N65

Miscelatore incasso shut-off serie Minimal comprensivo di doccetta shut-off 332OL, supporto doccia presa acqua, attacco conico da 1/2" e supporto shut-off, tutto in ottone, flessibile cm 120.
Built-in shower mixer set Minimal series including shut-off 332OL, shower holder water punch on flange, all in brass, with 1/2 connection, handshower support and flexible hose cm 120.

CR



N65W

Miscelatore incasso shut-off serie Minimal comprensivo di doccetta shut-off 332OW, supporto doccia-presa acqua, attacco conico da 1/2" e supporto shut-off, tutto in ottone, flessibile doccia cm 120.

Built-in shower mixer set Minimal series including: shut-off 332OW, shower holder water punch on flange, all in brass, with 1/2 connection, handshower support and flexible hose cm 120.

CR



N65B

Miscelatore incasso per shut-off serie Minimal su piastra in ottone, attacco conico da 1/2" e supporto shut-off.

Built-in shut-off mixer Minimal series all in brass with 1/2 connection and handshower support.

CR



N65SW

Miscelatore incasso shut-off serie Minimal con leva corta, comprensivo di doccetta shut-off 332OW, supporto doccia-presa acqua, attacco conico da 1/2" e supporto shut-off, tutto in ottone, flessibile cm 120.

Built-in shower mixer Minimal series set with short lever, including: shut-off 332OW, shower holder water punch on flange, all in brass, with 1/2 connection, handshower support and flexible hose cm 120.

CR



X65W

Miscelatore incasso shut-off serie X Style comprensivo di doccetta shut-off 332OW, supporto doccia-presa acqua, attacco conico da 1/2" e supporto shut-off, tutto in ottone, flessibile cm 120.

Built-in shower mixer X Style series set including: shut-off 332OW, shower holder water punch on flange, all in brass, with 1/2 connection, handshower support and flexible hose cm 120.

CR



X65B

Miscelatore incasso per shut-off serie X Style su piastra in ottone, attacco conico da 1/2" e supporto shut-off.

Built-in shut-off mixer X Style series all in brass with 1/2 connection and handshower support.

CR



V65W

Miscelatore incasso shut-off serie Vanity comprensivo di doccetta shut-off 332OW, supporto doccia-presa acqua, attacco conico da 1/2" e supporto shut-off, tutto in ottone, flessibile cm 120.

Built-in shower mixer Vanity series set including: shut-off 332OW, shower holder water punch on flange, all in brass, with 1/2 connection, handshower support and flexible hose cm 120.

CR



V65B

Miscelatore incasso per shut-off serie Vanity su piastra in ottone, attacco conico da 1/2" e supporto shut-off.

Built-in shut-off mixer Vanity series all in brass with 1/2 connection and handshower support.

CR



Q65

Miscelatore incasso shut-off serie Qubika comprensivo di doccetta shut-off 332OS, supporto doccia-presa acqua, attacco conico da 1/2" e supporto shut-off, tutto in ottone, flessibile cm 120.

Built-in shower mixer Qubika series set including: shut-off 332OS, shower holder water punch on flange, all in brass, with 1/2 connection, handshower support and flexible hose cm 120.

CR



Q65B

Miscelatore incasso per shut-off serie Qubika su piastra in ottone, attacco conico da 1/2" e supporto shut-off.

Built-in shut-off mixer Qubika series all in brass with 1/2 connection and handshower support.

CR

**SHUT-OFF TERMOSTATICO
THERMOSTATIC SHUT-OFF**



NT60W

Miscelatore incasso per shut-off serie Minimal Thermo comprensivo di: doccetta shut-off 332OW, supporto doccia presa acqua su piastra in ottone e flessibile cm 120.

Built-in shut-off mixer set Minimal Thermo series including: shut-off 332OW, shower holder water punch on flange, all in brass and flexible hose cm 120.

CR

SHUT-OFF

PLACCHE WC
TOILET PLATES

LAVABO
WASHBASIN

LOUNGE

FLAT

GUEST

SUITE

EPOCA

ACCESSORI
ACCESSORIES

IDROSCOPINI
HYDRO-BRUSH

COMPLEMENTI
COMPL. ITEMS

RICAMBI
SPARE PARTS

MISCELATORI CON DEVIAZIONE INTEGRATA PER SHUT-OFF MIXERS WITH INTEGRATED DIVERTER FOR SHUT-OFF



L10SHW

Miscelatore monocomando lavabo serie Class Line con doccetta shut-off 332OW e scarico click-clack con troppo pieno.

Single-lever basin mixer Class Line series with handshower shut-off 332OW and click-clack waste with overflow.

CR

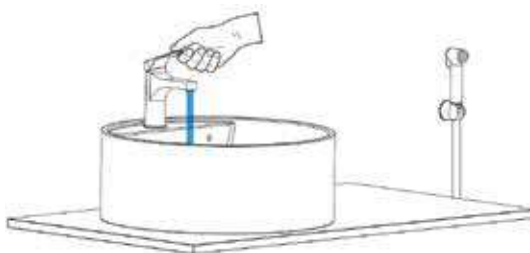

1

ALZANDO LA LEVA AZIONIAMO IL FLUSSO D'ACQUA DEL MISCELATORE.
BY LIFTING THE LEVER WE OPEN THE WATER FLOW OF THE MIXER.



2

SCHIACCIANDO IL PULSANTE DEVIAMO IL FLUSSO D'ACQUA ALLA DOCCETTA.
BY PUSHING THE BUTTON WE DIVERT THE WATER FLOWING TO THE HAND SHOWER.

MISCELATORI SHUT-OFF CONN INTERASSE 100MM SHUT-OFF MIXERS WITH INTERAXIS 100MM



LC31DP

Miscelatore monocomando esterno doccia serie Class Line, interasse 100 mm, con kit composto da doccetta shut-off in ABS cromato 332DPCR, flessibile conico in ottone 120 cm e gancio cromato 332GA.

Wall mounted single lever shower mixer Class Line series, interaxis 100 mm with kit including: shut-off handshower in c.p. ABS 332DPCR, conical flexible hose in brass cm 120 and c.p. hook 332GA.

CR



IC31REW

Miscelatore monocomando esterno doccia serie Infinity, interasse 100 mm, con kit composto da doccia a pulsante 332OW, flessibile conico 120 cm e supporto 339SO in ottone.

Wall mounted single lever shower mixer Infinity series, interaxis 100 mm, with kit including: shut-off handshower 332OW, conical flexible hose cm 120 and shower holder 339SO.

CR



WC31DP

Miscelatore monocomando esterno doccia serie Winner, interasse 100 mm, con kit composto da doccetta shut-off in ABS cromato 332DPCR, flessibile conico in ottone 120 cm e gancio cromato 332GA.

Wall mounted single lever shower mixer Winner series, interaxis 100 mm, with kit composed of shut-off handshower in c.p. ABS 332DPCR, conical flexible hose in brass cm 120 and c.p. hook 332GA.

CR

LC31

Miscelatore monocomando esterno doccia serie Class Line, interasse 100 mm, senza kit doccia.
Wall mounted single lever shower mixer Class Line series, interaxis 100 mm without shower set.

CR

IC31

Miscelatore monocomando esterno doccia serie Infinity, interasse 100 mm, senza kit doccia.
Wall mounted single lever shower mixer Infinity series, interaxis 100 mm without shower set.

CR

WC31

Miscelatore monocomando esterno doccia serie Winner, interasse 100 mm, senza kit doccia.
Wall mounted single lever shower mixer Winner series, interaxis 100 mm without shower set.

CR



C332REL

Set "Relax" composto da: doccia a pulsante 332OL, flessibile conico 120 cm, miscelatore doccia serie Cento C33 interasse 100 mm e supporto "lux" in ottone.

"Relax" set including: shut-off handshower 332OL, conical flexible hose cm 120, shower mixer serie Cento C33 interaxis 100 mm and brass "Lux" shower holder.

CR



C332REZ

Set "Relax" composto da: doccia a pulsante 332OZ, flessibile conico 120 cm, miscelatore doccia serie Cento C33 interasse 100 mm e supporto "lux" in ottone.

"Relax" set including: shut-off handshower 332OZ, conical flexible hose cm 120, shower mixer serie Cento C33 interaxis 100 mm and brass "Lux" shower holder.

CR



C332RELA

Set "Relax" composto da: doccia a pulsante 332OLA, flessibile conico 120 cm, miscelatore doccia serie Cento C33 interasse 100 mm e supporto "lux" in ottone.

"Relax" set including: shut-off handshower 332OLA, conical flexible hose cm 120, shower mixer serie Cento C33 interaxis 100 mm and brass "Lux" shower holder.

CR



C332DP

Esterno doccia con leva frontale, interasse 100 mm, doccetta shut-off in ABS cromato e flessibile da 120 cm.

Wall mounted single-lever shower mixer, interaxis 100 mm, with frontal lever, with handshower shut-off in c.p. ABS and flexible hose 120 cm.

CR



C312DP

Esterno doccia, interasse 100 mm, doccetta shut-off in ABS cromato e flessibile da 120 cm.

Wall mounted single-lever shower mixer interaxis 100 mm, with handshower shut-off in c.p. ABS and flexible hose 120 cm.

CR



C312REL

Esterno doccia, interasse 100 mm, doccetta shut-off in ottone e flessibile da 120 cm.

Wall mounted single-lever shower mixer interaxis 100 mm, with handshower shut-off in brass and flexible hose 120 cm.

CR



C312RELA

Esterno doccia, interasse 100 mm, doccetta shut-off in ottone e flessibile da 120 cm.

Wall mounted single-lever shower mixer interaxis 100 mm, with handshower shut-off in brass and flexible hose 120 cm.

CR

SHUT-OFF MONOACQUA - SINGLE WATER SHUT-OFF

**332REL336**

Set composto da: doccia a pulsante 332OL, flessibile con attacco conico cm 120, rubinetto d'arresto con supporto doccia in ottone.

Set including: shut-off handshower 332OL, flexible hose cm 120, brass round angle valve with shower holder.

CR

**332RES336**

Set composto da: doccia a pulsante quadrata 332OS, flessibile con attacco conico cm 120, rubinetto d'arresto con supporto doccia in ottone.

Set including: shut-off handshower 332OS, flexible hose cm 120, brass squared angle valve with shower holder.

CR

**332REW336**

Set quadrato composto da: doccia a pulsante 332OW, flessibile con attacco conico cm 120, rubinetto d'arresto con supporto doccia in ottone.

Squared set including: shut-off handshower 332OW, flexible hose cm 120, brass round angle valve with shower holder.

CR

**332RELA336**

Set composto da: doccia a pulsante 332OLA (compreso di aeratore e chiave 83AC), flessibile con attacco conico cm 120, rubinetto d'arresto con supporto doccia in ottone.

Set including: shut-off handshower 332OLA (complete of aerator and key kit 83AC), flexible hose cm 120, brass squared angle valve with shower holder.

CR

**332REZ336**

Set composto da: doccia a pulsante con impugnatura zigrinata 1/2" 332OZ, flessibile con attacco conico cm 120, rubinetto d'arresto, con supporto doccia in ottone.

Set including: shut-off handshower with knurled handgrip 1/2" 332OZ, flexible hose cm 120, brass round angle valve with shower holder.

CR

**332REU336**

Set composto da: doccia a pulsante minimale in ABS cromata 332EU, flessibile con attacco conico cm 120, rubinetto d'arresto, con supporto doccia in ottone.

Set including: shut-off ABS minimal handshower 332EU, flexible hose cm 120, brass squared angle valve with shower holder.

CR

**332REL129**

Set "Relax" composto da: doccia a pulsante 332OL, flessibile conico 120 cm, rubinetto sottolavabo art. 129 e supporto "Lux" in ottone.

"Relax" set including: shut-off handshower 332OL, conical flexible hose 120 cm, angle valve art. 129 and "Lux" brass shower holder.

CR

**332REZ129**

Set "Relax" composto da: doccia a pulsante 332OZ, flessibile conico 120 cm, rubinetto sottolavabo art. 129 e supporto "Lux" in ottone.

"Relax" set including: shut-off handshower 332OZ, conical flexible hose 120 cm, angle valve art. 129 and "Lux" brass shower holder.

CR



338M332OL

Set composto da: doccetta a pulsante, flessibile con attacco conico cm 120, rubinetto ad angolo Minimal con vitone ceramico e supporto doccia "Lux" in ottone.
 Set composed of: shut-off handshower, cm 120 flexible hose with one conical nut, angle valve serie "Minimal" with ceramic headwork and "Lux" brass shower holder.

CR



338M332OW

Set composto da: doccetta a pulsante, flessibile con attacco conico cm 120, rubinetto ad angolo Minimal con vitone ceramico e supporto doccia "Lux" in ottone.
 Set composed of: shut-off handshower, cm 120 flexible hose with one conical nut, angle valve serie "Minimal" with ceramic headwork and "Lux" brass shower holder.

CR

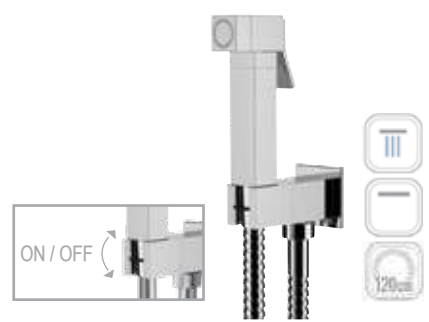

338Q332OS

Set composto da: doccetta a pulsante, flessibile con attacco conico cm 120, rubinetto ad angolo SQ con vitone ceramico e supporto doccia "Lux" in ottone.
 Set composed of: shut-off handshower, cm 120 flexible hose with one conical nut, angle valve serie "SQ" with ceramic headwork and "Lux" brass shower holder.

CR



332RELA

Set "Relax", composto da: doccia a pulsante 332OLA (compresa di aeratore e chiave 83AC), flessibile conico 120 cm, supporto "Lux" in ottone, con rubinetto sottolavabo "Minimal" e vitone ceramico.

"Relax" set including: shut-off handshower 332OLS (complete of aerator and key kit 83AC), conical flexible hose 120 cm, "Lux" brass shower holder, with "Minimal" angle valve and ceramic headwork.

CR



332REZ

Set "Relax", composto da: doccia a pulsante 332OZ, flessibile conico 120 cm, supporto "Lux" in ottone, con rubinetto sottolavabo "Minimal" e vitone ceramico.

"Relax" set including: shut-off handshower 332OZ, conical flexible hose cm, "Lux" brass shower holder, with "Minimal" angle valve and ceramic headwork.

CR



332RES

Set "Relax SQ" composto da: doccia quadrata a pulsante 332OS, flessibile conico 120 cm, supporto "Lux" in ottone, con rubinetto sottolavabo "SQ" con vitone ceramico.

"Relax SQ" set, including: "SQ" shut-off handshower 332OS, conical flexible hose 120 cm, "Lux" brass shower holder, with "SQ" angle valve with ceramic headwork.

CR

332332OLA
 senza rubinetto sottolavabo.
 without angle valve.

CR

332332OZ
 senza rubinetto sottolavabo.
 without angle valve.

CR

332332OS
 senza rubinetto sottolavabo.
 without angle valve.

CR

SHUT-OFF

PLACCHE WC
 TOILET PLATES

LAVABO
 WASHBASIN

LOUNGE

FLAT

GUEST

SUITE

EPOCA

ACCESSORI
 ACCESSORIES

IDROSCOPINI
 HYDRO-BRUSH

COMPLEMENTI
 COMPL. ITEMS

RICAMBI
 SPARE PARTS

SHUT-OFF



332EURM

Set "Eurolux" composto da: doccia a pulsante minimale in ABS cromata 332EU, flessibile conico metallizzato 120 cm, supporto in ABS, con rubinetto sottolavabo Minimal con vitone ceramico.

"Eurolux" set including: shut-off handshower minimal in c.p. ABS 332EU, conical metallized flexible hose cm 120, ABS shower holder, with Minimal angle valve with ceramic headvalve.

CR

332332EUM

senza rubinetto sottolavabo.
without angle valve.

CR



332REL

Set "Relax", composto da: doccia a pulsante 332OL, flessibile conico 120 cm, supporto "Lux" in ottone, con rubinetto sottolavabo Minimal con vitone ceramico.

"Relax" set including: shut-off handshower 332OL, conical flexible hose 120 cm, "Lux" brass shower holder, with Minimal angle valve with ceramic headvalve.

CR

332332OL

senza rubinetto sottolavabo.
without angle valve.

CR



332REW

Set "Relax", composto da: doccia a pulsante 332OW, flessibile conico 120 cm, supporto "Lux" in ottone, con rubinetto sottolavabo Minimal in ottone con vitone ceramico.

"Relax" set including: shut-off handshower 332OW, conical flexible hose 120 cm, "Lux" brass shower holder, with angle valve in brass serie Minimal and with ceramic headwork.

CR

332332OW

senza rubinetto sottolavabo.
without angle valve.

CR



332RERCR

doccia a pulsante cromata 332ORCR, flessibile conico 120 cm e supporto cromato 339 F, con rubinetto sottolavabo in ottone.

chrome plastic shut-off handshower 332ORCR, conical flexible hose cm 120, and chrome shower support 339 F, with angle valve in brass.

CR

332332ORCR

senza rubinetto sottolavabo.
without angle valve.

CR



332DPRR

Set "Eco" composto da: doccia a pulsante bianca 332DPR, flessibile retinato 120 cm e gancio bianco 332GA, con rubinetto sottolavabo in ottone.

"Eco" set including: white plastic shut-off handshower 332DPR, net worked flexible hose cm 120 and white hook 332GA, with angle valve in brass.

CR

33212

senza rubinetto sottolavabo.
without angle valve.

CR



332DCR

Set "Eco" composto da: doccia a pulsante cromata 332DPCR, flessibile cromato 120 cm e gancio cromato 332GA, con rubinetto sottolavabo in ottone.

"Eco" set including: c.p. plastic shut-off handshower 332DPCR, conical brass flexible hose cm 120 and c.p. hook 332GA, with angle valve in brass.

CR

332332DCR

senza rubinetto sottolavabo.
without angle valve.

CR



332RER

Set composto da: doccia a pulsante bianca 332 OR, flessibile retinato 120 cm e supporto bianco 339 F BI, con rubinetto sottolavabo in ottone.
 Set including: white plastic shut-off handshower 332 OR, net worked flexible hose cm 120 and white shower support 339 F BI, with angle valve in brass.

CR



332TEL

Set composto da: doccia a pulsante, flessibile conico 120 cm, rubinetto temporizzato 1/2" in ottone tempo di apertura 6-8 secondi.
 Set including: shut-off handshower, flexible cm 120, temporized button flusher 1/2" all in Brass, opening time 6-8 seconds.

CR



332RGRR

Set composto da flessibile retinato bianco cm 120, rompigitto con gancio, appendino, rubinetto sottolavabo.
 Set including: shower flexible in white net working cm 120, jet breaker with holder, hook, angle valve.

CR

332332OR

senza rubinetto sottolavabo.
 without angle valve.

CR



332RGRE120

Set composto da flessibile retinato bianco cm 120, rompigitto con gancio, appendino.
 Set including: white shower flexible hose net working cm 120, jet breaker with shower holder, hook.

CR



332RG

Rompigitto in ABS cromato con anello per attacco a muro.
 C.p. ABS flow regulator with ring for wall connection.

CR



81RD12

Riduzione 1/2MxM22 di collegamento flessibile doccia con aeratore F22 (nostro art. 81).
 Reduction 1/2MxM22 to connect the shower flexible to F22 aerator (our article 81).

CR



332GA

Appendino in ABS cromato.
 C.p. ABS hook.

CR



332GABI

Appendino in ABS bianco.
 White ABS hook.

CR



81

Aeratore classico con retine in inox, per gruppo lavello F22.
 Classic aerator with inox nets, for sink spout F22.

CR

SHUT-OFF

PLACCHE WC
TOILET PLATES

LAVABO
WASHBASIN

LOUNGE

FLAT

GUEST

SUITE

EPOCA

ACCESSORI
ACCESSORIES

IDROSCOPINI
HYDRO-BRUSH

COMPLEMENTI
COMPL. ITEMS

RICAMBI
SPARE PARTS

DOCCETTE SHUT-OFF IN OTTONE - SHUT-OFF HANDSHOWER IN BRASS



Doccetta a pulsante quadrata, in ottone, 1/2".
Brass squared shut-off, with plain handgrip, 1/2"

332OS

Senza scatola - Without box

CR

**332OSX**

Con scatola - With box

CR



Doccetta a pulsante "Lux" in ottone, con impugnatura liscia 1/2".
Brass shut-off "Lux" handshower with plain handgrip, 1/2".

332OL

Senza scatola - Without box

CR

**332OLX**

Con scatola - With box

CR



Doccetta a pulsante "Lux" in ottone, con impugnatura zigrinata 1/2".
Brass shut-off "Lux" handshower with knurled handgrip, 1/2".

332OZ

Senza scatola - Without box

CR

**332OZX**

Con scatola - With box

CR



Doccetta a pulsante "Lux" in ottone, con impugnatura bombata 1/2".
Brass shut-off "Lux" handshower with convex handgrip, 1/2".

332OB

Senza scatola - Without box

CR

**332OBX**

Con scatola - With box

CR

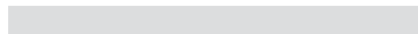

Doccetta a pulsante "Lux" in ottone, con impugnatura liscia da 1/2" completa di kit aeratore con chiave 83AC, nuovo sistema brevettato ad alta tecnologia per la pulizia dell'aeratore e di lunghissima durata.
Brass shut-off "Lux" handshower, with plain handgrip, 1/2" complete with aerator and key kit 83AC, new Patented system of high technology for the cleaning of the aerator, extremely long lasting.

332OLA

Senza scatola - Without box

CR

**332OLAX**

Con scatola - With box

CR

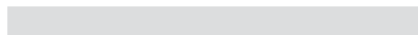

Doccetta a pulsante "Lux" minimale in ottone, con impugnatura liscia 1/2".
Minimal Brass shut-off "Lux" handshower with plain handgrip, 1/2".

332OW

Senza scatola - Without box

CR

**332OWX**

Con scatola - With box

CR

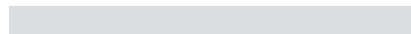

DOCLETTE SHUT-OFF IN ABS - SHUT-OFF HANDSHOWER IN ABS



332DPCR
Doccetta a pulsante, 1/2 cromata.
C.P. shut-off, 1/2.

CR



332DPBN
Doccetta a pulsante, 1/2 bianca.
White shut-off, 1/2.

CR



332ORCR
Doccetta shut-off cromata in ABS stampata made in italy.
Chrome ABS shut off handshower printed made in italy.

CR



332LUCR
Doccetta a pulsante, 1/2 cromata.
C.P. shut-off, 1/2

CR



332OR
Doccetta shut-off bianca in ABS stampata made in italy.
White ABS shut off handshower printed made in italy.

CR



332ORNE
Doccetta shut-off nera in ABS stampata made in italy.
Black ABS shut off handshower printed made in italy.

CR



Doccetta a pulsante minimale in ABS cromata con impugnatura liscia, 1/2".
C.p. ABS minimal shut-off, with plain handgrip, 1/2".

332EU Senza scatola - Without box
CR

332EUX Con scatola - With box
CR

SHUT-OFF

PLACCHE WC
TOILET PLATES

LAVABO
WASHBASIN

LOUNGE

FLAT

GUEST

SUITE

EPOCA

ACCESSORI
ACCESSORIES

IDROSCOPINI
HYDRO-BRUSH

COMPLEMENTI
COMPL. ITEMS

RICAMBI
SPARE PARTS

PLACCHE WC TOILET PLATES



RB810CR

Scopri la nostra gamma di placche WC, progettate per unire estetica e praticità. Offriamo due forme distintive: quadrata e tonda, per adattarsi perfettamente a qualsiasi bagno.

Discover our range of WC plates designed to combine aesthetics and practicality. We offer two distinctive shapes: square and round, perfectly suited for any bathroom.

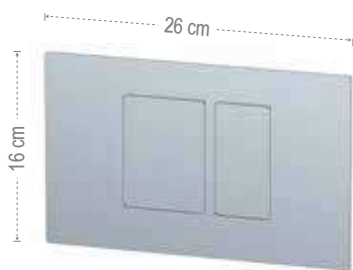

RB820CR

Piastra WC con pulsanti rettangolari.
Toilet flush plate with rectangular buttons.



RB810CR

Piastra WC con pulsanti tondi.
Toilet flush plate with rounded buttons.



COMPATIBILITÀ CON : - COMPATIBILITY WITH :

Geberit	Tece	Viega	Oil
SIGMA 8 CM SIGMA 12 CM	2003-2020 2021-NOW	3H - 3L - 3F	74 PLUS 120 PLUS EXPERT PLUS QUADRA PLUS



NO



RB820NO
Nero opaco
Matt black



RB810NO
Nero opaco
Matt black

BO



RB820BO
Bianco opaco
Matt white



RB810BO
Bianco opaco
Matt white

INOX



SSRB820
Visual inox
Visual steel



SSRB810
Visual inox
Visual steel



BG



RB820BG
Oro Spazzolato
Brushed Gold



RB810BG
Oro Spazzolato
Brushed Gold

DO



RB820DO
Oro Lucido
Shiny Gold



RB810DO
Oro Lucido
Shiny Gold

LAVABO WASHBASIN



RB902BG

Con linee essenziali e materiali di alta qualità, questo lavabo è disponibile in varie finiture, perfetto per chi desidera uno stile elegante e pratico in bagno.

With clean lines and high-quality materials, this sink is available in various finishes, perfect for those who desire both elegance and practicality in the bathroom.



RB902DO
Oro Lucido
Shiny Gold



RB902BG
Oro Spazzolato
Brushed Gold



RB902CFP
Cromo Nero Spazzolato
Brushed Black Chrome



RB902RP
Rame Spazzolato
Brushed Copper

FIN 2



RB902CR

Lavabo da appoggio rotondo, con ceramica bianca e fascia in finitura a scelta.
Round countertop washbasin with white ceramic and band in your choice of finish.

CR



NO



INOX



FIN 2

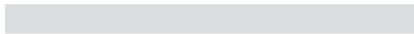

RB902NO

Nero opaco
Matt black

NO



SSRB902

Visual inox
Visual steel

INOX



RB902RP

LOUNGE



LN13CR



LN13CR
Dispenser per sapone liquido in vetro satinato con supporto in ottone.
Satin glass soap dispenser with cp brass support.

CR



LN15CR
Portabicchiere in ottone con bicchiere in vetro satinato.
Cp brass cup holder with satin glass.

CR



LN10CR
Portasapone in vetro satinato con supporto in ottone.
Satin glass soap dish holder with cp brass support.

CR



LN50CR
Appendino in ottone.
Cp brass hook.

CR



LN44CR
Portasalviette in ottone, 23,6x70 mm.
Cp brass towel holder 23,6x70 mm.

CR



LN60CR
Portarotolo in ottone.
Cp brass toilet paper holder.

CR



LN61CR
Portarotolo di ricambio in ottone.
Brass spare toilet paper holder.

CR

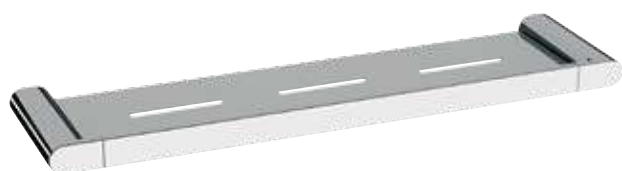

LN20CR

Mensola in ottone, dimensione 13x51 cm.
Cp brass shelf, dimensions 13x51 cm.

CR



LN33CR

Portasalviette doppio in ottone, lunghezza cm 60.
Cp brass double towel holder, length cm 60.

CR



LN30CR

Portasalviette in ottone, lunghezza cm 60.
Cp brass towel holder, length cm 60.

CR



LN40CR

Portasalviette in ottone, lunghezza cm 40.
Cp brass towel holder, length cm 40.

CR

RICAMBI - SPARE PARTS



ACGL10VG

Portasapone in vetro satinato.
Satin glass soap holder.

CR



ACGL13LN

Dispenser in vetro satinato.
Satin glass dispenser.

CR



ACGL15VG

Bicchiere in vetro satinato.
Satin glass cup.

CR

FLAT



FT20CR



FT13CR
Dispenser per sapone liquido in ceramica con supporto in ottone.
Ceramic soap dispenser with cp brass support.

CR



FT15CR
Portabicchiere in ottone con bicchiere in ceramica.
Cp brass cup holder with ceramic glass.

CR



FT10CR
Portasapone in ceramica con supporto in ottone.
Ceramic soap dish holder with cp brass support.

CR



FT66CR
Portascopino in ceramica con supporto in ottone.
Ceramic broom rack holder with cp brass support.

CR



FT60CR
Portarotolo in ottone.
Cp brass toilet paper holder.

CR



FT61CR
Portarotolo di ricambio in ottone.
Cp brass spare toilet paper holder.

CR



FT50CR
 Appendino in ottone.
Cp brass hook.

CR



FT44CR
 Portasalviette ad anello in ottone.
Cp brass towel ring.

CR



FT36CR
 Portasciugamano a braccia girevoli in ottone, lunghezza cm 45.
Cp brass multiple bar towel holder with swivelling bars, length cm 45.

CR



FT20CR
 Mensola in vetro con supporti in ottone, dimensione 12x52 cm.
Glass shelf with cp brass support, dimensions 12x52 cm.

CR



FT40CR
 Portasalviette in ottone, lunghezza cm 40.
Cp brass towel holder, length cm 40.

CR



FT30CR
 Portasalviette in ottone, lunghezza cm 60.
Cp brass towel holder, length cm 60.

CR



FT33CR
 Portasalviette doppio in ottone, lunghezza cm 60.
Cp brass double towel holder, length cm 60.

CR



FTSET8PCR

Set serie FLAT composto da 8 accessori:

- 2 portasapone
- 1 portabicchiere
- 1 portasalviette cm 60
- 1 portasalviette cm 40
- 1 portasalviette ad anello
- 1 appendino
- 1 portarotolo

Set FILAT serie composta di 8 accessori:

- 2 soap dish holders
- 1 cup holder
- 1 towel holder cm 60
- 1 towel holder cm 40
- 1 towel ring
- 1 hook
- 1 toilet paper roll holder

RICAMBI - SPARE PARTS



AC66WI
 Scopino da bagno.
Toilet brush.

CR



ACCE10
 Portasapone in ceramica.
Ceramic soap holder.

CR



ACCE13WI
 Dispenser in ceramica.
Ceramic dispenser.

CR



ACCE15
 Bicchiere in ceramica.
Ceramic cup.

CR

GUEST



GS50CR - GS13CR

GUEST OPZIONI DI FINITURA

Questa collezione di rubinetteria è disponibile con diverse opzioni di finitura, scegli il colore perfetto per il tuo progetto di arredo!
Rispondendo alle esigenze stilistiche dei progetti più ambiziosi, Remer Rubinetterie ha selezionato 7 colori, oltre al cromato, studiati per arricchire, personalizzare e differenziare gli interni di bagno e cucina.

[Per confermare la propria scelta, aggiungere il codice della finitura al termine del codice prodotto durante la fase di acquisto.]

GUEST FINISHING OPTIONS

This faucet collection is available with different finishing options, choose the perfect color to customize your interior!
Responding to the stylistic needs of the most ambitious designs, Remer Rubinetterie selected 7 colors, in addition to chrome, to enrich, customize and differentiate bathroom and kitchen interiors.

[To confirm your choice, add the finishing code at the end of the item code during the purchase phase.]

CR	FIN 1	FIN 2
 cromo chrome CR	 nero opaco matt black NO  bianco opaco matt white BO  nichel spazzolato brushed nickel NP  visual inox visual steel XV	 cromo nero spazzolato brushed black chrome CFP  oro spazzolato brushed gold BG  oro lucido shiny gold DO



GS13CR

Dispenser per sapone liquido in ceramica con supporto in ottone.
Ceramic soap dispenser with brass support.

CR FIN 1 FIN 2



GS15CR

Portabicchiere in ottone con bicchiere in ceramica.
Brass cup holder with ceramic glass.

CR FIN 1 FIN 2



GS60CR

Portarotolo in ottone.
Cp brass toilet paper holder.

CR FIN 1 FIN 2



GS44CR

Portasalviette ad anello in ottone.
Brass towel ring.

CR FIN 1 FIN 2



GS10CR

Portasapone in ceramica con supporto in ottone.
Ceramic soap dish holder with brass support.

CR FIN 1 FIN 2



GS11CR

Portasapone in ottone.
Brass soap holder.

CR FIN 1 FIN 2



GS62CR

Portarotolo di ricambio in ottone.
Brass spare toilet paper holder.

CR FIN 1 FIN 2



GS61CR

Portarotolo di ricambio in ottone.
Brass spare toilet paper holder.

CR FIN 1 FIN 2



GS66CR

Portascopino in ceramica con supporto in ottone.
Ceramic broom rack holder with brass support.

CR FIN 1 FIN 2



GS50CR

Appendino in ottone.
Brass hook.

CR FIN 1 FIN 2



GS20CR
Mensola in vetro con supporti in ottone.
Glass shelf with brass support.

CR FIN 1 FIN 2

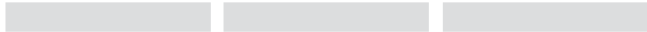

GS33CR
Portasalviette doppio in ottone, lunghezza cm 60.
Brass double towel holder, length cm 60.

CR FIN 1 FIN 2

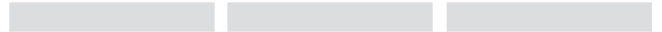

GS30CR
Portasalviette in ottone, lunghezza cm 60.
Brass towel holder, length cm 60.

CR FIN 1 FIN 2

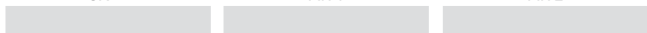

GS40CR
Portasalviette in ottone, lunghezza cm 40.
Brass towel holder, length cm 40.

CR FIN 1 FIN 2

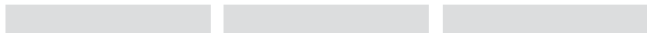

GSSET8PCR

Set serie GUEST composto da 8 accessori:

Set GUEST serie composed of 8 accessories:

- 2 portasapone
- 1 portabicchiere
- 1 portasalviette cm 60
- 1 portasalviette cm 40
- 1 portasalviette ad anello
- 1 appendino
- 1 portarotolo
- 2 soap dish holders
- 1 cup holder
- 1 towel holder cm 60
- 1 towel holder cm 40
- 1 towel ring
- 1 hook
- 1 toilet paper roll holder

CR FIN 1 FIN 2

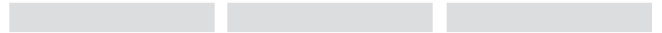

RICAMBI - SPARE PARTS



AC66AR
Scopino da bagno.
Toilet brush.

CR

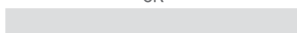

ACCE10
Portasapone in ceramica.
Ceramic soap holder.

CR

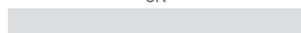

ACCE13WI
Dispenser in ceramica.
Ceramic soap dispenser.

CR

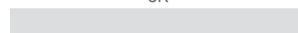

ACCE15
Bicchiere in ceramica.
Ceramic glass.

CR

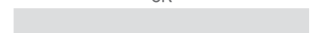



GS20CR

SHUT-OFF

PLACCHE WC
TOILET PLATES

LAVABO
WASHBASIN

LOUNGE

FLAT

GUEST

SUITE

EPOCA

ACCESSORI
ACCESSORIES

IDROSCOPINI
HYDRO-BRUSH

COMPLEMENTI
COMPL. ITEMS

RICAMBI
SPARE PARTS

SUITE



SU10CR



SU13CR
Dispenser per sapone liquido in vetro satinato con supporto in ottone.
Satin glass soap dispenser with brass support.

CR



SU15CR
Portabicchiere in ottone con bicchiere in vetro satinato.
Brass cup holder with satin glass.

CR



SU10CR
Portasapone in vetro satinato con supporto in ottone.
Satin glass soap dish holder with brass support.

CR



SU44CR
Portasalviette ad anello in ottone.
Brass towel ring.

CR



SU60CR
Portarotolo in ottone.
Brass toilet paper holder.

CR



SU50CR
Appendino in ottone.
Brass hook.

CR



SU62CR
Portarotolo di ricambio in ottone.
Brass spare toilet paper holder.

CR



SU66CR
Portascopino in acciaio INOX.
Stainless steel broom rack holder.

CR



SU40CR
Portasalviette in ottone, lunghezza cm 40.
Brass towel holder, length cm 40.

CR



SU30CR
Portasalviette in ottone, lunghezza cm 60.
Brass towel holder, length cm 60.

CR



SU20CR
Mensola in vetro con supporti in ottone, dimensione 11x49,5 cm.
Glass shelf with brass support, dimensions 11x49,5 cm.

CR



SU33CR
Portasalviette doppio in ottone, lunghezza cm 60.
Brass double towel holder, length cm 60.

CR



SUSET8PCR
Set serie SQ composto da 8 accessori:

- 2 portasapone
- 1 portabicchiere
- 1 portasalviette cm 60
- 1 portasalviette cm 40
- 1 portasalviette ad anello
- 1 appendino
- 1 portarotolo

Set SQ serie composta di 8 accessories:

- 2 soap dish holders
- 1 cup holder
- 1 towel holder cm 60
- 1 towel holder cm 40
- 1 towel ring
- 1 hook
- 1 toilet paper roll holder

RICAMBI - SPARE PARTS



AC66SU
Scopino da bagno.
Toilet brush.

CR



ACGL10SU
Portasapone in vetro satinato.
Satin glass soap holder.

CR



ACGL13
Dispenser in vetro satinato.
Satin glass soap dispenser.

CR



ACGL15
Bicchiere in vetro satinato.
Satin glass.

CR

EPOCA

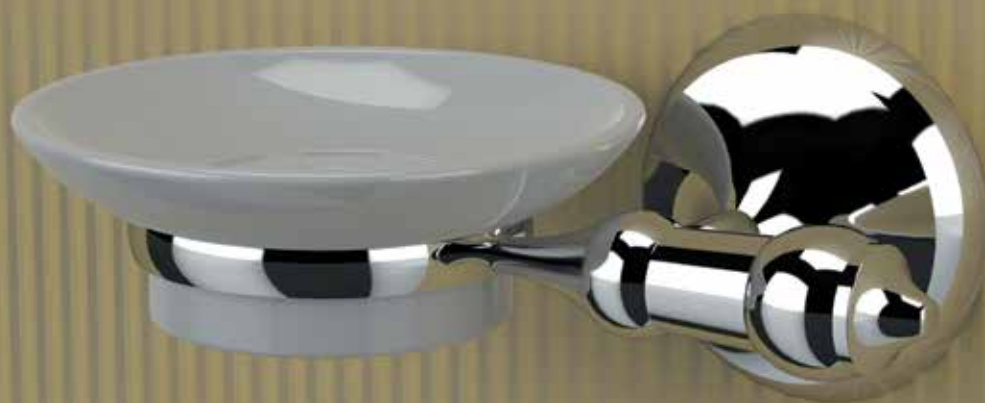

**IN CERAMICA BIANCA
IN WHITE CERAMIC**

EP10CR

**EP13CR**

Dispenser per sapone liquido in ceramica con supporto in ottone.
Ceramic soap dispenser with brass support.

CR

**EP15CR**

Portabicchiere in ottone con bicchiere in ceramica.
Brass cup holder with ceramic glass.

CR

**EP10CR**

Portasapone in ceramica con supporto in ottone.
Ceramic soap dish holder with brass support.

CR

**EP50CR**

Appendino in ottone.
Cp brass hook.

CR

**EP44CR**

Portasalviette ad anello in ottone.
Brass towel ring.

CR

**EP60CR**

Portarotolo in ottone.
Brass toilet paper holder.

CR

**EP62CR**

Portarotolo di ricambio in ottone.
Brass spare toilet paper holder.

CR

**EP66CR**

Portascopino in ceramica con supporto in ottone.
Ceramic broom rack holder with brass support.

CR



EP20CR

Mensola in vetro con supporti in ottone, dimensione 12x52,5 cm.
Glass shelf with brass support, dimensions 12x52,5 cm.

CR



EP40CR

Portasalviette in ottone, lunghezza cm 40.
Brass towel holder, length cm 40.

CR



EP30CR

Portasalviette in ottone, lunghezza cm 60.
Brass towel holder, length cm 60.

CR



EP33CR

Portasalviette doppio in ottone, lunghezza cm 60.
Brass double towel holder, length cm 60.

CR



EPSET8PCR

Set serie SQ composto da 8 accessori:

Set SQ serie composed of 8 accessories:

- 2 portasapone
- 1 portabicchiere
- 1 portasalviette cm 60
- 1 portasalviette cm 40
- 1 portasalviette ad anello
- 1 appendino
- 1 portarotolo

- 2 soap dish holders
- 1 cup holder
- 1 towel holder cm 60
- 1 towel holder cm 40
- 1 towel ring
- 1 hook
- 1 toilet paper roll holder

CR

RICAMBI - SPARE PARTS



AC66AR

Scopino da bagno.
Toilet brush.

CR



ACCE10

Portasapone in ceramica.
Ceramic soap holder.

CR



ACCE13WI

Dispenser in ceramica.
Ceramic soap dispenser.

CR



ACCE15

Bicchiere in ceramica.
Ceramic glass.

CR

ACCESSORI ACCESSORIES



RB281CR



RB211CR

Portasapone piccolo rettangolare in ottone.
Dimensioni: 12x9x3 cm.
Brass small rectangular shaped soap holder.
Dimensions: 12x9x3 cm.

CR



RB271CR

Portasapone piccolo angolare in ottone.
Dimensioni: 17x11,5x3,2 cm.
Brass small corner soap holder.
Dimensions: 17x11,5x3,2 cm.

CR



RB281CR

Portasapone piccolo ovale in ottone.
Dimensioni: 16x10x3,4 cm.
Brass big oval soap holder.
Dimensions: 16x10x3,4 cm.

CR



RB212CR

Portasapone grande rettangolare in ottone.
Dimensioni: 20,5x11,5x3 cm.
Brass big rectangular shaped soap holder.
Dimensions: 20,5x11,5x3 cm.

CR



RB272CR

Portasapone grande angolare in ottone.
Dimensioni: 22x14,3x6 cm.
Brass big corner soap holder.
Dimensions: 22x14,3x6 cm.

CR



RB282CR

Portasapone grande ovale in ottone.
Dimensioni: 24,5x11,8x3,4 cm.
Brass small oval soap holder.
Dimensions: 24,5x11,8x3,4 cm.

CR



RB430CR

Portasalvietta in ottone da cm 60.
Brass towel holder bar, cm 60.

CR



RB440CR

Portasalvietta in ottone da cm 40.
Brass towel holder bar cm 40.

CR



RB310CR

Appendiabito a muro minimale.
Brass minimal hook.

CR



RB312CR

Appendiabiti in linea a due ganci in ottone.
Dimensioni: 20x3 cm.
Brass clothes holder, two hooks.
Dimensions: 20x3 cm.

CR



RB313CR

Appendiabiti in linea a tre ganci in ottone.
Dimensioni: 32x3 cm.
Brass clothes holder, three hooks.
Dimensions: 32x3 cm.

CR



RB490CR

Sistema filo stendibiancheria in ottone.
Brass clothes line system.

CR



RB277CR

Portasapone doppio angolare in ottone.
Dimensioni: 30,5 x19x19,5 cm.
Brass small corner double soap holder.
Dimensions: 30,5 x19x19,5 cm.

CR



RB480CR

Maniglione vasca con portasapone in ottone.
Dimensioni: 43x21x13 cm.
Brass bathtub handle with soap holder.
Dimensions: 43x21x13 cm.

CR



RB470CR

Portasciugamano multiplo in ottone cm 60.
Brass multiple bar towel holder cm 60.

CR



RB501CR
Portarifiuti, 3 litri, in acciaio INOX.
Altezza 26 cm, Ø 17 cm.
*Toilet bin, 3 liters, in stainless steel.
Height 26 cm, Ø 17 cm.*

CR



RB502CR
Portarifiuti, 5 litri, in acciaio INOX.
Altezza 29 cm, Ø 20 cm.
*Toilet bin, 5 liters, in stainless steel.
Height 29 cm, Ø 20 cm.*

CR



RB503CR
Portarifiuti, 12 litri, in acciaio INOX.
Altezza 39 cm, Ø 25 cm.
*Toilet bin, 12 liters, in stainless steel.
Height 39 cm, Ø 25 cm.*

CR



RB600CR
Dispenser per liquidi in acciaio INOX, capacità
730 ml. Dimensioni: 18,3x10,7x6 cm.
*Dispenser for liquids in stainless steel, capacity
730 ml. Dimensions: 18,3x10,7x6 cm.*

CR



SE71
Dispenser a sensore per sapone liquido e "liquido
disinfettante". Capacità: 650 ml, batteria: 6 x 1,5V.
*Sensor dispenser for liquid soap and "liquid
disinfectant". Capacity: 650 ml, battery: 6 x 1,5 V.*

CR



CE



RB630CR
Specchio ingranditore a doppia faccia, a muro Ø
15 cm.
*Wall mounted magnifier mirror, double side, Ø
15 cm.*

CR



RB465CR
Portascopino sospeso in ottone.
Wall mounted broom rack all in Brass.

CR



RB466CR
Portascopino in acciaio INOX.
Broom rack all in stainless steel.

CR



RB635CR
Specchio ingranditore a doppia faccia, a muro Ø
21 cm.
*Wall mounted magnifier mirror, double side, Ø
21 cm.*

CR



AH75LED

Specchio ingranditore retroilluminato, con spina e interruttore. Ø 21,5 cm, estensione max 26 cm.
Magnifier backlighted mirror, power supply, and switch. Ø 21,5 cm, maximum extension 26 cm.

CR



AH77QLED

Specchio ingranditore retroilluminato, accensione al tocco, spegnimento automatico, a batteria. 18x18 cm, estensione max 34 cm.
Magnifier backlighted mirror, power touch, automatic shutdown, battery powered. 18x18 cm, maximum extension 34 cm.

CR

SHUT-OFF

PLACCHE WC
TOILET PLATES

LAVABO
WASHBASIN

LOUNGE

FLAT

GUEST

SUITE

EPOCA

ACCESSORI
ACCESSORIES

IDROSCOPINI
HYDRO-BRUSH

COMPLEMENTI
COMPL. ITEMS

RICAMBI
SPARE PARTS

IDROSCOPINI HYDRO-BRUSH



RB140S01



RB100

Idroscopino a pulsante "Lux" in ottone, con impugnatura liscia 1/2".
Brass hydro brush "Lux" with plain handgrip, 1/2".

CR



RB120

Idroscopino a pulsante quadrata, serie "SQ", in ottone, 1/2".
Brass hydro brush serie "SQ", with plain handgrip, 1/2".

CR



336L

Rubinetto d'arresto serie Minimal, con supporto doccia in ottone, per flessibile con attacco conico.
Brass minimal angle valve with shower holder, for conical nut flexibles.

CR



336S

Rubinetto d'arresto quadrato, con supporto doccia in ottone, per flessibile con attacco conico.
Brass squared angle valve with shower holder, for conical nut flexibles.

CR

Gli idroscopini e i set con idroscopini sono indicati per la pulizia dei sanitari. Il rubinetto a muro apre e chiude la fornitura di acqua, mentre la doccetta a pulsante permette di gestire l'erogazione durante l'utilizzo.

Hydro-brushes and Hydro-brush sets are suitable for the cleaning of sanitary ware. The wall tap opens and closes the water supply, while the push-button shower allows you to activate the flow during use.

SHUT-OFF

PLACCHE WC
TOILET PLATES

LAVABO
WASHBASIN

LOUNGE

FLAT

GUEST

SUITE

EPOCA

ACCESSORI
ACCESSORIES

IDROSCOPINI
HYDRO-BRUSH

COMPLEMENTI
COMPL. ITEMS

RICAMBI
SPARE PARTS



RB100S01

Set composto da: idroscopino a pulsante, flessibile con attacco conico cm 120 metallizzato in PVC, rubinetto ad angolo Minimal con vitone ceramico e supporto doccia "Lux" in ottone.
Set composed of: hydro brush handshower, PVC metallized conical flexible hose cm 120, "Minimal" angle valve with ceramic eadwork and "Lux" brass shower holder.

CR



RB100S02

Set composto da: idroscopino a pulsante, flessibile con attacco conico cm 120 in PVC con piattina cromata, rubinetto d'arresto Minimal con vitone ceramico e supporto doccia "Lux" in ottone.
Set composed of: hydro brush handshower, PVC in chrome flat conical flexible hose cm 120, "Minimal" angle valve with ceramic eadwork and "Lux" brass shower holder.

CR



RB100TE

Set composto da: idroscopino a pulsante in ottone, flessibile conico cm 120, rubinetto temporizzato 1/2" in ottone, tempo d'apertura 6-8 secondi.
Set composed of: hydro brush in brass, flexible cm 120, temporized button flusher 1/2" all in brass, opening time 6-8 seconds.

CR



RB140S01

Set composto da: idroscopino a pulsante, flessibile con attacco conico cm 120 metallizzato in PVC, rubinetto ad angolo Minimal con vitone ceramico e supporto doccia "Lux" in ottone, comprensivo di doccetta RB100.
Set including: push-button hydrobrush, 120 cm metallized PVC flexible hose with conical connection, "Minimal" angle tap with ceramic head valve and brass "Lux" shower holder, including hand shower (RB100).

CR



RB160S01

Set composto da: idroscopino a pulsante, flessibile con attacco conico cm 120 metallizzato in PVC, rubinetto ad angolo SQ con vitone ceramico e supporto doccia "Lux" in ottone, comprensivo di doccetta RB120.
Set including: push-button hydrobrush, 120 cm metallized PVC flexible hose with conical connection, SQ corner tap with ceramic head valve and brass "Lux" shower holder, including hand shower (RB120).

CR



RB120S01

Set composto da: idroscopino a pulsante, flessibile con attacco conico cm 120 metallizzato in PVC, rubinetto ad angolo SQ con vitone ceramico e supporto doccia "Lux" in ottone.
Set composed of: hydro brush handshower, PVC metallized conical flexible hose cm 120, "SQ" angle valve with ceramic eadwork and "Lux" brass shower holder.

CR



RB120S02

Set composto da: idroscopino a pulsante, flessibile con attacco conico cm 120 in PVC con piattina cromata, rubinetto d'arresto SQ con vitone ceramico e supporto doccia "Lux" in ottone.
Set composed of: hydro brush handshower, PVC in chrome flat conical flexible hose cm 120, "SQ" angle valve with ceramic eadwork and "Lux" brass shower holder.

CR

COMPLEMENTI - COMPL. ITEMS

COMPLEMENTI COMPLEMENTARY ITEMS





SHUT-OFF

PLACCHE WC
TOILET PLATES

LAVABO
WASHBASIN

LOUNGE

FLAT

GUEST

SUITE

EPOCA

ACCESSORI
ACCESSORIES

IDROSCOPINI
HYDRO-BRUSH

COMPLEMENTI
COMPL. ITEMS

RICAMBI
SPARE PARTS

SIFONI IN FINITURA - SIPHONS IN FINISH

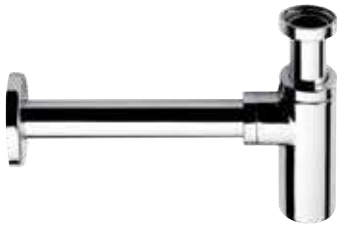

958L

Sifone "MINIMAL" in ottone, per lavabo, 1"1/4, canotto cm 30 e rosone pesante.
Brass "MINIMAL" P trap, for wash-basin, 1"1/4, outlet tube cm 30 and heavy flange.

CR FIN 1 FIN 2

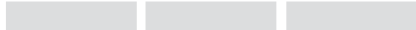

958B

Sifone "MINIMAL" in ottone, per bidet, 1"1/4, canotto cm 30 e rosone pesante.
Brass "MINIMAL" P trap, for bidet, 1"1/4, outlet tube cm 30 and heavy flange.

CR FIN 1 FIN 2

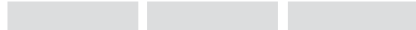

960114

Sifone SQ, in ottone, canotto cm 30, 1"1/4, con rosone pesante quadrato.
Brass SQ trap, 30 cm outlet tube, 1"1/4, with heavy squared wall flange.

CR FIN 1 FIN 2

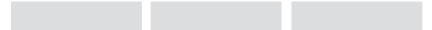

SIFONI SALVASPAZIO - SAVE SPACING SIPHONS



985

Sifone salvaspazio con piletta click-clack incorporata con troppo pieno, rotondo, cromato.
Save-spacing siphon with click-clack built-in drain with overflow, round, chrome.

CR FIN 1 FIN 2

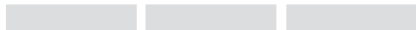

984

Sifone salvaspazio con piletta click-clack incorporata senza troppo pieno, rotondo, cromato.
Save-spacing siphon with click-clack built-in drain without overflow, round, chrome.

CR FIN 1 FIN 2

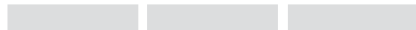

985S

Sifone salvaspazio con piletta click-clack incorporata con troppo pieno, quadrato, cromato.
Save-spacing siphon with click-clack built-in drain with overflow, squared, chrome.

CR FIN 1 FIN 2

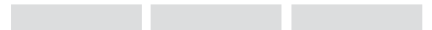

984S

Sifone salvaspazio con piletta click-clack incorporata senza troppo pieno, quadrato, cromato.
Save-spacing siphon with click-clack built-in drain without overflow, squared, chrome.

CR FIN 1 FIN 2

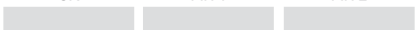

SIFONI - TRAPS



Sifone a "P" in tubo, in ottone.
"P" trap made by tube, in brass.

977114 1"1/4



Sifone "P" in tubo, in acciaio INOX.
"P" trap made by tube, in stainless steel.

977X114 1"1/4



Sifone a bottiglia in ottone, canotto cm 25.
Brass bottle trap, 25 cm outlet tube.

97010 1"

970114 1"1/4

970112 1"1/2



Sifone a bottiglia in zama senza piletta, per lavabo, 1" 1/4, canotto cm. 20.
Bottle trap in zamac without waste, for wash-basin, 1" 1/4, outlet tube cm 20.

970Z114 1"1/4

970Z112 1"1/2



Sifone a "S" in ottone, canotto cm 25.
Brass "S" trap, 25 cm outlet tube.

971114 1"1/4



Sifone a "S" in zama, canotto cm 25.
"S" trap in zamac, 25 cm outlet tube.

971Z114 1"1/4



Sifone a "U" per lavabo a colonna in ottone, canotto cm 25.
Brass "U" trap, 25 cm outlet tube.

972114 1"1/4

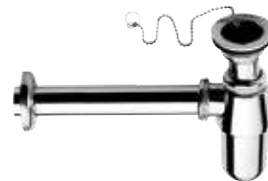

Sifone a bottiglia in zama con piletta, per lavabo.
Bottle trap in zamac with waste, for wash-basin.

973Z114 1"1/4



Sifone fuso pesante lusso in ottone, per lavabo e bidet
1", 1" 1/4 canotto cm 30.
Brass luxury "P" trap, heavy type, 1", 1" 1/4, outlet tube cm 30.

95610 1"

956114 1"1/4

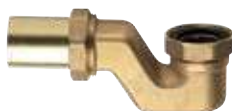

Sifone pesante in ottone fuso, con dado 1"1/2 per colonna vasca.
Heavy trap in casting brass, with nut 1"1/2 for bath waste and overflow.

98112 1"1/2



Ghiera per sifoni in ottone, 1" M x 1"1/4 F, 1"1/4 M x 1"1/2 F.
Brass reduction for trap 1" M x 1"1/4 F, 1"1/4 M x 1"1/2 F.

96810M114F 1" M x 1"1/4 F

968114M112F 1" 1/4 M x 1"1/2 F



Ghiera per sifoni in ottone, 1"1/4 M x 1" F, 1"1/2 M x 1"1/4 F.
Brass reduction for trap 1"1/4 M x 1" F, 1"1/2 M x 1"1/4 F.

969112M114F 1"1/2 M x 1"1/4 F

969114M10F 1"1/4 M x 1" F

SCARICHI AUTOMATICI CLICK-CLACK - AUTOMATIC CLICK CLACK POP-UP WASTES



904CC2114

Scarico automatico con sistema click-clack, 1"1/4, e tappo grande, senza troppo pieno, modello con bicchiere corto.

Automatic pop-up waste, click-clack system, 1"1/4, big plug, without overflow, model with shorter cup.

CR FIN 1 FIN 2

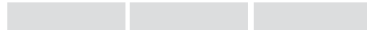

904CC114

Scarico automatico con sistema click-clack, 1"1/4, e tappo grande, senza troppo pieno.

Automatic pop-waste, click-clack system, 1"1/4, big plug, without overflow.

CR FIN 1 FIN 2

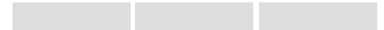

904SCC2114

Scarico automatico quadrato 1"1/4 con click-clack senza troppo pieno, modello con bicchiere corto.

Squared automatic pop-up waste 1"1/4 with click-clack system without overflow, model with shorter cup.

CR FIN 1 FIN 2

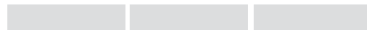

904SCC114

Scarico automatico quadrato 1"1/4 con click-clack senza troppo pieno.

Squared automatic pop-up waste 1"1/4 with click-clack system without overflow.

CR FIN 1 FIN 2

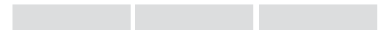

905CC2

Scarico automatico 1"1/4 con click-clack con troppo pieno, modello con bicchiere corto.

Automatic pop-up waste 1"1/4 with click-clack system with overflow, model with shorter cup.

CR FIN 1 FIN 2

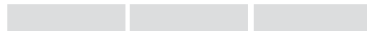

905CC114

Scarico automatico con sistema click-clack, 1"1/4, e tappo grande, con troppo pieno.

Automatic pop-up waste, 1"1/4, click-clack system, big plug, with overflow, model with shorter cup.

CR FIN 1 FIN 2

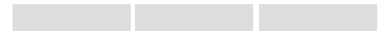

905SCC2114

Scarico automatico quadrato 1"1/4 con click-clack con troppo pieno, modello con bicchiere corto.

Squared automatic pop-up waste 1"1/4 with click-clack system with overflow, model with shorter cup.

CR FIN 1 FIN 2

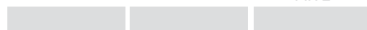

905SCC114

Scarico automatico con sistema click-clack, 1"1/4, e tappo grande, con troppo pieno.

Squared automatic pop-up waste, click-clack system, 1"1/4, with overflow.

CR FIN 1 FIN 2

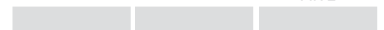

906CC2114

Scarico automatico con sistema click-clack, 1"1/4, con troppo pieno, modello con bicchiere corto.

Automatic pop-up waste, click-clack system, 1"1/4, with overflow, model with shorter cup.

CR FIN 1 FIN 2



906CC114

Scarico automatico con sistema click-clack, 1"1/4, con troppo pieno.

Automatic pop-up waste, 1"1/4, click-clack system, with overflow.

CR FIN 1 FIN 2



9072114

Scarico automatico 1"1/4 con tappo grande sempre aperto e sistema click-clack per la pulizia interna, modello con bicchiere corto.

Automatic pop-up waste 1"1/4 with big plug always opened, and click-clack system for internal cleaning, model with shorter cup.

CR FIN 1 FIN 2

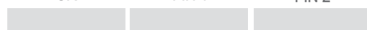

907114

Scarico automatico 1"1/4 con tappo grande sempre aperto e sistema click-clack per la pulizia interna.

Automatic pop-up waste 1"1/4 with big plug always opened, and click-clack system for internal cleaning.

CR FIN 1 FIN 2

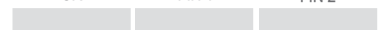



905CCR114
Scarico automatico universale con chiusura click-clack da 1"1/4.
Universal automatic pop-up waste 1"1/4 with click-clack system.

CR	FIN 1	FIN 2
----	-------	-------



905CCXL114
Scarico automatico con sistema click-clack, 1" 1/4, tappo grande, con troppo pieno, versione extralunga.
Automatic pop-up waste, click-clack system, 1" 1/4, big plug, with overflow, extralong version.

CR	FIN 1	FIN 2
----	-------	-------

SCARICHI AUTOMATICI - POP-UP WASTES



Scarico automatico 1", 1"1/4.
Brass pop-up waste, 1", 1"1/4.

95	1"
95	1"1/4



Scarico automatico da 1"1/4, tipo Lusso.
Brass pop-up waste 1"1/4, luxury type.

95L80	1"1/4
-------	-------



Scarico automatico in plastica da 1"1/4.
Plastic pop-up waste, 1"1/4.

95P80	1"1/4
-------	-------



Scarico automatico da 1"1/4, in zama.
Zamac 1"1/4 pop-up waste.

95Z	1"1/4
-----	-------



Scarico automatico da 1"1/4, tipo lusso lucidato, con tappo grande quadrato piatto a copertura totale della piletta.
C.p. polished pop-up waste, 1"1/4, luxury type with big squared flat plug covering the drain.

95LS80	1"1/4
--------	-------



Scarico automatico da 1"1/4, tipo lusso lucidato, con tappo grande a copertura totale della piletta.
C.P. polished pop-up waste, 1"1/4, luxury type with big plug covering the drain.

95LG80	1"1/4
--------	-------



Scarico tipo America o Americano, in ottone pulito e cromato.
C.p. waste model America or American, polished and in brass.

95AM	1"1/4
------	-------

RUBINETTI SOTTOLAVABO - ANGLE VALVES



117RA

Raccordo 3/8x10 con guarnizioni in 3 pezzi.
C.P. nut with 3 pcs washers 3/8x10.

CR



117RA1210

Raccordo 1/2x10 con guarnizioni in 3 pezzi.
C.P. nut with 3 pcs washers 1/2x10.

CR



Rubinetto sottolavabo con rosetta.
Brass angle valve with flange.

CR

1171212 1/2x1/2

1171238 1/2x3/8



1171210

Rubinetto sottolavabo con calotta e rosetta,
1/2x10.
Brass angle valve with flange, 1/2x10.

CR



1241210

Curvetta sottolavabo, 1/2x10, con rosetta in
ottone.
Brass elbow connection for wash basin, with
flange, 1/2x10.

CR



120SN1210

Rubinetto sottolavabo a vitone, con filtro e snodo,
1/2x10, con rosetta in ottone.
Brass angle valve with filter, balljoint and brass
flange, 1/2x10.

CR



121T

Rubinetto combinato 1/2" sottolavabo e 3/4"
attacco lavatrice, 1/2x3/4x10
Brass union valve 1/2", with undersink coupling
and 3/4" connection for washing machine,
1/2x3/4x10.

CR



1231210

Rubinetto sottolavabo con filtro e calotta,
1/2x10, con rosetta in ottone.
Brass angle valve with filter and flange,
1/2x10.

CR



123SN1210

Rubinetto sottolavabo con filtro e snodo,
1/2x10, con rosetta in ottone.
Brass angle valve with filter, ball joint and flange,
1/2x10.

CR

**1231212**

Rubinetto sottolavabo con filtro, 1/2x1/2, con rosetta in ottone.

Brass angle valve with filter and flange, 1/2x1/2.

CR

**127A1210**

Rubinetto sottolavabo con filtro, calotta, 1/2x10 e rosetta in ottone.

Brass angle valve with filter and flange, 1/2x10.

CR

**1291212**

Rubinetto sottolavabo 1/2x1/2 con rosetta.

Brass angle valve for wash basin 1/2x1/2 with flange.

CR

1231234

Rubinetto sottolavabo con filtro, 1/2x3/4, con rosetta in ottone.

Brass angle valve with filter and flange, 1/2x3/4.

CR

127A1212

Rubinetto sottolavabo con filtro, 1/2x1/2, con rosetta in ottone.

Brass angle valve with filter and flange, 1/2x1/2.

CR

1291238

Rubinetto sottolavabo 1/2x3/8 con rosetta.

Brass angle valve for wash basin 1/2x3/8 with flange.

CR

1231238

Rubinetto sottolavabo con filtro, 1/2x3/8, con rosetta in ottone.

Brass angle valve with filter and flange, 1/2x3/8.

CR

127A1238

Rubinetto sottolavabo con filtro, 1/2x3/8, con rosetta in ottone.

Brass angle valve with filter and flange, 1/2x3/8.

CR

**128R1210**

Rubinetto a sfera con guarnizione in PTFE, con calotta e rosetta in ottone, 1/2x10.

Brass ball valve with PTFE washer and flange, 1/2x10.

CR

**128R1212**

Rubinetto a sfera con guarnizione in PTFE e rosetta, 1/2x1/2.

Brass ball valve with PTFE washer and flange, 1/2x1/2.

CR

**128E1238**

Rubinetto sottolavabo "Esagonale", con vitone ceramico, 1/2x3/8.

Brass "Hexagonal" angle valve, with ceramic head valve, 1/2x3/8.

CR

**127ASN1210**

Rubinetto sottolavabo con filtro e snodo, 1/2x10, con rosetta in ottone.

Brass angle valve with filter, ball joint and flange, 1/2x10.

CR

128R1238

Rubinetto a sfera con guarnizione in PTFE e rosetta, 1/2x3/8.

Brass ball valve with PTFE washer and flange, 1/2x3/8.

CR

128E1210

Rubinetto sottolavabo "Esagonale", con dado e guarnizione art. 117 RA, con vitone ceramico, 1/2x10.

Brass "Hexagonal" angle valve, with nut and washers art. 117 RA, with ceramic head valve, 1/2x10.

CR

128E1212

Rubinetto sottolavabo "Esagonale", con vitone ceramico, 1/2x1/2.

Brass "Hexagonal" angle valve, with ceramic head valve, 1/2x1/2.

CR

SHUT-OFF

PLACCHE WC
TOILET PLATESLAVABO
WASHBASIN

LOUNGE

FLAT

GUEST

SUITE

EPOCA

ACCESSORI
ACCESSORIESIDROSCOPINI
HYDRO-BRUSHCOMPLEMENTI
COMPL. ITEMSRICAMBI
SPARE PARTS



128L1212

Rubinetto sottolavabo "MINIMAL", con vitone ceramico, con maniglia a leva, 1/2x1/2.
Brass "MINIMAL" angle valve, with ceramic headvalve, with lever handle, 1/2x1/2.



128S1238

Rubinetto sottolavabo quadrato, con vitone ceramico, 1/2x3/8.
Brass squared angle valve, with ceramic head valve, 1/2x3/8.



128L1238

Rubinetto sottolavabo "MINIMAL", con vitone ceramico, con maniglia a leva, 1/2x3/8.
Brass "MINIMAL" angle valve, with ceramic headvalve, with lever handle, 1/2x3/8.



128S1210

Rubinetto sottolavabo quadrato, con dado e guarnizione art. 117 RA, con vitone ceramico, 1/2x10.
Brass squared angle valve, with nut and washers art. 117 RA, with ceramic head valve, 1/2x10.



128L1210

Rubinetto sottolavabo "MINIMAL", con vitone ceramico, con maniglia a leva, dado e guarnizione art. 117 RA, 1/2x10.
Brass "MINIMAL" angle valve, with ceramic headvalve, with lever handle, nut and washers art. 117 RA, 1/2x10.



128S1212

Rubinetto sottolavabo quadrato, con vitone ceramico, 1/2x1/2.
Brass squared angle valve, with ceramic head valve, 1/2x1/2.



67

Bocca a snodo per lavello.
Swivel spout for washbasin.



67N

Bocca alta minimale.
Minimal high spout.



67Q

Bocca alta quadrata.
Squared high spout.



31N

Rubinetto d'arresto minimale 1/2".
1/2" minimal angle valve.



31N34

Rubinetto d'arresto minimale 3/4".
3/4" minimal angle valve.



31W

Rubinetto doccia incasso 1/2".
Built-in right valve 1/2".





128L121215

SHUT-OFF

PLACCHE WC
TOILET PLATES

LAVABO
WASHBASIN

LOUNGE

FLAT

GUEST

SUITE

EPOCA

ACCESSORI
ACCESSORIES

IDROSCOPINI
HYDRO-BRUSH

COMPLEMENTI
COMPL. ITEMS

RICAMBI
SPARE PARTS

COLONNE PER BORDO VASCA - VERTICAL CONNECTIONS FOR BATH MIXER



8801LI

Coppia colonne vasca in ottone, serie Liberty, 3/4M x 3/4M.
Couple brass vertical connections for bath mixer, serie Liberty, 3/4M x 3/4M.

CR



8801LIS

Coppia colonne vasca in ottone, serie Liberty, con supporto doccia, 3/4M x 3/4M.
Couple brass vertical connections for bath mixer, serie Liberty, with handshower holder 3/4M x 3/4M.

CR

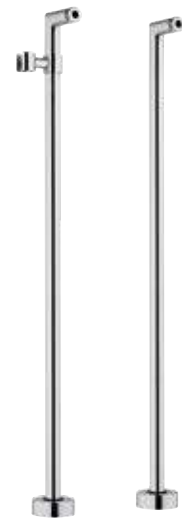

88N02

Coppia colonne vasca in ottone, serie Minimal, con supporto doccia, 3/4M x 3/4M.
Couple brass vertical connections for bath mixer, serie Minimal, with handshower holder 3/4M x 3/4M.

CR



88UK

Coppia colonnette bordo vasca in ottone, serie UK, 3/4Mx3/4M.
Couple brass vertical connections for bath mixer, serie UK, 3/4M x 3/4M.

CR



88LI

Coppia colonnette bordo vasca in ottone, serie Liberty, 3/4M x 3/4M.
Couple brass vertical connections for bath mixer, serie Liberty, 3/4M x 3/4M.

CR



88

Colonnetta per bordo vasca in ottone, 1/2M x 3/4M.
Brass vertical connection for bath mixer, 1/2M x 3/4M.

CR

DEVIATORI - DIVERTERS



Q93DEV3

Deviatore a tre vie (una entrata e tre uscite) su piastra, serie Qubika.
Three ways diverter (1 inlet and 3 outlets) on flange, Qubika serie.

CR



N93DEV3

Deviatore a tre vie (una entrata e tre uscite) su piastra, serie Minimal.
Three ways diverter (1 inlet and 3 outlets) on flange, Minimal serie.

CR



Q93DEV7

Deviatore a tre vie e sette posizioni (una entrata, tre uscite e sette posizioni con cui selezionare uscite singole o miscelate tra loro) su piastra, serie Qubika.
Three ways diverter with seven positions (1 inlet and 3 outlets and seven positions to select single or mixed outlets) on flange, Qubika serie.

CR



N93DEV7

Deviatore a tre vie e sette posizioni (una entrata, tre uscite e sette posizioni con cui selezionare uscite singole o miscelate tra loro) su piastra, serie Minimal.
Three ways diverter with seven positions (1 inlet and 3 outlets and seven positions to select single or mixed outlets) on flange, Minimal serie.

CR



COPERTURA A PAVIMENTO IN ACCIAIO INOX - STAINLESS STEEL FLOOR DRAINS

//////////////////// cm 10 x 10 //////////////////////

**913GVC10**

Copertura a pavimento in acciaio inox cm 10x10, con griglia fissa e coperchio mobile.

Stainless steel floor drain cm 10x10, with fixed grill and swivel plug.

CR

**913GV10**

Copertura a pavimento in acciaio inox cm10x10, con griglia fissa.

Stainless steel floor drain cm 10x10, with fixed grill.

CR

//////////////////// cm 15 x 15 //////////////////////

**913GVC15**

Copertura a pavimento in acciaio inox cm 15x15, con griglia fissa e coperchio mobile.

Stainless steel floor drain cm 15x15, with fixed grill and swivel plug.

CR

**913GV15**

Copertura a pavimento in acciaio inox cm 15x15, con griglia fissa.

Stainless steel floor drain cm 15x15, with fixed grill.

CR

**913CV15**

Copertura a pavimento in acciaio inox cm15x15, con coperchio avvitato fisso.

Stainless steel floor drain cm 15x15, with fixed plug.

CR

**913GFC15**

Copertura a pavimento in acciaio inox cm 15x15, con griglia e coperchio mobili.

Stainless steel floor drain cm 15x15, with swivel grill and swivel plug.

CR

//////////////////// cm 20 x 20 //////////////////////

**913GVC20**

Copertura a pavimento in acciaio inox cm 20x20, con griglia fissa e coperchio mobile.

Stainless steel floor drain cm 20x20, with fixed grill and swivel plug.

CR

**913GV20**

Copertura a pavimento in acciaio inox cm 20x20, con griglia fissa.

Stainless steel floor drain cm 20x20, with fixed grill.

CR

**913CV20**

Copertura a pavimento in acciaio inox cm 20x20, con coperchio avvitato fisso.

Stainless steel floor drain cm 20x20, with fixed plug.

CR

**913GFC20**

Copertura a pavimento in acciaio inox cm 20x20, con griglia e coperchio mobili.

Stainless steel floor drain cm 20x20, with swivel grill and swivel plug.

CR

SIFONI ANTI SCARAFAGGIO - *ANTI COCKROACH-INSECTS TRAPS*



913PSA01

Sifone anti-scarafaggio da utilizzare per coperture a pavimento cm 15x15 e 20x20.
Anti cockroach-insects to use under the floor drains with size cm 15x15 e 20x20.

CR



913PSA02

Sifone anti-scarafaggio da utilizzare per coperture a pavimento cm 10x10.
Anti cockroach-insects to use under the floor drains with size cm 10x10.

CR

CANALINE SIFONATE RETTANGOLARI - *RECTANGULAR FLOOR DRAINS*



Canalina sifonata a pavimento, in acciaio inox, con griglia di drenaggio, larghezza 12,5 cm lunghezze cm 70, 80, 90, 100, 120.
Rectangular floor drain, in stainless steel, with drain grill, large 12.5 cm, lengths cm 70, 80, 90, 100, 120.

913RG1270	70 cm
913RG1280	80 cm
913RG1290	90 cm
913RG12100	100 cm
913RG12120	120 cm



Canalina sifonata a pavimento, in acciaio inox, piastrellabile, larghezza 12,5 cm lunghezze cm 70, 80, 90, 100, 120.
Rectangular floor drain, in stainless steel, model for tiling, large 12.5 cm, lengths cm 70, 80, 90, 100, 120.

913RP1270	70 cm
913RP1280	80 cm
913RP1290	90 cm
913RP12100	100 cm
913RP12120	120 cm

PILETTE DA PAVIMENTO SIFONATE - *STAINLESS STEEL FLOOR DRAINS AND SIPHONS*



913SF10

Piletta da pavimento sifonata in acciaio inox, cm 10x10.
Stainless steel floor drain and siphon, cm 10x10.

CR



913SF15

Piletta da pavimento sifonata in acciaio inox, cm 15x15.
Stainless steel floor drain and siphon, cm 15x15.

CR



913SF20

Piletta da pavimento sifonata in acciaio inox, cm 20x20.
Stainless steel floor drain and siphon, cm 20x20.

CR

COLONNE DI SCARICO - BATH WASTES

**96P**

Colonna di scarico automatica in plastica con filo esterno, senza dado e codulo.
Plastic combined bath waste with automatic pop-up with external wire.

CR

**96PCC**

Colonna di scarico in plastica, con piletta "click-clack".
Plastic combined bath waste and overflow, "click-clack" waste system.

CR

**96LICC**

Colonna di scarico con sifone per vasca con tubo in rame cromato e piletta click-clack, tutta cromata.
Bath brass waste with siphon, trap, chromated copper tube and click clack waste, all in chrome plated.

CR

**96LIT**

Colonna di scarico con sifone per vasca con tubo in rame cromato, tutta cromata.
Bath brass waste with siphon, trap and chromated copper tube, all in chrome plated.

CR

**96**

Colonna di scarico automatica con filo esterno e tubo in rame senza dado e codulo.
Brass automatic bath waste and overflow with external wire and copper tube.

CR

**96CC**

Colonna di scarico con tubo in rame, con piletta "click-clack".
Brass waste and overflow with copper tube and "click-clack" waste.

CR

**96VA**

Colonna di scarico automatico con filo esterno e tubo in rame cm 70, per vasca ad angolo.
Brass automatic bath waste, overflow and copper tube, cm 70, for bath tube edge.

CR

SHUT-OFF

PLACCHE WC
TOILET PLATESLAVABO
WASHBASIN

LOUNGE

FLAT

GUEST

SUITE

EPOCA

ACCESSORI
ACCESSORIESIDROSCOPINI
HYDRO-BRUSHCOMPLEMENTI
COMPL. ITEMSRICAMBI
SPARE PARTS

RICAMBI - SPARE PARTS

RICAMBI SPARE PARTS





SHUT-OFF

PLACCHE WC
TOILET PLATES

LAVABO
WASHBASIN

LOUNGE

FLAT

GUEST

SUITE

EPOCA

ACCESSORI
ACCESSORIES

IDROSCOPINI
HYDRO-BRUSH

COMPLEMENTI
COMPL. ITEMS

RICAMBI
SPARE PARTS

CARTUCCE IN BLISTER CARTRIDGES IN BLISTER



S50Y

Cartuccia Ø mm 40 a dischi in ceramica per vasca, lavabo, bidet (tipo con distributori).
Ceramic cartridge Ø 40 mm for bath, wash basin, bidet (type with distributor).

CR



S52Y

Cartuccia Ø mm 40 a dischi in ceramica per lavello, doccia (tipo piatto).
Ceramic cartridge Ø 40 mm for sink and shower (flat bottom type).

CR



R50Y

Cartuccia Ø mm 35 a dischi in ceramica per vasca, lavabo, bidet (tipo con distributori).
Ceramic cartridge Ø 35 mm for bath, wash basin, bidet (type with distributor).

CR



R52Y

Cartuccia Ø mm 35 a dischi in ceramica per lavello, doccia (tipo piatto).
Ceramic cartridge Ø 35 mm for sink and shower (flat bottom type).

CR



W50Y

Cartuccia Ø mm 35 a dischi ceramica per lavello, doccia, vasca, bidet (tipo piatto).
Ceramic cartridge Ø 35 mm for sink, shower, bath, bidet (flat bottom type).

CR

CARTUCCE - CARTRIDGES



CLICK SYSTEM



S50AF

Cartuccia ad apertura forzata Ø mm 40 a dischi ceramici per vasca, lavabo, bidet (tipo con distributori) permette un notevole risparmio idrico.
Forced opening ceramic cartridge Ø 40 mm for bath, wash basin, bidet (type with distributors) permit a remarkable saving of water.

CR



CLICK SYSTEM



S52AF

Cartuccia ad apertura forzata Ø mm 40 a dischi ceramici per lavello, doccia (tipo piatto) permette un notevole risparmio idrico.
Forced opening ceramic cartridge Ø 40 mm for sink, shower (flat bottom type) permit a remarkable saving of water.

CR



CLICK SYSTEM



R50AF

Cartuccia ad apertura forzata Ø mm 35 a dischi ceramici per lavello, doccia (tipo con distributori) permette un notevole risparmio idrico.
Forced opening ceramic cartridge Ø 35 mm for sink, shower (type with distributors) permit a remarkable saving of water.

CR



CLICK SYSTEM



R52AF

Cartuccia ad apertura forzata Ø 35 mm a dischi ceramici per lavello, doccia (tipo piatto) permette un notevole risparmio idrico.
Forced opening ceramic cartridge Ø 35 mm for sink, shower (flat bottom type) permit a remarkable saving of water.

CR



P50

Cartuccia progressiva Ø 35 mm, con distributori, con chiusura del flusso e uscita dell'acqua verso il basso.
Ceramic cartridge Ø 35 mm, with distributors, with flow shut-off and water outlet towards the low.

CR



P52

Cartuccia progressiva Ø 35 mm, senza distributori, con chiusura del flusso e uscita dell'acqua verso il basso.
Ceramic cartridge Ø 35 mm, without distributors, with flow shut-off and water outlet towards the low.

CR



R52AP
Cartuccia lavello-doccia d.35 alta port

CR



X50125
Cartuccia Ø25 mm (tipo aperto).
Ceramic cartridge Ø25 mm (opened type).

CR



X52125
Cartuccia Ø25 mm (tipo chiuso).
Ceramic cartridge Ø25 mm (closed type).

CR



X52
Cartuccia Ø25 mm (tipo aperto).
Ceramic cartridge Ø25 mm (opened type).

CR



X52C
Cartuccia Ø25 mm (tipo chiuso).
Ceramic cartridge Ø25 mm (closed type).

CR



V50A
Cartuccia a dischi ceramici Ø 25, con uscita dell'acqua direttamente dalla parte alta dell'involucro a cilindro senza quindi essere riconvogliato verso il fondo della cartuccia.
Ceramic discs cartridge Ø 25, with water outlet directly from the top part of the cylindrical shell without being joined towards the bottom of the cartridge.

CR



V50C
Cartuccia a dischi ceramici Ø 25 mm, tipo piatto.
Ceramic cartridge Ø 25 mm, flat bottom type

CR



J50
Cartuccia a dischi ceramici Ø mm 35, movimento a "joystick", tipo piatto.
Ceramic cartridge Ø 35 mm, "joystick" movement, flat bottom type

CR



E50C
Cartuccia termostatica coassiale serie MINIMAL THERMO e QUBIKA THERMO.
Thermostatic coaxial cartridge serie MINIMAL THERMO and QUBIKA THERMO.

CR



E50P
Cartuccia termostatica con rotazione manopola a 330° angolari, blocco di sicurezza a 38°C, campo di lavoro da 5°C a 80°C, campo di pressione da 1 a 10 bar, filtro inox e sistema di sicurezza con blocco dell'erogazione in caso di mancanza di una delle due acque, realizzato con materiali termoplastici ad elevata robustezza.
Thermostatic cartridge with 330° angular handle rotation, 38° safety lock, working field from 5°C to 80°C, pressure field from 1 to 10 bar, stainless steel filter and safety system with the outlet lock in case there is one water lock, high performance thermoplastic materials.

CR

SHUT-OFF

PLACCHE WC
TOILET PLATES

LAVABO
WASHBASIN

LOUNGE

FLAT

GUEST

SUITE

EPOCA

ACCESSORI
ACCESSORIES

IDROSCOPINI
HYDRO-BRUSH

COMPLEMENTI
COMPL. ITEMS

RICAMBI
SPARE PARTS

PROLUNGHE WALLBOX - WALLBOX EXTENSIONS



WB15PROL

Prolunga scatola incasso
Adatto per :
Built-in box extension
Suitable for :
WBOX15

CR

WB92PROL

Prolunga scatola incasso
Adatto per :
Built-in box extension
Suitable for :
WBOX92 - WBOX92Z

CR

WB93PROL

Prolunga scatola incasso
Adatto per :
Built-in box extension
Suitable for :
WBOX93 - WBOX93Z

CR



WB97D2PROL

Prolunga scatola incasso
Adatto per :
Built-in box extension
Suitable for :
WBOX97D2

CR

WB97D3PROL

Prolunga scatola incasso
Adatto per :
Built-in box extension
Suitable for :
WBOX97D3

CR

WB98D2PROL

Prolunga scatola incasso
Adatto per :
Built-in box extension
Suitable for :
WBOX98D2

CR



WB98D3PROL

Prolunga scatola incasso
Adatto per :
Built-in box extension
Suitable for :
WBOX98D3

CR

WB98D4PROL

Prolunga scatola incasso
Adatto per :
Built-in box extension
Suitable for :
WBOX98D4

CR

WB98D5PROL

Prolunga scatola incasso
Adatto per :
Built-in box extension
Suitable for :
WBOX98D5

CR



PROLUNGHE - EXTENSIONS



K09PROL

Prolunga per corpo monocomando doccia incasso con deviatore per cartuccia Ø 40 mm.
Extension for built-in shower mixer body with diverter for cartridge Ø 40 mm.

CR



N09PROL

Prolunga per corpo monocomando doccia incasso con deviatore per cartuccia Ø 35 mm.
Extension for built-in shower mixer body with diverter for cartridge Ø 35 mm.

CR



N09HPROL

Prolunga per corpo monocomando doccia incasso con deviatore a vitone per cartuccia Ø 35 mm.
Extension for built-in shower mixer body with diverter for cartridge Ø 35 mm.

CR



S52PROL

Prolunga per corpo monocomando doccia incasso per cartuccia Ø 40 mm.
Extension for built-in shower mixer body for cartridge Ø 40 mm.

CR



R52PROL

Prolunga per corpo monocomando doccia incasso per cartuccia Ø 35 mm.
Extension for built-in shower mixer body for cartridge Ø 35 mm.

CR



QD15PROL

Prolunga per lavabo incasso. Anche in versione "Box Incasso". Adatto per :
Extension for built-in basin mixer. Also available in "Built-in Box" version. Suitable for :
QD15

CR



X15PROL

Prolunga per lavabo incasso. Anche in versione "Box Incasso". Adatto per :
Extension for built-in basin mixer. Also available in "Built-in Box" version. Suitable for :
X15

CR



MC15PROL

Prolunga per lavabo incasso. Anche in versione "Box Incasso". Adatto per :
Extension for built-in basin mixer. Also available in "Built-in Box" version. Suitable for :
MC15 - AL15 - CH15 - CEC15

CR



Q15PROL

Prolunga per lavabo incasso. Anche in versione "Box Incasso". Adatto per :
Extension for built-in basin mixer. Also available in "Built-in Box" version. Suitable for :
W 15 - EY15 - I15 - D15 - L15 - Q15

CR



V15PROL

Prolunga per lavabo incasso. Anche in versione "Box Incasso". Adatto per :
Extension for built-in basin mixer. Also available in "Built-in Box" version. Suitable for :
V15 - AU15

CR

DEVIATORI AUTOMATICI - AUTOMATIC DIVERTERS



DEVK9

Deviatore, per incasso doccia, in ottone automatico con molla e fermo per basse pressioni.
Automatic brass diverter with spring and lock for low pressure.

CR



DEV00

Deviatore in ottone automatico con molla e fermo per basse pressioni.
Automatic brass diverter with spring and lock for low pressure.

CR



DEV08

Deviatore in ottone automatico con molla e fermo, con prolunga 8 mm.
Automatic brass diverter with spring and lock, mm 8 extended in 1/2 side.

CR

SHUT-OFF

PLACCHE WC
TOILET PLATES

LAVABO
WASHBASIN

LOUNGE

FLAT

GUEST

SUITE

EPOCA

ACCESSORI
ACCESSORIES

IDROSCOPINI
HYDRO-BRUSH

COMPLEMENTI
COMPL. ITEMS

RICAMBI
SPARE PARTS

VITONI - HEADVALVES



76N40DW
Vitone per acqua depurata
(ricambio)

CR



76N09H
Vitone per 09H (ricambio)

CR



7719
Vitone con filetto 19/19, per rubinetti
incasso.
19/19 Head valve thread, for built-in
stop cocks.

CR



78
Vite fissa maniglia.
Screw for fixing handle.

CR



74E
Come 74, tipo leggero.
As 74, light type.

CR



74F
Vitone da 1/2 con filetto per
coprivitone M24x1.
Head valve 1/2 with thread M24x1
for head valve cover.

CR



7718
Vitone filetto 18/19 per art. 221, 223,
224, 250, 252 e altri.
18/19 Head valve thread for art.
221, 223, 224, 250, 252 and others.

CR



7738
Vitone con filetto 3/8, per rubinetti.
3/8 Head valve thread, for taps.

CR



76DX180
Vitone 180° a dischi ceramici,
broccia Ø mm 8, 20 denti, destro.
Head valve 180° ceramic discs,
broach Ø 8 mm, 20 teeth, right.

CR



76DX24
Vitone 90° a dischi ceramici, broccia
Ø 8 mm, 24 denti, destro.
Head valve 90° ceramic discs,
broach Ø 8 mm, 24 teeth, right.

CR



76DX
Vitone 90° a dischi ceramici,
broccia Ø 8 mm, 20 denti, destro.
Head valve 90° ceramic discs,
broach Ø 8 mm, 20 teeth, right.

CR



76SX180
Vitone 180° a dischi ceramici,
broccia Ø mm 8, 20 denti, sinistro.
Head valve 180° ceramic discs,
broach Ø 8 mm, 20 teeth, left.

CR



76SX24
Vitone 90° a dischi ceramici, broccia
Ø 8 mm, 24 denti, sinistro.
Head valve 90° ceramic discs,
broach Ø 8 mm, 24 teeth, left.

CR



76SX
Vitone 90° a dischi ceramici, broccia
Ø 8 mm, 20 denti, sinistro.
Head valve 90° ceramic discs,
broach Ø 8 mm, 20 teeth, left.

CR



74
Vitone da 1/2 per gruppo vasca,
lavello, batteria lavabo, rubinetto
bidet e incasso per art. 53, 55.
Head valve 1/2° for bath, sink, wash
basin, bidet and built-in stop cock
for art. 53, 55.

CR

AERATORI - AERATORS

**81A**

Aeratore anticalcare ad alta tecnologia F22, brevettato e di lunghissima durata, scocca in ottone ed interno in materiale plastico innovativo a forte resistenza.

High technology antilimestone aerator F22, patented and long-lasting, shell in brass, internal in innovative plastic material very resistant.

CR

**83A**

Aeratore anticalcare ad alta tecnologia M24, brevettato e di lunghissima durata, scocca in ottone ed interno in materiale plastico innovativo a forte resistenza.

High technology antilimestone aerator M24, patented and long-lasting, shell in brass, internal in innovative plastic material very resistant.

CR

**83C**

Chiave brevettata per la pulizia settimanale degli aeratori ad alta tecnologia art 81 A e art 83 A.

Patented key for the weekly cleaning of the high technology aerators art 81 A and 83 A.

CR

**81**

Aeratore classico con retine in inox, per gruppo lavello F22.

Classic aerator with inox nets, for sink spout F22.

CR

**83**

Aeratore classico con retine in inox, per lavabo, lavello e bidet M24.

Classic aerator with inox nets, for basin, bidet and sink, M24.

CR

**84A**

Aeratore per gruppo vasca, M28.

Aerator for bath mixer, M28.

CR

**83F16**

Aeratore F16.

F16 aerator.

CR

**81SN**

Snodo attacco F22 con ghiera M22.

Joint F22 and nut M22.

CR

**83SN**

Snodo attacco M22 con ghiera M24.

Joint M22 and nut M24.

CR

**83N41**

Aeratore M18.

M18 aerator.

CR

**85**

Aeratore con snodo per monoforo bidet, M24.

Balljoint aerator for one-hole bidet, M24.

CR

**83NESI**

Aeratore Neoperl autopulente M24X1 con erogatore in silicone morbido anticalcare per una pulizia manuale semplificata.

Neoperl aerator selfcleaning M24X1 with silicon antilimestone bottom, for soft simplified handcleaning.

CR

**83NE**

Aeratore Neoperl effetto a scomparsa, con filetto M24X1 che puo' essere sostituito senza difficoltà a tutte le rubinetterie con filettatura per aeratore M24X1. Molto indicato per modelli di design quali Qubika, Minimal, SQ.

Neoperl aerator with built-in effect, M24X1 thread, can be easily substituted to all the standard mixers with M24X1 aerators. Very indicated for design models like Qubika, Minimal, SQ.

CR

**83NEBA**

Aeratore Neoperl M24X1 con getto direzionabile tramite terminale basculante, permette con il semplice tocco della parte inferiore dell'aeratore di dirigere il flusso della direzione desiderata.

Neoperl aerator M24X1 with swivel aerator bottom that, with the simple touch, permits to move the flow to the preferred direction.

CR

SHUT-OFF

PLACCHE WC
TOILET PLATESLAVABO
WASHBASIN

LOUNGE

FLAT

GUEST

SUITE

EPOCA

ACCESSORI
ACCESSORIESIDROSCOPINI
HYDRO-BRUSHCOMPLEMENTI
COMPL. ITEMSRICAMBI
SPARE PARTS



83EU

Aeratore Neoperl M24 coin slot. Installazione e rimozione dell'aeratore utilizzando una moneta inserita nell'apposita fessura.

Neoperl aerator M24 coin slot. Installation and removal of the aerator by using a coin placed in the slot.

CR



83F165

Aeratore a scomparsa M16,5x1 (da utilizzare con chiave 83C165). Di serie nei miscelatori per lavabo della collezione X-Style.

Hidden aerator M16,5x1 (to be used with 83C165 key). Standard in the basin mixers of X-Style collection.

CR



83C165

Chiave per la sostituzione e la pulizia degli aeratori a scomparsa M16,5 (vedi modello 83F165).

Key for replacement and cleaning of M16,5 hidden aerators (see item 83F165).

CR



83FLBA

Aeratore ultrapiatto M24 basculante per regolare l'inclinazione del flusso (da utilizzare con chiave 83FLC). Di serie nei miscelatori per lavabo delle collezioni Vanity e Absolute.

Ultra-flat aerator M24 with tilting plate for adjustable stream angle (to be used with 83FLC key). Standard in basin mixers of Vanity and Absolute collections.

CR



83FLC

Chiave per la sostituzione e la pulizia degli aeratori ultrapiatti M24 (vedi modelli 83FLBA, 83EU, 83NE).

Key for replacement and cleaning of M24 ultra-flat aerators (see items 83FLBA, 83EU, 83NE).

CR



83NEX02C

Chiave per la sostituzione e la pulizia degli aeratori 83NEX02.

Key for replacement and cleaning of 83NEX02 aerators.

CR



83C185

Chiave per la sostituzione e la pulizia degli aeratori 83QK72.

Key for replacement and cleaning of 83QK72 aerators.

CR



83C16

Chiave per la sostituzione e la pulizia degli aeratori diametro 16 - 18 (83F16).

Key for replacement and cleaning of aerators diameter 16 - 18 (83F16).

CR



83NEX02

Aeratore a scomparsa M24x1 (da utilizzare con chiave 83NEX02C).

Hidden aerator M24x1 (to be used with 83NEX02C key).

CR



83QK72

Aeratore a scomparsa M18,5 x 1

Hidden aerator M18,5 x 1

CR



AERATORI: LINEA RISPARMIO IDRICO-ENERGICO E ANTIVANDALICO
AERATORS: WATER ENERGY SAVING LINE AND ANTI-VANDALISM



83AVC

Kit antivandalico e anticalcare composto da aeratore speciale per miscelatori lavabo e bidet M24 e chiave di montaggio, manutenzione e pulizia settimanale, ad alta tecnologia, brevettata. *Anti-vandalism and antilimestone kit, composed of special aerator for wash basin and bidet mixers M24 and assembly, caring and weekly cleaning key, high technology and patented.*

CR



Set risparmio idrico totale composto da raccordo doccia 1/2" in ottone a portata limitata, aeratore lavabo e bidet M24 a portata limitata e chiave di montaggio manutenzione e pulizia settimanale, ad alta tecnologia, brevettata. Il kit è disponibile in varianti da 6 litri al minuto (cod 83 SET L6) o 8 litri al minuto (cod 83 SET L8).

Total water saving set, composed of 1/2" shower connection with reduced flow in brass, wash basin and bidet aerator with reduced flow and assembly, caring and weekly cleaning key, high technology, patented. This set is available with outlet flow of 6 liters by minute (cod 83 SET L6) or 8 liters by minute (cod 83 SET L8).

83SETL6 6 lt / min

83SETL8 8 lt / min



Kit come 83 AVC, più risparmio idrico, che include anche limitatore di portata da 6 litri al minuto, art 83AVC L6, o limitatore di portata da 8 litri al minuto, art 83 AVC L8.

Kit same as 83 AVC, plus water saving, that also includes one reduction of water consumption at 6 liters by minute, art 83 AVC L6, or one reduction of water consumption at 8 liters by minute, art 83 AVC L8.

83AVCL6 6 lt / min

83AVCL8 8 lt / min



Aeratore lavabo e bidet M24, per risparmio idrico con limitatore di portata da 6 litri al minuto (art. 83 L6) o da 8 litri al minuto (art. 83 L8).

Aerator for wash basin and bidet mixers, M24, water saving, with reduction of consumption and excellent flow at 6 litres by minute (art. 83 L6) or 8 liters by minute (art. 83 L8).

83L6 6 lt / min

83L8 8 lt / min



Raccordo doccia 1/2" a risparmio idrico con limitatore di portata da 6 litri al minuto (art 309 L6) o 8 litri al minuto (art 309 L8).

Brass connection, water saving program with flow reduction at 6 liters by minute (art 309 L6) or 8 liters by minute (art 309 L8).

309RL6 6 lt / min

309RL8 8 lt / min



662FI12

Guarnizione da 1/2" con filtro retinato anti-impurità.

1/2" washer with net filter, anti-impurity.

CR

KIT PULIZIA AERATORE - CLEANING KIT WITH AERATOR



83SET01

Set completo di 3 aeratori anticalcare M24 ad alta tecnologia + 1 chiave per la pulizia settimanale, brevettati e di lunghissima durata, il tutto in ottone e materiale plastico innovativo a forte resistenza, confezionato in un tubo contenitore rigido e trasparente adatto per essere appeso. La chiave è stata studiata per pulire il calcare dall'aeratore in un solo semplice movimento.

Set complete of 3 antilimestone M24 aerators of high technology + 1 weekly cleaning key, patented and extremely long lasting, all in brass and innovative plastic material very resistant, packed in a holding hard and transparent tube, suitable to be hung. The key has been studied to clean the aerator in one simple, easy movement.

CR



83SET02

Set completo di 2 aeratori anticalcare M24 ad alta tecnologia ed e 1 aeratore anticalcare F22 + 1 chiave per la pulizia settimanale, brevettati e di lunghissima durata, il tutto in ottone e materiale plastico innovativo a forte resistenza, confezionato in un tubo contenitore rigido e trasparente adatto per essere appeso. La chiave è stata studiata per pulire il calcare dall'aeratore in un solo semplice movimento.

Set complete of 2 antilimestone M24 aerators of high technology and 1 antilimestone F22 aerator + 1 weekly cleaning key, patented and extremely long lasting, all in brass and innovative plastic material very resistant, packed in a holding hard and transparent tube, suitable to be hung. The key has been studied to clean the aerator in one simple, easy movement.

CR

RICAMBI - SPARE PARTS



81AC

Set completo di 1 aeratore F22 anticalcare ad alta tecnologia + 1 chiave di pulizia settimanale, brevettati e di lunghissima durata, il tutto in ottone e materiale plastico innovativo a forte resistenza. L'aeratore e la chiave sono stati studiati per pulire il calcare dall'aeratore in un solo semplice movimento.

Set complete of 1 antilimestone F22 aerator of high technology + 1 weekly cleaning key, patented and extremely long lasting, all in brass and innovative plastic material very resistant. The aerator and the key has been studied to clean the aerator in one simple, easy movement.

CR



83AC

Set completo di 1 aeratore M24 anticalcare ad alta tecnologia + 1 chiave di pulizia settimanale, brevettati e di lunghissima durata, il tutto in ottone e materiale plastico innovativo a forte resistenza. L'aeratore e la chiave sono stati studiati per pulire il calcare dall'aeratore in un solo semplice movimento.

Set complete of 1 antilimestone M24 aerator of high technology + 1 weekly cleaning key, patented and extremely long lasting, all in brass and innovative plastic material very resistant. The aerator and the key has been studied to clean the aerator in one simple, easy movement.

CR

RIDUZIONI - REDUCTIONS



81RD12

Riduzione 1/2MxM22. Consente di collegare qualsiasi attacco da 1/2F", esempio tutti i flessibili doccia, con un aeratore standard lavabo/lavello F22, vedi ns articolo 81A (al posto di una doccetta o di uno shut off).

Reduction 1/2MxM22. Allows to connect any 1/2F" connection, for example all the shower flexibles, with a standard aerator basin/sink F22, see our art. 81A (instead of the classic handshower or shut-off).

CR



83RD12

Riduzione 1/2MxF24. Consente di collegare qualsiasi attacco da 1/2F", esempio tutti i flessibili doccia, con un aeratore standard lavabo M24, vedi ns articolo 83A (al posto di una doccetta o di uno shut off).

Reduction 1/2MxF24. Allows to connect any 1/2F" connection, for example all the shower flexibles, with a standard aerator basin/sink M24, see our art. 83A (instead of the classic handshower or shut-off).

CR



83RD12F22

Riduzione 1/2FxM22. Consente di collegare al lavabo/lavello F22 un qualsiasi componente con attacco 1/2M.

1/2FxM22 reduction. Connecting any component with 1/2M connection to the washbasin/sink F22.

CR



81RD12M22F

Riduzione 1/2MxF22. Consente di collegare al lavabo/lavello F22 un qualsiasi componente con attacco 1/2F.

1/2MxF22 reduction. Connecting any component with 1/2F connection to the washbasin/sink F22.

CR



83RD12M24M

Riduzione 1/2MxM24. Consente di collegare al lavabo/lavello M24 un qualsiasi componente con attacco 1/2F.

1/2MxM24 reduction. Connecting any component with 1/2F connection to the washbasin/sink M24.

CR



83RD12F24M

Riduzione 1/2FxM24. Consente di collegare al lavabo/lavello M24 un qualsiasi componente con attacco 1/2M.

1/2FxM24 reduction. Connecting any component with 1/2M connection to the washbasin/sink M24.

CR



82

Aeroflux a due getti, con doccetta a snodo, filetto F22 con riduzione M24.

Double spray aerator, with balljoint shower, thread F22 with reduction M24.

CR



82LGH

Aeroflux a due getti, con ghiera e filetto F22, lunghezza 15 cm.

Double spray aerator, with nut and thread F22, length 15 cm.

CR



82UN

Aeroflux a due getti, con doccetta a snodo, con attacco universale.

Double spray aerator, with balljoint shower, with standard connection.

CR

ECCENTRICI E DISTANZIATORI - *ECCENTRICS & CONNECTIONS*



89
Eccentrico per gruppi, 1/2x3/4, con rosone in ottone.
Eccentric unions for mixers, 1/2x3/4, with Brass flange.

CR



89L
Eccentrico per gruppi, 1/2x3/4, tipo Lusso, con rosone in ottone.
Eccentric unions for mixers, 1/2x3/4, with Brass flange, luxury type.

CR



Eccentrico per gruppi, 1/2x3/4, con rosone minimale in ottone.
Eccentric unions for mixers, 1/2x3/4, with minimal Brass flange.

89N Ø 6 cm

89NR70 Ø 7 cm



Distanziatore per gruppi, 1/2x3/4, lunghezza cm.4, 6, 8.
Brass S-connection for mixers, 1/2x3/4, length 4, 6, 8 cm.

9012344 4 cm

9012346 6 cm

9012348 8 cm

BOCCHIE - *SPOUTS*



22,5 cm



86
Canna lavello inferiore a "S", cm 22,5, tipo universale, con aeratore.
Lower "S" sink spout, cm 22,5, universal type, with aerator.

CR



20 cm



86N
Canna lavello inferiore a "S", cm 20, con aeratore.
Lower "S" sink spout, cm 20, with aerator.

CR

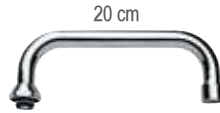

20 cm



86U
Canna lavello superiore a "U", cm 20, con aeratore.
Upper "U" sink spout, cm 20, with aerator.

CR



92U
Canna a "U" Ø 22, con aeratore.
"U" spout Ø 22, with aerator.

CR



87N
Canna a "J" per monoforo lavello, con aeratore.
"J" spout for one-hole sink mixer, with aerator.

CR



87
Canna a "J" per monoforo lavello, tipo universale, con aeratore.
"J" spout for one-hole sink mixer, universal type, with aerator.

CR



92C
Canna a biscotto a "C" con calotta da 3/4, con aeratore.
"C" spout with nut 3/4, with aerator.

CR



92CC
Canna a biscotto a "C" con calotta da 3/4, con aeratore, tipo corto.
"C" spout with nut 3/4, with aerator, short type.

CR



30 cm



93
Canna fusa lunga cm 30 con deviatore, con calotta da 3/4 ed aeratore.
Casted cm 30 long spout with diverter, with 3/4 nut, with aerator.

CR



92B
Canna a "C" con aeratore.
"C" spout with aerator.

CR



92BC
Canna a "C" corta con aeratore.
Short "C" spout with aerator.

CR

RICAMBI - SPARE PARTS



Canna a biscotto diritta, calotta da 3/4, con aeratore.
Straight spout with 3/4 nut, with aerator.

9216	16 cm
9220	20 cm
9230	30 cm
9240	40cm
9250	50 cm



Canna a biscotto a "S", calotta da 3/4, con aeratore.
"S" spout with 3/4 nut, with aerator.

92S16	16 cm
92S20	20 cm
92S30	30 cm

SCARICHI - WASTES



Tappo scarico automatico in ottone per pileta 1" e per pileta 1"1/4.
Brass plug for pop-up waste for drain 1" and for drain 1"1/4.

95TA10	1"
95TA114	1"1/4



95TAG
Tappo grande in acciaio inox per scarico automatico con pileta da 1"1/4.
Large cup in stainless steel for pop-waste, with drain 1"1/4.

CR



95TAS
Tappo grande quadrato in ottone per scarico automatico con pileta da 1"1/4.
Squared big plug in brass for pop-up waste with drain 1"1/4.

CR



96TA
Tappo in ottone per colonna vasca automatica.
Chrome plated brass plug for automatic bath waste and overflow.

CR



BAK10
Basetta in ottone per rubinetteria tipo serie Kiss, Ten, Giga.
Base in brass for mixers like serie Kiss, Ten, Giga.

CR



80SN
Morsetto con vite per scarico automatico.
Joint with screw for pop-up waste.

CR



94
Asta per scarico automatico, lunghezza cm 30, in ottone.
Rod for pop-up waste, length 30 cm, in brass.

CR



95AC
Asta e centralina bidet per scarico automatico, in ottone.
Rod and flange for bidet for pop-up automatic waste, in brass.

CR



ASX10
Asta per scarico automatico in ottone.
Rod for pop-up waste in brass.

CR



AST10

Asta con pomolo e snodino per serie Ten, in ottone.
Rod with knob and small joint for Ten series, in brass.

CR



ASK10

Asta con pomolo e snodino per serie Kiss, in ottone.
Rod with knob and small joint for Kiss series, in brass.

CR



FISW10

Confezione di fissaggio per art. W10, MC10, EY10, AU10, V10, SL10.
Fixing set for art. W10, MC10, EY10, AU10, V10, SL10.

CR



FISL72

Confezione di fissaggio per art. W72, EY72, AU72
Fixing set for art. W72, EY72, AU72.

CR



FISQK73

Confezione di fissaggio per art. L40DW
Fixing set for art. L40DW.

CR



FISQK73L

Confezione di fissaggio per art. L84, L84DJ.
Fixing set for art. L84, L84DJ.

CR



FISK10

Confezione di fissaggio per art. K10, K20, K40.
Fixing set for art. K10, K20, K40.

CR



FISR10

Confezione di fissaggio per art. R10, R20, R40.
Fixing set for art. R10, R20, R40.

CR



FISSE18

Confezione di fissaggio per art. L72U, L72C, L79DW, QD10.
Fixing set for art. L72U, L72C, L79DW, QD10.

CR



FISA10

Confezione di fissaggio per: Atmos, Flash, Qubika Cascata.
Fixing set for: Atmos, Flash, Qubika Waterfall.

CR



FISB10

Confezione di fissaggio per art. S42 U, S10 G, B10, B20, Q42U, Q10 G.
Fixing set for art. S42 U, S10 G, B10, B20, Q42U, Q10 G.

CR

DOCCHETTE CUCINA - KITCHEN HANDSHOWER



Doccetta per parrucchiere, nera.
Handshower for hairdresser, black.

- K66DONE** SENZA SCATOLA
WITHOUT BOX
- K66DONEX** CON SCATOLA
WITH BOX



Doccetta cromata per monoforo lavello.
Pull-out handshower for single-hole sink mixer.

- 331K47** SENZA SCATOLA
WITHOUT BOX
- 331K47X** CON SCATOLA
WITH BOX



Doccetta cromata per monoforo lavello, bianca.
Pull-out handshower for single-hole sink mixer, white.

- 331K47BI** SENZA SCATOLA
WITHOUT BOX
- 331K47BIX** CON SCATOLA
WITH BOX



Doccetta per monoforo lavello.
Handshower for single-hole sink mixer.

- 331** SENZA SCATOLA
WITHOUT BOX
- 331X** CON SCATOLA
WITH BOX



Doccetta cromata per monoforo lavello, a due funzioni.
Pull-out handshower for single-hole sink mixer, two functions.

- 331N82** SENZA SCATOLA
WITHOUT BOX
- 331N82X** CON SCATOLA
WITH BOX



Doccetta cromata per monoforo lavello, a due funzioni.
Pull-out handshower for single-hole sink mixer, two functions.

- 331N82C** SENZA SCATOLA
WITHOUT BOX
- 331N82CX** CON SCATOLA
WITH BOX



Doccetta cromata per monoforo lavello, a due funzioni.
Pull-out handshower for single-hole sink mixer, two functions.

- 331N83A** SENZA SCATOLA
WITHOUT BOX
- 331N83AX** CON SCATOLA
WITH BOX

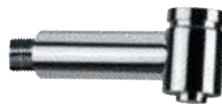

Doccetta cromata per monoforo lavello, a due funzioni.
Pull-out handshower for single-hole sink mixer, two functions.

- 331N83B** SENZA SCATOLA
WITHOUT BOX
- 331N83BX** CON SCATOLA
WITH BOX



Doccetta cromata per lavello monoforo, 2 funzione con pulsante di azionamento.
Pull-out handshower for single-hole sink mixer, 2 functions with on off botton.

- 331QK73** SENZA SCATOLA
WITHOUT BOX
- 331QK73X** CON SCATOLA
WITH BOX



Doccetta cromata per lavello monoforo, 2 funzioni.
Pull-out handshower for single-hole sink mixer, 2 functions.

- 331N85** SENZA SCATOLA
WITHOUT BOX
- 331N85X** CON SCATOLA
WITH BOX



Doccetta cromata per lavello monoforo, 2 funzioni.
Pull-out handshower for single-hole sink mixer, 2 functions.

- 331N86** SENZA SCATOLA
WITHOUT BOX
- 331N86X** CON SCATOLA
WITH BOX



Doccetta cromata per lavello monoforo, 2 funzioni.
Pull-out handshower for single-hole sink mixer, 2 functions.

- 331N87** SENZA SCATOLA
WITHOUT BOX
- 331N87X** CON SCATOLA
WITH BOX



Doccetta cromata per lavello monoforo, 1 funzione con pulsante di azionamento.
Pull-out handshower for single-hole sink mixer, 1 function with on off botton.

331V84 SENZA SCATOLA
 WITHOUT BOX

331V84X CON SCATOLA
 WITH BOX



Doccetta cromata per lavello monoforo, 2 funzioni.
Pull-out handshower for single-hole sink mixer, 2 functions.

331V84DJ SENZA SCATOLA
 WITHOUT BOX

331V84DJX CON SCATOLA
 WITH BOX



Doccetta cromata per lavello monoforo, 2 funzioni.
Pull-out handshower for single-hole sink mixer, 2 functions.

331V81M SENZA SCATOLA
 WITHOUT BOX

331V81MX CON SCATOLA
 WITH BOX



Doccetta cromata per lavello monoforo, 2 funzioni.
Pull-out handshower for single-hole sink mixer, 2 functions.

331DJN SENZA SCATOLA
 WITHOUT BOX

331DJNX CON SCATOLA
 WITH BOX



Doccetta cromata per lavello monoforo, 2 funzioni.
Pull-out handshower for single-hole sink mixer, 2 functions.

331DJC SENZA SCATOLA
 WITHOUT BOX

331DJCX CON SCATOLA
 WITH BOX



Doccetta cromata per lavello monoforo, 2 funzioni.
Pull-out handshower for single-hole sink mixer, 2 functions.

331DJD SENZA SCATOLA
 WITHOUT BOX

331DJDJX CON SCATOLA
 WITH BOX



Doccetta cromata per lavello monoforo, 1 funzione con pulsante di azionamento.
Pull-out handshower for single-hole sink mixer, 1 function with on off botton.

331N78 SENZA SCATOLA
 WITHOUT BOX

331N78X CON SCATOLA
 WITH BOX

SHUT-OFF

PLACCHE WC
 TOILET PLATES

LAVABO
 WASHBASIN

LOUNGE

FLAT

GUEST

SUITE

EPOCA

ACCESSORI
 ACCESSORIES

IDROSCOPINI
 HYDRO-BRUSH

COMPLEMENTI
 COMPL. ITEMS

RICAMBI
 SPARE PARTS

MATERIALE MARKETING MARKETING MATERIAL

ESPOSITORI DA PAVIMENTO - *FLOOR DISPLAYERS*



ESPQD2

*



ESPSLIMB

*



ESP08

*

ESPOSITORI DA PARETE - WALL DISPLAYERS

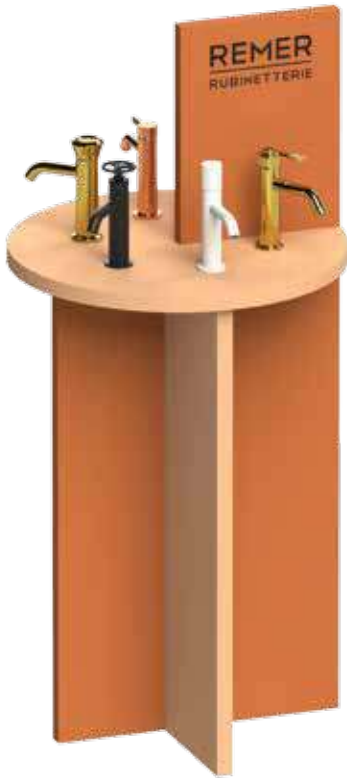

ESPFR

*



ESPACVERT

*



ESPAC

*

METRIALE MARKETING - MARKETING MATERIAL



ESP10RR

*



ESPBASCR

*



MKRBOOKFIN25

Con fotografie e campioni tattili, il book facilita la scelta della finitura più adatta, garantendo che ogni lavabo si integri armoniosamente con il design complessivo dello spazio. Questo strumento rappresenta un prezioso supporto decisionale nel processo di progettazione.

With photographs and tactile samples, the book makes it easier to choose the most suitable finish, ensuring that each sink integrates harmoniously with the overall design. This tool serves as a valuable decision-making aid in the design process.

CR

* I prodotti esposti si intendono esclusi. *Products displayed are excluded.*

LEGENDA ICONE - *ICONS LEGEND*



Acciaio INOX
Stainless Steel



Perfect Tune: Prodotto diponibile in più varianti.
Perfect Tune: Product available in different variants.

RUBINETTERIA - FAUCETS



Con scarico
With pop-up waste



Con scarico in plastica
With plastic waste



Con Click-Clack
With Click-Clak



Con Click-Clack con Troppo Pieno
With Click-Clak with Overflow



Senza Scarico
Without Waste



Eco
Eco



Cartuccia Energy Saving
Energy Saving Cartridge



Limitatore di Temperatura
Antiscalding



Risparmio Idrico Dinamico
Water Saving Dynamic



Risparmio Idrico
Water Saving



Risparmio Energetico
Energy Saving



Risparmio Idrico e Energetico
Water and Energy Saving

CUCINA - KITCHEN



Bocca Girevole
Swivel Spout



Corpo girevole
Swivel body



Doccetta Orientabile
Adjustable handshower



Doccetta Estraibile
Pull-Out Handshower



Bocca Abbattibile
Folding Spout



Doccetta a due funzioni
Two functions hand shower.



Acqua Frizzante
Sparkling Water



Acqua Potabile
Drinking Water

TECNOLOGIA - TECHNOLOGY



Touch-Me
Touch-Me



Tempor Touch
Tempor Touch



Con Luce Led
Whit Led Light



Con Batterie Alcaline Include
With Alkaline Batteries included



Alimentazione Elettrica
Power Supply



Azionamento a Sensore
Sensor Control



Con Temporizzazione per Lavatrice/Lavastoviglie
With Timing for washing/machine and Dish/Washer



Con filtro incluso
With filter included



Con Batterie al Litio Include
With Lithium Batteries included



Termostatico
Thermostatic

SOFFIONI - SHOWER HEADS



Getto effetto pioggia ad ampia copertura
Wide coverage rain effect



Getto effetto pioggia a risparmio idrico
Water-saving rain effect jet



Con Multigetto
With Multi Jet



Con Getto a Cascata
With Waterfall Jet



Getto Nebulizzato
Nebulized Jet



Cromoterapia
Colortherapy



Autopulente
Self-Cleaning



Con Getti Anticalcare
With Antilime Jets

KIT DOCCIA - SHOWER KIT



2 Vie
2 Ways



3 Vie
3 Ways



4 Vie
4 Ways



5 Vie
5 Ways



Flessibile Lungo 120 cm
Flexible Length 120 cm



Flessibile Lungo 150 cm
Flexible Length 150 cm



Flessibile Lungo 200 cm
Flexible Length 200 cm

DOCCHETTE - HANDSHOWERS



Posizione d'interruzione getto
Stop flow position



Getto intenso esterno con getto effetto pioggia interno
Intense external jet with internal rain effect jet



Getto intenso a risparmio idrico
Intense water-saving jet



Massaggio vigoroso ampia copertura effetto pioggia
Vigorous massage wide coverage rain jet



Getto vigoroso concentrato e getto esterno
Concentrated vigorous jet and external jet



Getto vigoroso concentrato
Vigorous concentrated jet



Getto Aerato Intenso
Intense Aerated Jet



Getto vigoroso effetto pioggia
Vigorous rain effect jet



Getto Vigoroso ed Ampio
Vigorous and Wide Jet



Getto spray ampia copertura e getto intenso esterno a risparmio idrico
Wide coverage spray jet and intense water saving external jet



Getto soft aerato mischiato ad un getto vigoroso a risparmio idrico
Soft aerated jet mixed with a vigorous water-saving jet



Pioggia soft a risparmio idrico
Soft rain water saving



Getto Esterno
External Jet



Con Getti Anticalcare
With Antilime Jets

COLONNE DOCCIA - SHOWER COLUMNS



Colonna Doccia Girevole
Swivable shower column



Colonna Doccia Telescopica
Telescopic shower column

CONDIZIONI GENERALI DI VENDITA

Accettazione ordini

La commissione è sempre subordinata all'approvazione della Casa Venditrice. Le condizioni di vendita si intendono accettate dal committente al momento del conferimento dell'ordine e con il ritiro del materiale.

Consegne e rese

La merce è resa franco deposito di partenza e viaggia a rischio e pericolo del committente. Il venditore si riserva di poter effettuare consegne parziali.

Spedizioni

Le quantità devono essere verificate all'atto del ricevimento ed eventuali discordanze vanno annotate sulla bolla di consegna mediante accettazione "con riserva". Eventuali spese aggiuntive per giacenze sono a carico del committente.

Imballaggio

L'imballaggio è effettuato con imballi standard ed eventualmente su pallets a carico del committente.

Termini di consegna

I termini di consegna, eventualmente indicati, sono sempre forniti a puro titolo indicativo e non vincolante.

Prezzi

I prezzi riportati nei listini non sono vincolanti. La Remer Rubinetterie S.p.A. si riserva la facoltà di variare i prezzi di vendita in qualsiasi momento senza nessun preavviso. Tutti i prezzi indicati nel catalogo sono da intendersi iva esclusa.

Pagamenti

L'eventuale ritardo del pagamento comporterà l'addebito di interessi al tasso corrente. La Remer Rubinetterie S.p.A. si riserva la facoltà di sospendere eventuali ordini in corso in presenza di pagamenti irregolari. Le contestazioni di qualsiasi valore o entità non danno diritto alla sospensione dei pagamenti.

Reclami

Non si accettano reclami o resi merce dopo 7 giorni dal ricevimento della stessa. I reclami devono pervenire entro i termini indicati tramite lettera raccomandata e via fax. Ogni reso deve essere preventivamente autorizzato dalla Remer Rubinetterie S.p.A. che fornirà istruzioni in merito.

Caratteristiche tecniche

La Remer Rubinetterie S.p.A. si riserva la facoltà di apportare ogni variazione agli articoli senza nessun preavviso.

Riservato dominio

I prodotti rimangono di proprietà della Remer Rubinetterie S.p.A. fino al totale pagamento del prezzo in conformità a quanto previsto dal C.C.

Responsabilità

La Remer Rubinetterie S.p.A. non fornisce garanzie circa l'impiego errato o inadatto dei propri prodotti. Qualora il materiale risultasse difettoso per vizi di fabbricazione riconosciuti a seguito di perizia, la Remer Rubinetterie S.p.A. si riserva di sostituirlo o accreditarne il valore senza che la propria responsabilità si possa estendere in nessun caso ad altri oneri.

Foro

Per qualsiasi controversia il Foro competente è quello di Milano.

Stampato nel mese di DICEMBRE 2024

Remer Rubinetterie S.p.A. si riserva il diritto di effettuare modifiche tecniche ed estetiche sui prodotti, senza preavviso alla clientela.

SALE CONDITIONS

Orders acceptance

The order is always subject to approval by the seller.

Delivers

The goods are delivered Ex Works and travel at the buyer's own risk. The seller reserves the right to execute partial consignments.

Forwarding

The quantities must be checked on receipt of the goods and any complaint must be made to the carrier. Any additional cost applied by the carrier will be charged to the buyer.

Packing

The goods are packed in standard packing on pallets charged to the customer.

Delivery terms

The delivery terms are always given as information and they never have to be considered as binding.

Prices

The prices shown on price list are not bending. Remer Rubinetterie S.p.A. reserves the right to modify the sales prices in any time with no prior warning. All the prices indicated in the catalog are to be considered vat excluded.

Payments

Interest at the current rate will be charged for any delays in payment. Remer Rubinetterie S.p.A. reserves the right to delete any order on hand if the payments are not correct. Any complaint of whatever type or value do not give the right to suspend payments.

Complaints

Complaints and returned goods cannot be accepted after a period of 7 days from the arrival of the goods. Complaints must be made by mean of a registered letter or by fax within the terms stated.

Any return of the goods must be authorized in advance by Remer Rubinetterie S.p.A. with instructions about it.

Technical specifications

Remer Rubinetterie S.p.A. reserves the right to carry out technical and aesthetical changes without previous notice.

Lien

The products remain the property of Remer Rubinetterie S.p.A. until the cost has been paid in full, in accordance with the provisions of the C.C.

Liability

Remer Rubinetterie S.p.A. does not provide a guarantee covering the incorrect or the inappropriate use of its products. If the material should be substandard owing to manufacturing faults which are technical inspections, Remer Rubinetterie S.p.A. reserves the right to replace the material or to credit the value to the buyer. However under no circumstance does the company's liability extend to the payment of direct or indirect charges for other things.

Competent Court of Law

For any controversy that may arise the competent court of law is the one of Milan.

Printed in DECEMBER 2024

Remer Rubinetterie S.p.A. reserves the right to introduce technical and aesthetical changes on all the articles, without previous notice to the customer.