

REMER



ACCESSORI BAGNO
BATH ACCESSORIES
COLLECTION

SHUT-OFF



SHUT-OFF



X61PW

Set per doccetta igienica shut-off con cartuccia progressiva: apertura su acqua fredda e passaggio progressivo ad acqua calda tramite rotazione del supporto. Il sistema di sicurezza integrato impedisce di aprire l'acqua quando la doccetta è inserita nel supporto e di riporre la doccetta prima di aver chiuso completamente la cartuccia. Set comprensivo di doccetta a pulsante in ottone e tubo flessibile cm 120. Cartuccia: d.25.

Set for body cleaning with progressive cartridge: opening on cold water and progressive transition to hot water by rotating the support. The integrated safety system prevents both turning on the water when the hand shower is placed in its holder and putting the hand shower back in the holder before having completely turned off the water. Set including brass shut-off hand shower and 120 cm flexible hose. Cartridge: d.25.

CR

FIN 1

FIN 2



X65C25W

Set per doccetta igienica shut-off comprensivo di miscelatore a incasso con supporto doccia e presa acqua, doccetta in ottone con apertura a pulsante, tubo flessibile 120 cm. Cartuccia d.25.

Set for body cleaning including, built-in mixer with shower holder and water intake, cylindrical brass hand shower with shut-off system, 120 cm flexible hose. Cartridge d.25.

CR

FIN 1

FIN 2

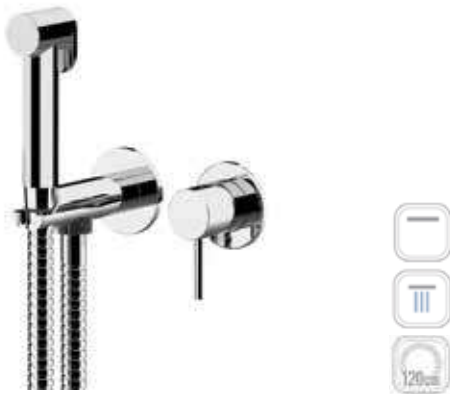

X63REWMVA

Miscelatore incasso per shut-off su piastre separate, comprensivo di doccetta shut-off art. 332OW, supporto doccia-presa acqua con valvola di sicurezza e flessibile doccia cm 120. NB: Le due parti a incasso sono indipendenti tra loro e permettono di posizionare i singoli elementi liberamente in base alle esigenze del progetto.

Built-in shower mixer set on double flange, including shut-off art. 332OW, shower holder water punch with safety valve and shower flexible cm 120. NB: The two built-in parts are independent of each other and allow the individual elements to be positioned freely according to each project needs.

CR



X65C25TW

Set per doccetta igienica shut-off comprensivo di miscelatore a incasso con leva minimale e presa acqua esterna, mensola portaoggetti integrata 100x210mm con supporto per doccetta, doccetta a pulsante in ottone, tubo flessibile 120cm.

Set for body cleaning including built-in mixer with minimal lever and external water connection, 100x210mm shelf with hand shower holder, brass hand shower with shut-off system, 120cm flexible hose.

CR

SHUT-OFF PROGRESSIVO - PROGRESSIVE SHUT-OFF



Q64

Miscelatore shut-off quadrato con cartuccia progressiva, apertura su acqua fredda e passaggio ad acqua calda tramite rotazione di maniglia unica, comprensivo di doccetta shut-off 332OS e flessibile cm 120.

Shut-off square mixer with progressive cartridge, opening with cold water, switching on hot water by rotating one single handle including shut-off 332OS and flexible hose 120 cm.

CR

FIN 1

FIN 2



N64W

Miscelatore shut-off serie Minimal con cartuccia progressiva, apertura su acqua fredda e passaggio ad acqua calda tramite rotazione di maniglia unica, comprensivo di doccetta shut-off 332OW e flessibile cm 120.

Shut-off mixer Minimal series with progressive cartridge, opening with cold water, switching on hot water by rotating one single handle including shut-off 332OW and flexible hose 120 cm.

CR

FIN 1

FIN 2

SHUT-OFF

PLACCHE WC
TOILET PLATES

LAVABO
WASHBASIN

LOUNGE

FLAT

GUEST

SUITE

EPOCA

ACCESSORI
ACCESSORIES

IDROSCOPINI
HYDRO-BRUSH

COMPLEMENTI
COMPL. ITEMS

RICAMBI
SPARE PARTS

MISCELATORI INCASSO - BUILT-IN MIXERS



N63
Miscelatore incasso per shut-off.
Built-in shut-off mixer.

CR



Z63
Miscelatore incasso per shut-off.
Built-in shut-off mixer.

CR



L63
Miscelatore incasso per shut-off.
Built-in shut-off mixer.

CR



Q63
Miscelatore incasso per shut-off.
Built-in shut-off mixer.

CR



S633
Miscelatore incasso per shut-off.
Built-in shut-off mixer.

CR

MISCELATORI SHUT-OFF - SHUT-OFF MIXERS



D60
Miscelatore incasso shut-off serie Dream
comprensivo di: doccetta shut-off 332OL,
supporto doccia presa acqua su piastra in ottone
e flessibile cm 120.
*Built-in shower mixer set Dream series including:
shut-off 332OL, shower holder water punch on
flange all in brass and flexible hose cm 120.*

CR



N60
Miscelatore incasso shut-off serie Minimal
comprensivo di: doccetta shut-off 332OL,
supporto doccia presa acqua su piastra in ottone
e flessibile cm 120.
*Built-in shut-off mixer set Minimal series including:
shut-off 332OL, shower holder water punch on
flange, all in brass and flexible hose cm 120.*

CR



I60
Miscelatore incasso shut-off serie Infinity
comprensivo di: doccetta shut-off 332OL,
supporto doccia presa acqua su piastra in ottone
e flessibile cm 120.
*Built-in shut-off mixer set Infinity series including:
shut-off 332OL, shower holder water punch on
flange, all in brass and flexible hose cm 120.*

CR



D60W
Miscelatore incasso shut-off serie Dream
comprensivo di: doccetta shut-off 332OW,
supporto doccia presa acqua su piastra in ottone
e flessibile cm 120.
*Built-in shower mixer set Dream series including:
shut-off 332OW, shower holder water punch on
flange all in brass and flexible hose cm 120.*

CR



N60W
Miscelatore incasso shut-off serie Minimal
comprensivo di: doccetta shut-off 332OW,
supporto doccia presa acqua su piastra in ottone
e flessibile cm 120.
*Built-in shut-off mixer set Minimal series including:
shut-off 332OW, shower holder water punch on
flange, all in brass and flexible hose cm 120.*

CR



I60W
Miscelatore incasso shut-off serie Infinity
comprensivo di: doccetta shut-off 332OW,
supporto doccia presa acqua su piastra in ottone
e flessibile cm 120.
*Built-in shower mixer set Infinity series including:
shut-off 332OW, shower holder water punch on
flange, all in brass and flexible hose cm 120.*

CR



S603

Miscelatore incasso shut-off serie SQ3 comprensivo di: doccetta shut-off 332OS, supporto doccia presa acqua su piastra in ottone e flessibile cm 120.

Built-in shut-off mixer set SQ3 series including: shut-off 332OS, shower holder water punch on flange, all in brass and flexible hose cm 120.

CR



Z60

Miscelatore incasso shut-off serie Flash comprensivo di: doccetta shut-off 332OS, supporto doccia presa acqua su piastra in ottone e flessibile cm 120.

Built-in shut-off mixer set Flash series including: shut-off 332OS, shower holder water punch on flange, all in brass and flexible hose cm 120.

CR



Q60

Miscelatore incasso shut-off serie Qubika comprensivo di: doccetta shut-off 332OS, supporto doccia presa acqua su piastra in ottone e flessibile cm 120.

Built-in shut-off mixer set Qubika series including: shut-off 332OS, shower holder water punch on flange, all in brass and flexible hose cm 120.

CR



W65

Miscelatore incasso per shut-off serie Winner comprensivo di doccetta shut-off 332OL, supporto doccia-presa acqua, attacco conico da 1/2" e supporto shut-off, tutto in ottone, flessibile cm 120.

Built-in shower mixer set Winner series including: shut-off 332OL, shower holder water punch on flange, all in brass, with 1/2 connection, handshower support and flexible hose cm 120.

CR



W65W

Miscelatore incasso per shut-off serie Winner comprensivo di doccetta shut-off 332OW, supporto doccia-presa acqua, attacco conico da 1/2" e supporto shut-off, tutto in ottone, flessibile cm 120.

Built-in shower mixer set Winner series including: shut-off 332OW, shower holder water punch on flange, all in brass, with 1/2 connection, handshower support and flexible hose cm 120.

CR



W65B

Miscelatore incasso per shut-off serie Winner su piastra in ottone, attacco conico da 1/2" e supporto shut-off.

Built-in shut-off mixer Winner series all in brass with 1/2 connection and handshower support.

CR



I65

Miscelatore incasso shut-off serie Infinity comprensivo di doccetta shut-off 332OL, supporto doccia-presa acqua, attacco conico da 1/2" e supporto shut-off, tutto in ottone, flessibile cm 120.

Built-in shower mixer set Infinity series including: shut-off 332OL, shower holder water punch on flange, all in brass, with 1/2 connection, handshower support and flexible hose cm 120.

CR



I65W

Miscelatore incasso shut-off serie Infinity comprensivo di doccetta shut-off 332OW, supporto doccia-presa acqua, attacco conico da 1/2" e supporto shut-off, tutto in ottone, flessibile cm 120.

Built-in shower mixer set Infinity series including: shut-off 332OW, shower holder water punch on flange, all in brass, with 1/2 connection, handshower support and flexible hose cm 120.

CR



I65B

Miscelatore incasso per shut-off serie Infinity su piastra in ottone, attacco conico da 1/2" e supporto shut-off.

Built-in shut-off mixer Infinity series all in brass with 1/2 connection and handshower support.

CR

SHUT-OFF

PLACCHE WC
TOILET PLATES

LAVABO
WASHBASIN

LOUNGE

FLAT

GUEST

SUITE

EPOCA

ACCESSORI
ACCESSORIES

IDROSCOPINI
HYDRO-BRUSH

COMPLEMENTI
COMPL. ITEMS

RICAMBI
SPARE PARTS

SHUT-OFF



L65

Miscelatore incasso shut-off serie Class Line comprensivo di doccetta shut-off 332OL, supporto doccia-presa acqua, attacco conico da 1/2" e supporto shut-off, tutto in ottone, flessibile cm 120.
Built-in shower mixer set Class Line series including: shut-off 332OL, shower holder water punch on flange, all in brass, with 1/2 connection, handshower support and flexible hose cm 120.

CR



L65W

Miscelatore incasso shut-off serie Class Line comprensivo di doccetta shut-off 332OW, supporto doccia-presa acqua, attacco conico da 1/2" e supporto shut-off, tutto in ottone, flessibile cm 120.

Built-in shower mixer set Class Line series including: shut-off 332OW, shower holder water punch on flange, all in brass, with 1/2 connection, handshower support and flexible hose cm 120.

CR



L65B

Miscelatore incasso per shut-off serie Class Line su piastra in ottone, attacco conico da 1/2" e supporto shut-off.

Built-in shut-off mixer Class Line series all in brass with 1/2 connection and handshower support.

CR



D65

Miscelatore incasso shut-off serie Dream comprensivo di doccetta shut-off 332OL, supporto doccia-presa acqua, attacco conico da 1/2" e supporto shut-off, tutto in ottone, flessibile doccia cm 120.

Built-in shower mixer set Dream series including: shut-off 332OL, shower holder water punch on flange, all in brass, with 1/2 connection, handshower support and flexible hose cm 120.

CR



D65W

Miscelatore incasso shut-off serie Dream comprensivo di doccetta shut-off 332OW, supporto doccia-presa acqua, attacco conico da 1/2" e supporto shut-off, tutto in ottone, flessibile doccia cm 120.

Built-in shower mixer Dream series set including: shut-off 332OW, shower holder water punch on flange, all in brass, with 1/2 connection, handshower support and flexible hose cm 120.

CR



D65B

Miscelatore incasso per shut-off serie Dream su piastra in ottone, attacco conico da 1/2" e supporto shut-off.

Built-in shut-off mixer Dream series all in brass with 1/2 connection and handshower support.

CR



N65

Miscelatore incasso shut-off serie Minimal comprensivo di doccetta shut-off 332OL, supporto doccia presa acqua, attacco conico da 1/2" e supporto shut-off, tutto in ottone, flessibile cm 120.
Built-in shower mixer set Minimal series including shut-off 332OL, shower holder water punch on flange, all in brass, with 1/2 connection, handshower support and flexible hose cm 120.

CR



N65W

Miscelatore incasso shut-off serie Minimal comprensivo di doccetta shut-off 332OW, supporto doccia-presa acqua, attacco conico da 1/2" e supporto shut-off, tutto in ottone, flessibile doccia cm 120.

Built-in shower mixer set Minimal series including: shut-off 332OW, shower holder water punch on flange, all in brass, with 1/2 connection, handshower support and flexible hose cm 120.

CR



N65B

Miscelatore incasso per shut-off serie Minimal su piastra in ottone, attacco conico da 1/2" e supporto shut-off.

Built-in shut-off mixer Minimal series all in brass with 1/2 connection and handshower support.

CR



N65SW

Miscelatore incasso shut-off serie Minimal con leva corta, comprensivo di doccetta shut-off 332OW, supporto doccia-presa acqua, attacco conico da 1/2" e supporto shut-off, tutto in ottone, flessibile cm 120.

Built-in shower mixer Minimal series set with short lever, including: shut-off 332OW, shower holder water punch on flange, all in brass, with 1/2 connection, handshower support and flexible hose cm 120.

CR



X65W

Miscelatore incasso shut-off serie X Style comprensivo di doccetta shut-off 332OW, supporto doccia-presa acqua, attacco conico da 1/2" e supporto shut-off, tutto in ottone, flessibile cm 120.

Built-in shower mixer X Style series set including: shut-off 332OW, shower holder water punch on flange, all in brass, with 1/2 connection, handshower support and flexible hose cm 120.

CR



X65B

Miscelatore incasso per shut-off serie X Style su piastra in ottone, attacco conico da 1/2" e supporto shut-off.

Built-in shut-off mixer X Style series all in brass with 1/2 connection and handshower support.

CR



V65W

Miscelatore incasso shut-off serie Vanity comprensivo di doccetta shut-off 332OW, supporto doccia-presa acqua, attacco conico da 1/2" e supporto shut-off, tutto in ottone, flessibile cm 120.

Built-in shower mixer Vanity series set including: shut-off 332OW, shower holder water punch on flange, all in brass, with 1/2 connection, handshower support and flexible hose cm 120.

CR



V65B

Miscelatore incasso per shut-off serie Vanity su piastra in ottone, attacco conico da 1/2" e supporto shut-off.

Built-in shut-off mixer Vanity series all in brass with 1/2 connection and handshower support.

CR



Q65

Miscelatore incasso shut-off serie Qubika comprensivo di doccetta shut-off 332OS, supporto doccia-presa acqua, attacco conico da 1/2" e supporto shut-off, tutto in ottone, flessibile cm 120.

Built-in shower mixer Qubika series set including: shut-off 332OS, shower holder water punch on flange, all in brass, with 1/2 connection, handshower support and flexible hose cm 120.

CR



Q65B

Miscelatore incasso per shut-off serie Qubika su piastra in ottone, attacco conico da 1/2" e supporto shut-off.

Built-in shut-off mixer Qubika series all in brass with 1/2 connection and handshower support.

CR

**SHUT-OFF TERMOSTATICO
THERMOSTATIC SHUT-OFF**



NT60W

Miscelatore incasso per shut-off serie Minimal Thermo comprensivo di: doccetta shut-off 332OW, supporto doccia presa acqua su piastra in ottone e flessibile cm 120.

Built-in shut-off mixer set Minimal Thermo series including: shut-off 332OW, shower holder water punch on flange, all in brass and flexible hose cm 120.

CR

SHUT-OFF

PLACCHE WC
TOILET PLATES

LAVABO
WASHBASIN

LOUNGE

FLAT

GUEST

SUITE

EPOCA

ACCESSORI
ACCESSORIES

IDROSCOPINI
HYDRO-BRUSH

COMPLEMENTI
COMPL. ITEMS

RICAMBI
SPARE PARTS

MISCELATORI CON DEVIAZIONE INTEGRATA PER SHUT-OFF
MIXERS WITH INTEGRATED DIVERTER FOR SHUT-OFF



L10SHW

Miscelatore monocomando lavabo serie Class Line con doccetta shut-off 332OW e scarico click-clack con troppo pieno.
Single-lever basin mixer Class Line series with handshower shut-off 332OW and click-clack waste with overflow.

CR

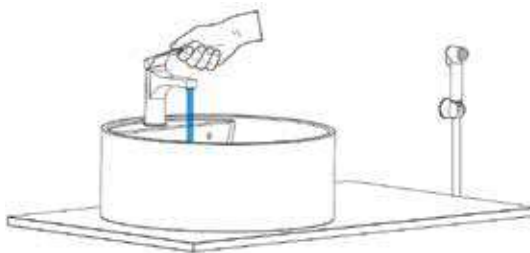

1

ALZANDO LA LEVA AZIONIAMO IL FLUSSO D'ACQUA DEL MISCELATORE.
BY LIFTING THE LEVER WE OPEN THE WATER FLOW OF THE MIXER.



2

SCHIACCIANDO IL PULSANTE DEVIAMO IL FLUSSO D'ACQUA ALLA DOCCETTA.
BY PUSHING THE BUTTON WE DIVERT THE WATER FLOWING TO THE HAND SHOWER.

MISCELATORI SHUT-OFF CONN INTERASSE 100MM
SHUT-OFF MIXERS WITH INTERAXIS 100MM



LC31DP

Miscelatore monocomando esterno doccia serie Class Line, interasse 100 mm, con kit composto da doccetta shut-off in ABS cromato 332DPCR, flessibile conico in ottone 120 cm e gancio cromato 332GA.

Wall mounted single lever shower mixer Class Line series, interaxis 100 mm with kit including: shut-off handshower in c.p. ABS 332DPCR, conical flexible hose in brass cm 120 and c.p. hook 332GA.

CR



IC31REW

Miscelatore monocomando esterno doccia serie Infinity, interasse 100 mm, con kit composto da doccia a pulsante 332OW, flessibile conico 120 cm e supporto 339SO in ottone.

Wall mounted single lever shower mixer Infinity series, interaxis 100 mm, with kit including: shut-off handshower 332OW, conical flexible hose cm 120 and shower holder 339SO.

CR



WC31DP

Miscelatore monocomando esterno doccia serie Winner, interasse 100 mm, con kit composto da doccetta shut-off in ABS cromato 332DPCR, flessibile conico in ottone 120 cm e gancio cromato 332GA.

Wall mounted single lever shower mixer Winner series, interaxis 100 mm, with kit composed of shut-off handshower in c.p. ABS 332DPCR, conical flexible hose in brass cm 120 and c.p. hook 332GA.

CR

LC31

Miscelatore monocomando esterno doccia serie Class Line, interasse 100 mm, senza kit doccia.
Wall mounted single lever shower mixer Class Line series, interaxis 100 mm without shower set.

CR

IC31

Miscelatore monocomando esterno doccia serie Infinity, interasse 100 mm, senza kit doccia.
Wall mounted single lever shower mixer Infinity series, interaxis 100 mm without shower set.

CR

WC31

Miscelatore monocomando esterno doccia serie Winner, interasse 100 mm, senza kit doccia.
Wall mounted single lever shower mixer Winner series, interaxis 100 mm without shower set.

CR



C332REL

Set "Relax" composto da: doccia a pulsante 332OL, flessibile conico 120 cm, miscelatore doccia serie Cento C33 interasse 100 mm e supporto "lux" in ottone.

"Relax" set including: shut-off handshower 332OL, conical flexible hose cm 120, shower mixer serie Cento C33 interaxis 100 mm and brass "Lux" shower holder.

CR



C332REZ

Set "Relax" composto da: doccia a pulsante 332OZ, flessibile conico 120 cm, miscelatore doccia serie Cento C33 interasse 100 mm e supporto "lux" in ottone.

"Relax" set including: shut-off handshower 332OZ, conical flexible hose cm 120, shower mixer serie Cento C33 interaxis 100 mm and brass "Lux" shower holder.

CR



C332RELA

Set "Relax" composto da: doccia a pulsante 332OLA, flessibile conico 120 cm, miscelatore doccia serie Cento C33 interasse 100 mm e supporto "lux" in ottone.

"Relax" set including: shut-off handshower 332OLA, conical flexible hose cm 120, shower mixer serie Cento C33 interaxis 100 mm and brass "Lux" shower holder.

CR



C332DP

Esterno doccia con leva frontale, interasse 100 mm, doccetta shut-off in ABS cromato e flessibile da 120 cm.

Wall mounted single-lever shower mixer, interaxis 100 mm, with frontal lever, with handshower shut-off in c.p. ABS and flexible hose 120 cm.

CR



C312DP

Esterno doccia, interasse 100 mm, doccetta shut-off in ABS cromato e flessibile da 120 cm.

Wall mounted single-lever shower mixer interaxis 100 mm, with handshower shut-off in c.p. ABS and flexible hose 120 cm.

CR



C312REL

Esterno doccia, interasse 100 mm, doccetta shut-off in ottone e flessibile da 120 cm.

Wall mounted single-lever shower mixer interaxis 100 mm, with handshower shut-off in brass and flexible hose 120 cm.

CR



C312RELA

Esterno doccia, interasse 100 mm, doccetta shut-off in ottone e flessibile da 120 cm.

Wall mounted single-lever shower mixer interaxis 100 mm, with handshower shut-off in brass and flexible hose 120 cm.

CR

SHUT-OFF MONOACQUA - SINGLE WATER SHUT-OFF

**332REL336**

Set composto da: doccia a pulsante 332OL, flessibile con attacco conico cm 120, rubinetto d'arresto con supporto doccia in ottone.

Set including: shut-off handshower 332OL, flexible hose cm 120, brass round angle valve with shower holder.

CR

**332RES336**

Set composto da: doccia a pulsante quadrata 332OS, flessibile con attacco conico cm 120, rubinetto d'arresto con supporto doccia in ottone.

Set including: shut-off handshower 332OS, flexible hose cm 120, brass squared angle valve with shower holder.

CR

**332REW336**

Set quadrato composto da: doccia a pulsante 332OW, flessibile con attacco conico cm 120, rubinetto d'arresto con supporto doccia in ottone.

Squared set including: shut-off handshower 332OW, flexible hose cm 120, brass round angle valve with shower holder.

CR

**332RELA336**

Set composto da: doccia a pulsante 332OLA (compreso di aeratore e chiave 83AC), flessibile con attacco conico cm 120, rubinetto d'arresto con supporto doccia in ottone.

Set including: shut-off handshower 332OLA (complete of aerator and key kit 83AC), flexible hose cm 120, brass squared angle valve with shower holder.

CR

**332REZ336**

Set composto da: doccia a pulsante con impugnatura zigrinata 1/2" 332OZ, flessibile con attacco conico cm 120, rubinetto d'arresto, con supporto doccia in ottone.

Set including: shut-off handshower with knurled handgrip 1/2" 332OZ, flexible hose cm 120, brass round angle valve with shower holder.

CR

**332REU336**

Set composto da: doccia a pulsante minimale in ABS cromata 332EU, flessibile con attacco conico cm 120, rubinetto d'arresto, con supporto doccia in ottone.

Set including: shut-off ABS minimal handshower 332EU, flexible hose cm 120, brass squared angle valve with shower holder.

CR

**332REL129**

Set "Relax" composto da: doccia a pulsante 332OL, flessibile conico 120 cm, rubinetto sottolavabo art. 129 e supporto "Lux" in ottone.

"Relax" set including: shut-off handshower 332OL, conical flexible hose 120 cm, angle valve art. 129 and "Lux" brass shower holder.

CR

**332REZ129**

Set "Relax" composto da: doccia a pulsante 332OZ, flessibile conico 120 cm, rubinetto sottolavabo art. 129 e supporto "Lux" in ottone.

"Relax" set including: shut-off handshower 332OZ, conical flexible hose 120 cm, angle valve art. 129 and "Lux" brass shower holder.

CR



338M332OL

Set composto da: doccetta a pulsante, flessibile con attacco conico cm 120, rubinetto ad angolo Minimal con vitone ceramico e supporto doccia "Lux" in ottone.
 Set composed of: shut-off handshower, cm 120 flexible hose with one conical nut, angle valve serie "Minimal" with ceramic headwork and "Lux" brass shower holder.

CR



338M332OW

Set composto da: doccetta a pulsante, flessibile con attacco conico cm 120, rubinetto ad angolo Minimal con vitone ceramico e supporto doccia "Lux" in ottone.
 Set composed of: shut-off handshower, cm 120 flexible hose with one conical nut, angle valve serie "Minimal" with ceramic headwork and "Lux" brass shower holder.

CR

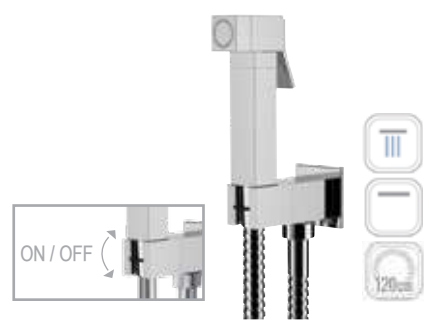

338Q332OS

Set composto da: doccetta a pulsante, flessibile con attacco conico cm 120, rubinetto ad angolo SQ con vitone ceramico e supporto doccia "Lux" in ottone.
 Set composed of: shut-off handshower, cm 120 flexible hose with one conical nut, angle valve serie "SQ" with ceramic headwork and "Lux" brass shower holder.

CR



332RELA

Set "Relax", composto da: doccia a pulsante 332OLA (compresa di aeratore e chiave 83AC), flessibile conico 120 cm, supporto "Lux" in ottone, con rubinetto sottolavabo "Minimal" e vitone ceramico.

"Relax" set including: shut-off handshower 332OLS (complete of aerator and key kit 83AC), conical flexible hose 120 cm, "Lux" brass shower holder, with "Minimal" angle valve and ceramic headwork.

CR



332REZ

Set "Relax", composto da: doccia a pulsante 332OZ, flessibile conico 120 cm, supporto "Lux" in ottone, con rubinetto sottolavabo "Minimal" e vitone ceramico.

"Relax" set including: shut-off handshower 332OZ, conical flexible hose cm, "Lux" brass shower holder, with "Minimal" angle valve and ceramic headwork.

CR



332RES

Set "Relax SQ" composto da: doccia quadrata a pulsante 332OS, flessibile conico 120 cm, supporto "Lux" in ottone, con rubinetto sottolavabo "SQ" con vitone ceramico.

"Relax SQ" set, including: "SQ" shut-off handshower 332OS, conical flexible hose 120 cm, "Lux" brass shower holder, with "SQ" angle valve with ceramic headwork.

CR

332332OLA

senza rubinetto sottolavabo.
 without angle valve.

CR

332332OZ

senza rubinetto sottolavabo.
 without angle valve.

CR

332332OS

senza rubinetto sottolavabo.
 without angle valve.

CR

SHUT-OFF

PLACCHE WC
 TOILET PLATES

LAVABO
 WASHBASIN

LOUNGE

FLAT

GUEST

SUITE

EPOCA

ACCESSORI
 ACCESSORIES

IDROSCOPINI
 HYDRO-BRUSH

COMPLEMENTI
 COMPL. ITEMS

RICAMBI
 SPARE PARTS

SHUT-OFF



332EURM

Set "Eurolux" composto da: doccia a pulsante minimale in ABS cromata 332EU, flessibile conico metallizzato 120 cm, supporto in ABS, con rubinetto sottolavabo Minimal con vitone ceramico.

"Eurolux" set including: shut-off handshower minimal in c.p. ABS 332EU, conical metallized flexible hose cm 120, ABS shower holder, with Minimal angle valve with ceramic headvalve.

CR

332332EUM

senza rubinetto sottolavabo.
without angle valve.

CR



332REL

Set "Relax", composto da: doccia a pulsante 332OL, flessibile conico 120 cm, supporto "Lux" in ottone, con rubinetto sottolavabo Minimal con vitone ceramico.

"Relax" set including: shut-off handshower 332OL, conical flexible hose 120 cm, "Lux" brass shower holder, with Minimal angle valve with ceramic headvalve.

CR

332332OL

senza rubinetto sottolavabo.
without angle valve.

CR



332REW

Set "Relax", composto da: doccia a pulsante 332OW, flessibile conico 120 cm, supporto "Lux" in ottone, con rubinetto sottolavabo Minimal in ottone con vitone ceramico.

"Relax" set including: shut-off handshower 332OW, conical flexible hose 120 cm, "Lux" brass shower holder, with angle valve in brass serie Minimal and with ceramic headwork.

CR

332332OW

senza rubinetto sottolavabo.
without angle valve.

CR



332RERCR

doccia a pulsante cromata 332ORCR, flessibile conico 120 cm e supporto cromato 339 F, con rubinetto sottolavabo in ottone.

chrome plastic shut-off handshower 332ORCR, conical flexible hose cm 120, and chrome shower support 339 F, with angle valve in brass.

CR

332332ORCR

senza rubinetto sottolavabo.
without angle valve.

CR



332DPRR

Set "Eco" composto da: doccia a pulsante bianca 332DPR, flessibile retinato 120 cm e gancio bianco 332GA, con rubinetto sottolavabo in ottone.

"Eco" set including: white plastic shut-off handshower 332DPR, net worked flexible hose cm 120 and white hook 332GA, with angle valve in brass.

CR

33212

senza rubinetto sottolavabo.
without angle valve.

CR



332DCR

Set "Eco" composto da: doccia a pulsante cromata 332DPCR, flessibile cromato 120 cm e gancio cromato 332GA, con rubinetto sottolavabo in ottone.

"Eco" set including: c.p. plastic shut-off handshower 332DPCR, conical brass flexible hose cm 120 and c.p. hook 332GA, with angle valve in brass.

CR

332332DCR

senza rubinetto sottolavabo.
without angle valve.

CR



332RER

Set composto da: doccia a pulsante bianca 332 OR, flessibile retinato 120 cm e supporto bianco 339 F BI, con rubinetto sottolavabo in ottone.

Set including: white plastic shut-off handshower 332 OR, net worked flexible hose cm 120 and white shower support 339 F BI, with angle valve in brass.

CR



332TEL

Set composto da: doccia a pulsante, flessibile conico 120 cm, rubinetto temporizzato 1/2" in ottone tempo di apertura 6-8 secondi.

Set including: shut-off handshower, flexible cm 120, temporized button flusher 1/2" all in Brass, opening time 6-8 seconds.

CR



332RGRR

Set composto da flessibile retinato bianco cm 120, rompigitto con gancio, appendino, rubinetto sottolavabo.

Set including: shower flexible in white net working cm 120, jet breaker with holder, hook, angle valve.

CR

332332OR

senza rubinetto sottolavabo.
without angle valve.

CR



332RGRE120

Set composto da flessibile retinato bianco cm 120, rompigitto con gancio, appendino.

Set including: white shower flexible hose net working cm 120, jet breaker with shower holder, hook.

CR



332RG

Rompigitto in ABS cromato con anello per attacco a muro.

C.p. ABS flow regulator with ring for wall connection.

CR



81RD12

Riduzione 1/2MxM22 di collegamento flessibile doccia con aeratore F22 (nostro art. 81).
Reduction 1/2MxM22 to connect the shower flexible to F22 aerator (our article 81).

CR



332GA

Appendino in ABS cromato.
C.p. ABS hook.

CR



332GABI

Appendino in ABS bianco.
White ABS hook.

CR



81

Aeratore classico con retine in inox, per gruppo lavello F22.
Classic aerator with inox nets, for sink spout F22.

CR

DOCCETTE SHUT-OFF IN OTTONE - SHUT-OFF HANDSHOWER IN BRASS



Doccetta a pulsante quadrata, in ottone, 1/2".
Brass squared shut-off, with plain handgrip, 1/2"

332OS

Senza scatola - Without box

CR

**332OSX**

Con scatola - With box

CR

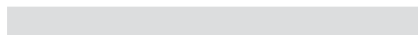

Doccetta a pulsante "Lux" in ottone, con impugnatura liscia 1/2".
Brass shut-off "Lux" handshower with plain handgrip, 1/2"

332OL

Senza scatola - Without box

CR

**332OLX**

Con scatola - With box

CR

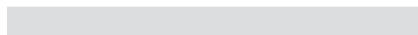

Doccetta a pulsante "Lux" in ottone, con impugnatura zigrinata 1/2".
Brass shut-off "Lux" handshower with knurled handgrip, 1/2"

332OZ

Senza scatola - Without box

CR

**332OZX**

Con scatola - With box

CR

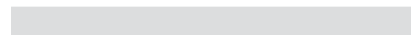

Doccetta a pulsante "Lux" in ottone, con impugnatura bombata 1/2".
Brass shut-off "Lux" handshower with convex handgrip, 1/2"

332OB

Senza scatola - Without box

CR

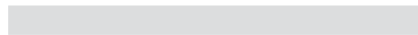
**332OBX**

Con scatola - With box

CR



Doccetta a pulsante "Lux" in ottone, con impugnatura liscia da 1/2" completa di kit aeratore con chiave 83AC, nuovo sistema brevettato ad alta tecnologia per la pulizia dell'aeratore e di lunghissima durata.
Brass shut-off "Lux" handshower, with plain handgrip, 1/2" complete with aerator and key kit 83AC, new Patented system of high technology for the cleaning of the aerator, extremely long lasting.

332OLA

Senza scatola - Without box

CR

**332OLAX**

Con scatola - With box

CR

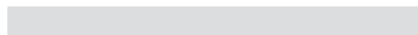

Doccetta a pulsante "Lux" minimale in ottone, con impugnatura liscia 1/2".
Minimal Brass shut-off "Lux" handshower with plain handgrip, 1/2"

332OW

Senza scatola - Without box

CR

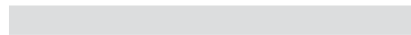
**332OWX**

Con scatola - With box

CR

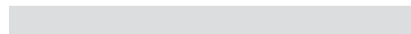

DOCLETTE SHUT-OFF IN ABS - SHUT-OFF HANDSHOWER IN ABS



332DPCR
Doccetta a pulsante, 1/2 cromata.
C.P. shut-off, 1/2.

CR



332DPBN
Doccetta a pulsante, 1/2 bianca.
White shut-off, 1/2.

CR



332ORCR
Doccetta shut-off cromata in ABS stampata made in italy.
Chrome ABS shut off handshower printed made in italy.

CR



332LUCR
Doccetta a pulsante, 1/2 cromata.
C.P. shut-off, 1/2

CR



332OR
Doccetta shut-off bianca in ABS stampata made in italy.
White ABS shut off handshower printed made in italy.

CR



332ORNE
Doccetta shut-off nera in ABS stampata made in italy.
Black ABS shut off handshower printed made in italy.

CR



Doccetta a pulsante minimale in ABS cromata con impugnatura liscia, 1/2".
C.p. ABS minimal shut-off, with plain handgrip, 1/2".

332EU Senza scatola - Without box
CR

332EUX Con scatola - With box
CR

SHUT-OFF

PLACCHE WC
TOILET PLATES

LAVABO
WASHBASIN

LOUNGE

FLAT

GUEST

SUITE

EPOCA

ACCESSORI
ACCESSORIES

IDROSCOPINI
HYDRO-BRUSH

COMPLEMENTI
COMPL. ITEMS

RICAMBI
SPARE PARTS

PLACCHE WC TOILET PLATES



RB810CR

Scopri la nostra gamma di placche WC, progettate per unire estetica e praticità. Offriamo due forme distintive: quadrata e tonda, per adattarsi perfettamente a qualsiasi bagno.

Discover our range of WC plates designed to combine aesthetics and practicality. We offer two distinctive shapes: square and round, perfectly suited for any bathroom.

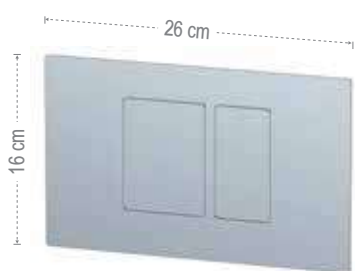

RB820CR

Piastra WC con pulsanti rettangolari.
Toilet flush plate with rectangular buttons.

CR NO - BO BG DO INOX



RB810CR

Piastra WC con pulsanti tondi.
Toilet flush plate with rounded buttons.

CR NO - BO BG DO INOX

COMPATIBILITÀ CON : - COMPATIBILITY WITH :

Geberit	Tece	Viega	Oil
SIGMA 8 CM SIGMA 12 CM	2003-2020 2021-NOW	3H - 3L - 3F	74 PLUS 120 PLUS EXPERT PLUS QUADRA PLUS



NO



RB820NO
Nero opaco
Matt black



RB810NO
Nero opaco
Matt black

BO



RB820BO
Bianco opaco
Matt white



RB810BO
Bianco opaco
Matt white

INOX



SSRB820
Visual inox
Visual steel



SSRB810
Visual inox
Visual steel



BG



RB820BG
Oro Spazzolato
Brushed Gold



RB810BG
Oro Spazzolato
Brushed Gold

DO



RB820DO
Oro Lucido
Shiny Gold



RB810DO
Oro Lucido
Shiny Gold

LAVABO WASHBASIN



RB902BG

Con linee essenziali e materiali di alta qualità, questo lavabo è disponibile in varie finiture, perfetto per chi desidera uno stile elegante e pratico in bagno.

With clean lines and high-quality materials, this sink is available in various finishes, perfect for those who desire both elegance and practicality in the bathroom.



RB902DO
Oro Lucido
Shiny Gold



RB902BG
Oro Spazzolato
Brushed Gold



RB902CFP
Cromo Nero Spazzolato
Brushed Black Chrome



RB902RP
Rame Spazzolato
Brushed Copper

FIN 2



RB902CR

Lavabo da appoggio rotondo, con ceramica bianca e fascia in finitura a scelta.
Round countertop washbasin with white ceramic and band in your choice of finish.

CR

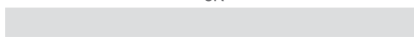

NO

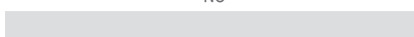

INOX

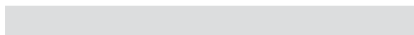

FIN 2

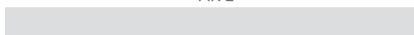

RB902NO
Nero opaco
Matt black

NO



SSRB902
Visual inox
Visual steel

INOX



RB902RP

LOUNGE



LN13CR



LN13CR
Dispenser per sapone liquido in vetro satinato con supporto in ottone.
Satin glass soap dispenser with cp brass support.

CR



LN15CR
Portabicchiere in ottone con bicchiere in vetro satinato.
Cp brass cup holder with satin glass.

CR



LN10CR
Portasapone in vetro satinato con supporto in ottone.
Satin glass soap dish holder with cp brass support.

CR



LN50CR
Appendino in ottone.
Cp brass hook.

CR



LN44CR
Portasalviette in ottone, 23,6x70 mm.
Cp brass towel holder 23,6x70 mm.

CR



LN60CR
Portarotolo in ottone.
Cp brass toilet paper holder.

CR



LN61CR
Portarotolo di ricambio in ottone.
Brass spare toilet paper holder.

CR



LN20CR

Mensola in ottone, dimensione 13x51 cm.
Cp brass shelf, dimensions 13x51 cm.

CR



LN33CR

Portasalviette doppio in ottone, lunghezza cm 60.
Cp brass double towel holder, length cm 60.

CR



LN30CR

Portasalviette in ottone, lunghezza cm 60.
Cp brass towel holder, length cm 60.

CR



LN40CR

Portasalviette in ottone, lunghezza cm 40.
Cp brass towel holder, length cm 40.

CR

RICAMBI - SPARE PARTS



ACGL10VG

Portasapone in vetro satinato.
Satin glass soap holder.

CR



ACGL13LN

Dispenser in vetro satinato.
Satin glass dispenser.

CR



ACGL15VG

Bicchiere in vetro satinato.
Satin glass cup.

CR

FLAT



FT20CR



FT13CR

Dispenser per sapone liquido in ceramica con supporto in ottone.
Ceramic soap dispenser with cp brass support.

CR



FT15CR

Portabicchiere in ottone con bicchiere in ceramica.
Cp brass cup holder with ceramic glass.

CR



FT10CR

Portasapone in ceramica con supporto in ottone.
Ceramic soap dish holder with cp brass support.

CR



FT66CR

Portascopino in ceramica con supporto in ottone.
Ceramic broom rack holder with cp brass support.

CR



FT60CR

Portarotolo in ottone.
Cp brass toilet paper holder.

CR



FT61CR

Portarotolo di ricambio in ottone.
Cp brass spare toilet paper holder.

CR



FT50CR
Appendino in ottone.
Cp brass hook.

CR



FT44CR
Portasalviette ad anello in ottone.
Cp brass towel ring.

CR



FT36CR
Portasciugamano a braccia girevoli in ottone,
lunghezza cm 45.
Cp brass multiple bar towel holder with swivelling
bars, length cm 45.

CR



FT20CR
Mensola in vetro con supporti in ottone, dimensione 12x52 cm.
Glass shelf with cp brass support, dimensions 12x52 cm.

CR



FT40CR
Portasalviette in ottone, lunghezza cm 40.
Cp brass towel holder, length cm 40.

CR



FT30CR
Portasalviette in ottone, lunghezza cm 60.
Cp brass towel holder, length cm 60.

CR



FT33CR
Portasalviette doppio in ottone, lunghezza cm 60.
Cp brass double towel holder, length cm 60.

CR



FTSET8PCR

Set serie FLAT composto da 8 accessori:

- 2 portasapone
- 1 portabicchiere
- 1 portasalviette cm 60
- 1 portasalviette cm 40
- 1 portasalviette ad anello
- 1 appendino
- 1 portarotolo

Set FILAT serie composta di 8 accessori:

- 2 soap dish holders
- 1 cup holder
- 1 towel holder cm 60
- 1 towel holder cm 40
- 1 towel ring
- 1 hook
- 1 toilet paper roll holder

RICAMBI - SPARE PARTS



AC66WI
Scopino da bagno.
Toilet brush.

CR



ACCE10
Portasapone in ceramica.
Ceramic soap holder.

CR



ACCE13WI
Dispenser in ceramica.
Ceramic dispenser.

CR



ACCE15
Bicchiere in ceramica.
Ceramic cup.

CR

GUEST



GS50CR - GS13CR

GUEST OPZIONI DI FINITURA

Questa collezione di rubinetteria è disponibile con diverse opzioni di finitura, scegli il colore perfetto per il tuo progetto di arredo!
Rispondendo alle esigenze stilistiche dei progetti più ambiziosi, Remer Rubinetterie ha selezionato 7 colori, oltre al cromato, studiati per arricchire, personalizzare e differenziare gli interni di bagno e cucina.

[Per confermare la propria scelta, aggiungere il codice della finitura al termine del codice prodotto durante la fase di acquisto.]

GUEST FINISHING OPTIONS

This faucet collection is available with different finishing options, choose the perfect color to customize your interior!
Responding to the stylistic needs of the most ambitious designs, Remer Rubinetterie selected 7 colors, in addition to chrome, to enrich, customize and differentiate bathroom and kitchen interiors.

[To confirm your choice, add the finishing code at the end of the item code during the purchase phase.]

CR	
	cromo chrome
	CR

FIN 1	
	nero opaco matt black
	bianco opaco matt white
	nicel spazzolato brushed nickel
	visual inox visual steel
	NO
	BO
	NP
	XV

FIN 2	
	cromo nero spazzolato brushed black chrome
	oro spazzolato brushed gold
	oro lucido shiny gold
	CFP
	BG
	DO



GS13CR

Dispenser per sapone liquido in ceramica con supporto in ottone.
Ceramic soap dispenser with brass support.

CR FIN 1 FIN 2



GS15CR

Portabicchiere in ottone con bicchiere in ceramica.
Brass cup holder with ceramic glass.

CR FIN 1 FIN 2



GS60CR

Portarotolo in ottone.
Cp brass toilet paper holder.

CR FIN 1 FIN 2



GS44CR

Portasalviette ad anello in ottone.
Brass towel ring.

CR FIN 1 FIN 2



GS10CR

Portasapone in ceramica con supporto in ottone.
Ceramic soap dish holder with brass support.

CR FIN 1 FIN 2



GS11CR

Portasapone in ottone.
Brass soap holder.

CR FIN 1 FIN 2



GS62CR

Portarotolo di ricambio in ottone.
Brass spare toilet paper holder.

CR FIN 1 FIN 2



GS61CR

Portarotolo di ricambio in ottone.
Brass spare toilet paper holder.

CR FIN 1 FIN 2



GS66CR

Portascopino in ceramica con supporto in ottone.
Ceramic broom rack holder with brass support.

CR FIN 1 FIN 2



GS50CR

Appendino in ottone.
Brass hook.

CR FIN 1 FIN 2



GS20CR
Mensola in vetro con supporti in ottone.
Glass shelf with brass support.

CR FIN 1 FIN 2



GS33CR
Portasalviette doppio in ottone, lunghezza cm 60.
Brass double towel holder, length cm 60.

CR FIN 1 FIN 2



GS30CR
Portasalviette in ottone, lunghezza cm 60.
Brass towel holder, length cm 60.

CR FIN 1 FIN 2



GS40CR
Portasalviette in ottone, lunghezza cm 40.
Brass towel holder, length cm 40.

CR FIN 1 FIN 2



GSSET8PCR

Set serie GUEST composto da 8 accessori:

Set GUEST serie composed of 8 accessories:

- 2 portasapone
- 1 portabicchiere
- 1 portasalviette cm 60
- 1 portasalviette cm 40
- 1 portasalviette ad anello
- 1 appendino
- 1 portarotolo
- 2 soap dish holders
- 1 cup holder
- 1 towel holder cm 60
- 1 towel holder cm 40
- 1 towel ring
- 1 hook
- 1 toilet paper roll holder

CR FIN 1 FIN 2

RICAMBI - SPARE PARTS



AC66AR
Scopino da bagno.
Toilet brush.

CR



ACCE10
Portasapone in ceramica.
Ceramic soap holder.

CR



ACCE13WI
Dispenser in ceramica.
Ceramic soap dispenser.

CR



ACCE15
Bicchiere in ceramica.
Ceramic glass.

CR



GS20CR

SHUT-OFF

PLACCHE WC
TOILET PLATES

LAVABO
WASHBASIN

LOUNGE

FLAT

GUEST

SUITE

EPOCA

ACCESSORI
ACCESSORIES

IDROSCOPINI
HYDRO-BRUSH

COMPLEMENTI
COMPL. ITEMS

RICAMBI
SPARE PARTS

SUITE



SU10CR



SU13CR
Dispenser per sapone liquido in vetro satinato con supporto in ottone.
Satin glass soap dispenser with brass support.

CR



SU15CR
Portabicchiere in ottone con bicchiere in vetro satinato.
Brass cup holder with satin glass.

CR



SU10CR
Portasapone in vetro satinato con supporto in ottone.
Satin glass soap dish holder with brass support.

CR



SU44CR
Portasalviette ad anello in ottone.
Brass towel ring.

CR



SU60CR
Portarotolo in ottone.
Brass toilet paper holder.

CR



SU50CR
Appendino in ottone.
Brass hook.

CR



SU62CR
Portarotolo di ricambio in ottone.
Brass spare toilet paper holder.

CR



SU66CR
Portascopino in acciaio INOX.
Stainless steel broom rack holder.

CR



SU40CR
Portasalviette in ottone, lunghezza cm 40.
Brass towel holder, length cm 40.

CR



SU30CR
Portasalviette in ottone, lunghezza cm 60.
Brass towel holder, length cm 60.

CR



SU20CR
Mensola in vetro con supporti in ottone, dimensione 11x49,5 cm.
Glass shelf with brass support, dimensions 11x49,5 cm.

CR



SU33CR
Portasalviette doppio in ottone, lunghezza cm 60.
Brass double towel holder, length cm 60.

CR



SUSET8PCR
Set serie SQ composto da 8 accessori:

- 2 portasapone
- 1 portabicchiere
- 1 portasalviette cm 60
- 1 portasalviette cm 40
- 1 portasalviette ad anello
- 1 appendino
- 1 portarotolo

Set SQ serie composta di 8 accessories:

- 2 soap dish holders
- 1 cup holder
- 1 towel holder cm 60
- 1 towel holder cm 40
- 1 towel ring
- 1 hook
- 1 toilet paper roll holder

RICAMBI - SPARE PARTS



AC66SU
Scopino da bagno.
Toilet brush.

CR



ACGL10SU
Portasapone in vetro satinato.
Satin glass soap holder.

CR



ACGL13
Dispenser in vetro satinato.
Satin glass soap dispenser.

CR



ACGL15
Bicchiere in vetro satinato.
Satin glass.

CR

EPOCA



**IN CERAMICA BIANCA
IN WHITE CERAMIC**

EP10CR

**EP13CR**

Dispenser per sapone liquido in ceramica con supporto in ottone.
Ceramic soap dispenser with brass support.

CR

**EP15CR**

Portabicchiere in ottone con bicchiere in ceramica.
Brass cup holder with ceramic glass.

CR

**EP10CR**

Portasapone in ceramica con supporto in ottone.
Ceramic soap dish holder with brass support.

CR

**EP50CR**

Appendino in ottone.
Cp brass hook.

CR

**EP44CR**

Portasalviette ad anello in ottone.
Brass towel ring.

CR

**EP60CR**

Portarotolo in ottone.
Brass toilet paper holder.

CR

**EP62CR**

Portarotolo di ricambio in ottone.
Brass spare toilet paper holder.

CR

**EP66CR**

Portascopino in ceramica con supporto in ottone.
Ceramic broom rack holder with brass support.

CR



EP20CR

Mensola in vetro con supporti in ottone, dimensione 12x52,5 cm.
Glass shelf with brass support, dimensions 12x52,5 cm.

CR



EP40CR

Portasalviette in ottone, lunghezza cm 40.
Brass towel holder, length cm 40.

CR



EP30CR

Portasalviette in ottone, lunghezza cm 60.
Brass towel holder, length cm 60.

CR



EP33CR

Portasalviette doppio in ottone, lunghezza cm 60.
Brass double towel holder, length cm 60.

CR



EPSET8PCR

Set serie SQ composto da 8 accessori:

Set SQ serie composed of 8 accessories:

- 2 portasapone
- 1 portabicchiere
- 1 portasalviette cm 60
- 1 portasalviette cm 40
- 1 portasalviette ad anello
- 1 appendino
- 1 portarotolo

- 2 soap dish holders
- 1 cup holder
- 1 towel holder cm 60
- 1 towel holder cm 40
- 1 towel ring
- 1 hook
- 1 toilet paper roll holder

CR

RICAMBI - SPARE PARTS



AC66AR

Scopino da bagno.
Toilet brush.

CR



ACCE10

Portasapone in ceramica.
Ceramic soap holder.

CR



ACCE13WI

Dispenser in ceramica.
Ceramic soap dispenser.

CR



ACCE15

Bicchiere in ceramica.
Ceramic glass.

CR

ACCESSORI ACCESSORIES



RB281CR



RB211CR

Portasapone piccolo rettangolare in ottone.
Dimensioni: 12x9x3 cm.
*Brass small rectangular shaped soap holder.
Dimensions: 12x9x3 cm.*

CR



RB271CR

Portasapone piccolo angolare in ottone.
Dimensioni: 17x11,5x3,2 cm.
*Brass small corner soap holder.
Dimensions: 17x11,5x3,2 cm.*

CR



RB281CR

Portasapone piccolo ovale in ottone.
Dimensioni: 16x10x3,4 cm.
*Brass big oval soap holder.
Dimensions: 16x10x3,4 cm.*

CR



RB212CR

Portasapone grande rettangolare in ottone.
Dimensioni: 20,5x11,5x3 cm.
*Brass big rectangular shaped soap holder.
Dimensions: 20,5x11,5x3 cm.*

CR



RB272CR

Portasapone grande angolare in ottone.
Dimensioni: 22x14,3x6 cm.
*Brass big corner soap holder.
Dimensions: 22x14,3x6 cm.*

CR



RB282CR

Portasapone grande ovale in ottone.
Dimensioni: 24,5x11,8x3,4 cm.
*Brass small oval soap holder.
Dimensions: 24,5x11,8x3,4 cm.*

CR



RB430CR

Portasalvietta in ottone da cm 60.
Brass towel holder bar, cm 60.

CR



RB440CR

Portasalvietta in ottone da cm 40.
Brass towel holder bar cm 40.

CR



RB310CR

Appendiabito a muro minimale.
Brass minimal hook.

CR



RB312CR

Appendiabiti in linea a due ganci in ottone.
Dimensioni: 20x3 cm.
Brass clothes holder, two hooks.
Dimensions: 20x3 cm.

CR



RB313CR

Appendiabiti in linea a tre ganci in ottone.
Dimensioni: 32x3 cm.
Brass clothes holder, three hooks.
Dimensions: 32x3 cm.

CR



RB490CR

Sistema filo stendibiancheria in ottone.
Brass clothes line system.

CR



RB277CR

Portasapone doppio angolare in ottone.
Dimensioni: 30,5 x19x19,5 cm.
Brass small corner double soap holder.
Dimensions: 30,5 x19x19,5 cm.

CR



RB480CR

Maniglione vasca con portasapone in ottone.
Dimensioni: 43x21x13 cm.
Brass bathtub handle with soap holder.
Dimensions: 43x21x13 cm.

CR



RB470CR

Portasciugamano multiplo in ottone cm 60.
Brass multiple bar towel holder cm 60.

CR



RB501CR
Portarifiuti, 3 litri, in acciaio INOX.
Altezza 26 cm, Ø 17 cm.
*Toilet bin, 3 liters, in stainless steel.
Height 26 cm, Ø 17 cm.*

CR



RB502CR
Portarifiuti, 5 litri, in acciaio INOX.
Altezza 29 cm, Ø 20 cm.
*Toilet bin, 5 liters, in stainless steel.
Height 29 cm, Ø 20 cm.*

CR



RB503CR
Portarifiuti, 12 litri, in acciaio INOX.
Altezza 39 cm, Ø 25 cm.
*Toilet bin, 12 liters, in stainless steel.
Height 39 cm, Ø 25 cm.*

CR



RB600CR
Dispenser per liquidi in acciaio INOX, capacità
730 ml. Dimensioni: 18,3x10,7x6 cm.
*Dispenser for liquids in stainless steel, capacity
730 ml. Dimensions: 18,3x10,7x6 cm.*

CR



SE71
Dispenser a sensore per sapone liquido e "liquido
disinfettante". Capacità: 650 ml, batteria: 6 x 1,5V.
*Sensor dispenser for liquid soap and "liquid
disinfectant". Capacity: 650 ml, battery: 6 x 1,5 V.*

CR



CE



RB630CR
Specchio ingranditore a doppia faccia, a muro Ø
15 cm.
*Wall mounted magnifier mirror, double side, Ø
15 cm.*

CR



RB465CR
Portascopino sospeso in ottone.
Wall mounted broom rack all in Brass.

CR



RB466CR
Portascopino in acciaio INOX.
Broom rack all in stainless steel.

CR



RB635CR
Specchio ingranditore a doppia faccia, a muro Ø
21 cm.
*Wall mounted magnifier mirror, double side, Ø
21 cm.*

CR



AH75LED

Specchio ingranditore retroilluminato, con spina e interruttore. Ø 21,5 cm, estensione max 26 cm.
Magnifier backlighted mirror, power supply, and switch. Ø 21,5 cm, maximum extension 26 cm.

CR



AH77QLED

Specchio ingranditore retroilluminato, accensione al tocco, spegnimento automatico, a batteria. 18x18 cm, estensione max 34 cm.
Magnifier backlighted mirror, power touch, automatic shutdown, battery powered. 18x18 cm, maximum extension 34 cm.

CR

SHUT-OFF

PLACCHE WC
TOILET PLATES

LAVABO
WASHBASIN

LOUNGE

FLAT

GUEST

SUITE

EPOCA

ACCESSORI
ACCESSORIES

IDROSCOPINI
HYDRO-BRUSH

COMPLEMENTI
COMPL. ITEMS

RICAMBI
SPARE PARTS

IDROSCOPINI HYDRO-BRUSH



RB140S01



RB100

Idroscopino a pulsante "Lux" in ottone, con impugnatura liscia 1/2".
Brass hydro brush "Lux" with plain handgrip, 1/2".

CR



RB120

Idroscopino a pulsante quadrata, serie "SQ", in ottone, 1/2".
Brass hydro brush serie "SQ", with plain handgrip, 1/2".

CR



336L

Rubinetto d'arresto serie Minimal, con supporto doccia in ottone, per flessibile con attacco conico.
Brass minimal angle valve with shower holder, for conical nut flexibles.

CR



336S

Rubinetto d'arresto quadrato, con supporto doccia in ottone, per flessibile con attacco conico.
Brass squared angle valve with shower holder, for conical nut flexibles.

CR

Gli idroscopini e i set con idroscopini sono indicati per la pulizia dei sanitari. Il rubinetto a muro apre e chiude la fornitura di acqua, mentre la doccetta a pulsante permette di gestire l'erogazione durante l'utilizzo.

Hydro-brushes and Hydro-brush sets are suitable for the cleaning of sanitary ware. The wall tap opens and closes the water supply, while the push-button shower allows you to activate the flow during use.

SHUT-OFF

PLACCHE WC
TOILET PLATES

LAVABO
WASHBASIN

LOUNGE

FLAT

GUEST

SUITE

EPOCA

ACCESSORI
ACCESSORIES

IDROSCOPINI
HYDRO-BRUSH

COMPLEMENTI
COMPL. ITEMS

RICAMBI
SPARE PARTS



RB100S01

Set composto da: idroscopino a pulsante, flessibile con attacco conico cm 120 metallizzato in PVC, rubinetto ad angolo Minimal con vitone ceramico e supporto doccia "Lux" in ottone.
Set composed of: hydro brush handshower, PVC metallized conical flexible hose cm 120, "Minimal" angle valve with ceramic eadwork and "Lux" brass shower holder.

CR



RB100S02

Set composto da: idroscopino a pulsante, flessibile con attacco conico cm 120 in PVC con piastrina cromata, rubinetto d'arresto Minimal con vitone ceramico e supporto doccia "Lux" in ottone.
Set composed of: hydro brush handshower, PVC in chrome flat conical flexible hose cm 120, "Minimal" angle valve with ceramic eadwork and "Lux" brass shower holder.

CR



RB100TE

Set composto da: idroscopino a pulsante in ottone, flessibile conico cm 120, rubinetto temporizzato 1/2" in ottone, tempo d'apertura 6-8 secondi.
Set composed of: hydro brush in brass, flexible cm 120, temporized button flusher 1/2" all in brass, opening time 6-8 seconds.

CR



RB140S01

Set composto da: idroscopino a pulsante, flessibile con attacco conico cm 120 metallizzato in PVC, rubinetto ad angolo Minimal con vitone ceramico e supporto doccia "Lux" in ottone, comprensivo di doccetta RB100.
Set including: push-button hydrobrush, 120 cm metallized PVC flexible hose with conical connection, "Minimal" angle tap with ceramic head valve and brass "Lux" shower holder, including hand shower (RB100).

CR



RB160S01

Set composto da: idroscopino a pulsante, flessibile con attacco conico cm 120 metallizzato in PVC, rubinetto ad angolo SQ con vitone ceramico e supporto doccia "Lux" in ottone, comprensivo di doccetta RB120.
Set including: push-button hydrobrush, 120 cm metallized PVC flexible hose with conical connection, SQ corner tap with ceramic head valve and brass "Lux" shower holder, including hand shower (RB120).

CR



RB120S01

Set composto da: idroscopino a pulsante, flessibile con attacco conico cm 120 metallizzato in PVC, rubinetto ad angolo SQ con vitone ceramico e supporto doccia "Lux" in ottone.
Set composed of: hydro brush handshower, PVC metallized conical flexible hose cm 120, "SQ" angle valve with ceramic eadwork and "Lux" brass shower holder.

CR



RB120S02

Set composto da: idroscopino a pulsante, flessibile con attacco conico cm 120 in PVC con piastrina cromata, rubinetto d'arresto SQ con vitone ceramico e supporto doccia "Lux" in ottone.
Set composed of: hydro brush handshower, PVC in chrome flat conical flexible hose cm 120, "SQ" angle valve with ceramic eadwork and "Lux" brass shower holder.

CR

COMPLEMENTI - COMPL. ITEMS

COMPLEMENTI COMPLEMENTARY ITEMS



SIFONI IN FINITURA - SIPHONS IN FINISH



958L

Sifone "MINIMAL" in ottone, per lavabo, 1"1/4, canotto cm 30 e rosone pesante.
Brass "MINIMAL" P trap, for wash-basin, 1"1/4, outlet tube cm 30 and heavy flange.

CR FIN 1 FIN 2

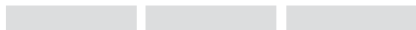

958B

Sifone "MINIMAL" in ottone, per bidet, 1"1/4, canotto cm 30 e rosone pesante.
Brass "MINIMAL" P trap, for bidet, 1"1/4, outlet tube cm 30 and heavy flange.

CR FIN 1 FIN 2

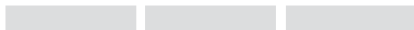

960114

Sifone SQ, in ottone, canotto cm 30, 1"1/4, con rosone pesante quadrato.
Brass SQ trap, 30 cm outlet tube, 1"1/4, with heavy squared wall flange.

CR FIN 1 FIN 2

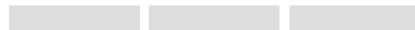

SIFONI SALVASPAZIO - SAVE SPACING SIPHONS



985

Sifone salvaspazio con piletta click-clack incorporata con troppo pieno, rotondo, cromato.
Save-spacing siphon with click-clack built-in drain with overflow, round, chrome.

CR FIN 1 FIN 2

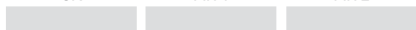

984

Sifone salvaspazio con piletta click-clack incorporata senza troppo pieno, rotondo, cromato.
Save-spacing siphon with click-clack built-in drain without overflow, round, chrome.

CR FIN 1 FIN 2

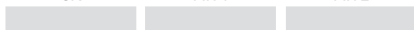

985S

Sifone salvaspazio con piletta click-clack incorporata con troppo pieno, quadrato, cromato.
Save-spacing siphon with click-clack built-in drain with overflow, squared, chrome.

CR FIN 1 FIN 2

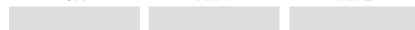

984S

Sifone salvaspazio con piletta click-clack incorporata senza troppo pieno, quadrato, cromato.
Save-spacing siphon with click-clack built-in drain without overflow, squared, chrome.

CR FIN 1 FIN 2

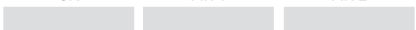

SIFONI - TRAPS



Sifone a "P" in tubo, in ottone.
"P" trap made by tube, in brass.

977114 1"1/4



Sifone "P" in tubo, in acciaio INOX.
"P" trap made by tube, in stainless steel.

977X114 1"1/4



Sifone a bottiglia in ottone, canotto cm 25.
Brass bottle trap, 25 cm outlet tube.

97010 1"

970114 1"1/4

970112 1"1/2



Sifone a bottiglia in zama senza piletta, per lavabo, 1" 1/4, canotto cm. 20.
Bottle trap in zamac without waste, for wash-basin, 1" 1/4, outlet tube cm 20.

970Z114 1"1/4

970Z112 1"1/2



Sifone a "S" in ottone, canotto cm 25.
Brass "S" trap, 25 cm outlet tube.

971114 1"1/4



Sifone a "S" in zama, canotto cm 25.
"S" trap in zamac, 25 cm outlet tube.

971Z114 1"1/4



Sifone a "U" per lavabo a colonna in ottone, canotto cm 25.
Brass "U" trap, 25 cm outlet tube.

972114 1"1/4

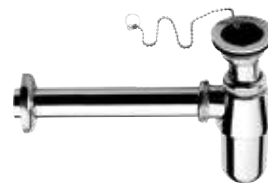

Sifone a bottiglia in zama con piletta, per lavabo.
Bottle trap in zamac with waste, for wash-basin.

973Z114 1"1/4



Sifone fuso pesante lusso in ottone, per lavabo e bidet
1", 1" 1/4 canotto cm 30.
Brass luxury "P" trap, heavy type, 1", 1" 1/4, outlet tube cm 30.

95610 1"

956114 1"1/4

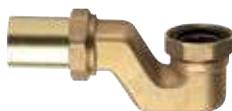

Sifone pesante in ottone fuso, con dado 1"1/2 per colonna vasca.
Heavy trap in casting brass, with nut 1"1/2 for bath waste and overflow.

98112 1"1/2



Ghiera per sifoni in ottone, 1" M x 1"1/4 F, 1"1/4 M x 1"1/2 F.
Brass reduction for trap 1" M x 1"1/4 F, 1"1/4 M x 1"1/2 F.

96810M114F 1" M x 1"1/4 F

968114M112F 1" 1/4 M x 1"1/2 F



Ghiera per sifoni in ottone, 1"1/4 M x 1" F, 1"1/2 M x 1"1/4 F.
Brass reduction for trap 1"1/4 M x 1" F, 1"1/2 M x 1"1/4 F.

969112M114F 1"1/2 M x 1"1/4 F

969114M10F 1"1/4 M x 1" F

SCARICHI AUTOMATICI CLICK-CLACK - AUTOMATIC CLICK CLACK POP-UP WASTES



904CC2114

Scarico automatico con sistema click-clack, 1"1/4, e tappo grande, senza troppo pieno, modello con bicchiere corto.
Automatic pop-up waste, click-clack system, 1"1/4, big plug, without overflow, model with shorter cup.



904CC114

Scarico automatico con sistema click-clack, 1"1/4, e tappo grande, senza troppo pieno.
Automatic pop-waste, click-clack system, 1"1/4, big plug, without overflow.

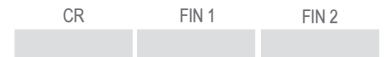

904SCC2114

Scarico automatico quadrato 1"1/4 con click-clack senza troppo pieno, modello con bicchiere corto.
Squared automatic pop-up waste 1"1/4 with click-clack system without overflow, model with shorter cup.



904SCC114

Scarico automatico quadrato 1"1/4 con click-clack senza troppo pieno.
Squared automatic pop-up waste 1"1/4 with click-clack system without overflow.

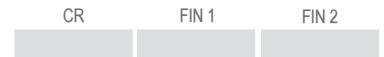

905CC2

Scarico automatico 1"1/4 con click-clack con troppo pieno, modello con bicchiere corto.
Automatic pop-up waste 1"1/4 with click-clack system with overflow, model with shorter cup.



905CC114

Scarico automatico con sistema click-clack, 1"1/4, e tappo grande, con troppo pieno.
Automatic pop-up waste, 1"1/4, click-clack system, big plug, with overflow, model with shorter cup.



905SCC2114

Scarico automatico quadrato 1"1/4 con click-clack con troppo pieno, modello con bicchiere corto.
Squared automatic pop-up waste 1"1/4 with click-clack system with overflow, model with shorter cup.

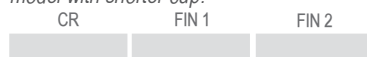

905SCC114

Scarico automatico con sistema click-clack, 1"1/4, e tappo grande, con troppo pieno.
Squared automatic pop-up waste, click-clack system, 1"1/4, with overflow.



906CC2114

Scarico automatico con sistema click-clack, 1"1/4, con troppo pieno, modello con bicchiere corto.
Automatic pop-up waste, click-clack system, 1"1/4, with overflow, model with shorter cup.



906CC114

Scarico automatico con sistema click-clack, 1"1/4, con troppo pieno.
Automatic pop-up waste, 1"1/4, click-clack system, with overflow.

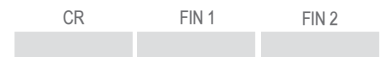

9072114

Scarico automatico 1"1/4 con tappo grande sempre aperto e sistema click-clack per la pulizia interna, modello con bicchiere corto.
Automatic pop-up waste 1"1/4 with big plug always opened, and click-clack system for internal cleaning, model with shorter cup.



907114

Scarico automatico 1"1/4 con tappo grande sempre aperto e sistema click-clack per la pulizia interna.
Automatic pop-up waste 1"1/4 with big plug always opened, and click-clack system for internal cleaning.





905CCR114
Scarico automatico universale con chiusura click-clack da 1"1/4.
Universal automatic pop-up waste 1"1/4 with click-clack system.

CR	FIN 1	FIN 2
----	-------	-------



905CCXL114
Scarico automatico con sistema click-clack, 1" 1/4, tappo grande, con troppo pieno, versione extralunga.
Automatic pop-up waste, click-clack system, 1" 1/4, big plug, with overflow, extralong version.

CR	FIN 1	FIN 2
----	-------	-------

SCARICHI AUTOMATICI - POP-UP WASTES



Scarico automatico 1", 1"1/4.
Brass pop-up waste, 1", 1"1/4.

95	1"
95	1"1/4



Scarico automatico da 1"1/4, tipo Lusso.
Brass pop-up waste 1"1/4, luxury type.

95L80	1"1/4
-------	-------



Scarico automatico in plastica da 1"1/4.
Plastic pop-up waste, 1"1/4.

95P80	1"1/4
-------	-------



Scarico automatico da 1"1/4, in zama.
Zamac 1"1/4 pop-up waste.

95Z	1"1/4
-----	-------



Scarico automatico da 1"1/4, tipo lusso lucidato, con tappo grande quadrato piatto a copertura totale della piletta.
C.p. polished pop-up waste, 1"1/4, luxury type with big squared flat plug covering the drain.

95LS80	1"1/4
--------	-------



Scarico automatico da 1"1/4, tipo lusso lucidato, con tappo grande a copertura totale della piletta.
C.P. polished pop-up waste, 1"1/4, luxury type with big plug covering the drain.

95LG80	1"1/4
--------	-------



Scarico tipo America o Americano, in ottone pulito e cromato.
C.p. waste model America or American, polished and in brass.

95AM	1"1/4
------	-------

RUBINETTI SOTTOLAVABO - ANGLE VALVES



117RA

Raccordo 3/8x10 con guarnizioni in 3 pezzi.
C.P. nut with 3 pcs washers 3/8x10.

CR



117RA1210

Raccordo 1/2x10 con guarnizioni in 3 pezzi.
C.P. nut with 3 pcs washers 1/2x10.

CR



Rubinetto sottolavabo con rosetta.
Brass angle valve with flange.

CR

1171212 1/2x1/2

1171238 1/2x3/8



1171210

Rubinetto sottolavabo con calotta e rosetta,
1/2x10.
Brass angle valve with flange, 1/2x10.

CR



1241210

Curvetta sottolavabo, 1/2x10, con rosetta in
ottone.
Brass elbow connection for wash basin, with
flange, 1/2x10.

CR



120SN1210

Rubinetto sottolavabo a vitone, con filtro e snodo,
1/2x10, con rosetta in ottone.
Brass angle valve with filter, balljoint and brass
flange, 1/2x10.

CR



121T

Rubinetto combinato 1/2" sottolavabo e 3/4"
attacco lavatrice, 1/2x3/4x10
Brass union valve 1/2", with undersink coupling
and 3/4" connection for washing machine,
1/2x3/4x10.

CR



1231210

Rubinetto sottolavabo con filtro e calotta,
1/2x10, con rosetta in ottone.
Brass angle valve with filter and flange,
1/2x10.

CR



123SN1210

Rubinetto sottolavabo con filtro e snodo,
1/2x10, con rosetta in ottone.
Brass angle valve with filter, ball joint and flange,
1/2x10.

CR

**1231212**

Rubinetto sottolavabo con filtro, 1/2x1/2, con rosetta in ottone.

Brass angle valve with filter and flange, 1/2x1/2.

CR

**127A1210**

Rubinetto sottolavabo con filtro, calotta, 1/2x10 e rosetta in ottone.

Brass angle valve with filter and flange, 1/2x10.

CR

**1291212**

Rubinetto sottolavabo 1/2x1/2 con rosetta.

Brass angle valve for wash basin 1/2x1/2 with flange.

CR

1231234

Rubinetto sottolavabo con filtro, 1/2x3/4, con rosetta in ottone.

Brass angle valve with filter and flange, 1/2x3/4.

CR

127A1212

Rubinetto sottolavabo con filtro, 1/2x1/2, con rosetta in ottone.

Brass angle valve with filter and flange, 1/2x1/2.

CR

1291238

Rubinetto sottolavabo 1/2x3/8 con rosetta.

Brass angle valve for wash basin 1/2x3/8 with flange.

CR

1231238

Rubinetto sottolavabo con filtro, 1/2x3/8, con rosetta in ottone.

Brass angle valve with filter and flange, 1/2x3/8.

CR

127A1238

Rubinetto sottolavabo con filtro, 1/2x3/8, con rosetta in ottone.

Brass angle valve with filter and flange, 1/2x3/8.

CR

**128R1210**

Rubinetto a sfera con guarnizione in PTFE, con calotta e rosetta in ottone, 1/2x10.

Brass ball valve with PTFE washer and flange, 1/2x10.

CR

**128R1212**

Rubinetto a sfera con guarnizione in PTFE e rosetta, 1/2x1/2.

Brass ball valve with PTFE washer and flange, 1/2x1/2.

CR

**128E1238**

Rubinetto sottolavabo "Esagonale", con vitone ceramico, 1/2x3/8.

Brass "Hexagonal" angle valve, with ceramic head valve, 1/2x3/8.

CR

**127ASN1210**

Rubinetto sottolavabo con filtro e snodo, 1/2x10, con rosetta in ottone.

Brass angle valve with filter, ball joint and flange, 1/2x10.

CR

128R1238

Rubinetto a sfera con guarnizione in PTFE e rosetta, 1/2x3/8.

Brass ball valve with PTFE washer and flange, 1/2x3/8.

CR

128E1210

Rubinetto sottolavabo "Esagonale", con dado e guarnizione art. 117 RA, con vitone ceramico, 1/2x10.

Brass "Hexagonal" angle valve, with nut and washers art. 117 RA, with ceramic head valve, 1/2x10.

CR

128E1212

Rubinetto sottolavabo "Esagonale", con vitone ceramico, 1/2x1/2.

Brass "Hexagonal" angle valve, with ceramic head valve, 1/2x1/2.

CR

SHUT-OFF

PLACCHE WC
TOILET PLATESLAVABO
WASHBASIN

LOUNGE

FLAT

GUEST

SUITE

EPOCA

ACCESSORI
ACCESSORIESIDROSCOPINI
HYDRO-BRUSHCOMPLEMENTI
COMPL. ITEMSRICAMBI
SPARE PARTS



128L1212

Rubinetto sottolavabo "MINIMAL", con vitone ceramico, con maniglia a leva, 1/2x1/2.
Brass "MINIMAL" angle valve, with ceramic headvalve, with lever handle, 1/2x1/2.



128S1238

Rubinetto sottolavabo quadrato, con vitone ceramico, 1/2x3/8.
Brass squared angle valve, with ceramic head valve, 1/2x3/8.



128L1238

Rubinetto sottolavabo "MINIMAL", con vitone ceramico, con maniglia a leva, 1/2x3/8.
Brass "MINIMAL" angle valve, with ceramic headvalve, with lever handle, 1/2x3/8.



128S1210

Rubinetto sottolavabo quadrato, con dado e guarnizione art. 117 RA, con vitone ceramico, 1/2x10.
Brass squared angle valve, with nut and washers art. 117 RA, with ceramic head valve, 1/2x10.



128L1210

Rubinetto sottolavabo "MINIMAL", con vitone ceramico, con maniglia a leva, dado e guarnizione art. 117 RA, 1/2x10.
Brass "MINIMAL" angle valve, with ceramic headvalve, with lever handle, nut and washers art. 117 RA, 1/2x10.

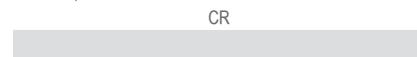

128S1212

Rubinetto sottolavabo quadrato, con vitone ceramico, 1/2x1/2.
Brass squared angle valve, with ceramic head valve, 1/2x1/2.



67

Bocca a snodo per lavello.
Swivel spout for washbasin.



67N

Bocca alta minimale.
Minimal high spout.



67Q

Bocca alta quadrata.
Squared high spout.



31N

Rubinetto d'arresto minimale 1/2".
1/2" minimal angle valve.



31N34

Rubinetto d'arresto minimale 3/4".
3/4" minimal angle valve.



31W

Rubinetto doccia incasso 1/2".
Built-in right valve 1/2".





128L121215

SHUT-OFF

PLACCHE WC
TOILET PLATES

LAVABO
WASHBASIN

LOUNGE

FLAT

GUEST

SUITE

EPOCA

ACCESSORI
ACCESSORIES

IDROSCOPINI
HYDRO-BRUSH

COMPLEMENTI
COMPL. ITEMS

RICAMBI
SPARE PARTS

COLONNE PER BORDO VASCA - VERTICAL CONNECTIONS FOR BATH MIXER



8801LI
Coppia colonne vasca in ottone, serie Liberty, 3/4M x 3/4M.
Couple brass vertical connections for bath mixer, serie Liberty, 3/4M x 3/4M.

CR



8801LIS
Coppia colonne vasca in ottone, serie Liberty, con supporto doccia, 3/4M x 3/4M.
Couple brass vertical connections for bath mixer, serie Liberty, with handshower holder 3/4M x 3/4M.

CR

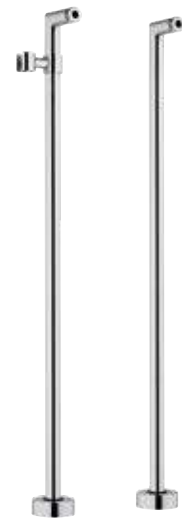

88N02
Coppia colonne vasca in ottone, serie Minimal, con supporto doccia, 3/4M x 3/4M.
Couple brass vertical connections for bath mixer, serie Minimal, with handshower holder 3/4M x 3/4M.

CR



88UK
Coppia colonnette bordo vasca in ottone, serie UK, 3/4Mx3/4M.
Couple brass vertical connections for bath mixer, serie UK, 3/4M x 3/4M.

CR



88LI
Coppia colonnette bordo vasca in ottone, serie Liberty, 3/4M x 3/4M.
Couple brass vertical connections for bath mixer, serie Liberty, 3/4M x 3/4M.

CR



88
Colonnetta per bordo vasca in ottone, 1/2M x 3/4M.
Brass vertical connection for bath mixer, 1/2M x 3/4M.

CR

DEVIATORI - DIVERTERS



Q93DEV3
Deviatore a tre vie (una entrata e tre uscite) su piastra, serie Qubika.
Three ways diverter (1 inlet and 3 outlets) on flange, Qubika serie.

CR



N93DEV3
Deviatore a tre vie (una entrata e tre uscite) su piastra, serie Minimal.
Three ways diverter (1 inlet and 3 outlets) on flange, Minimal serie.

CR



Q93DEV7
Deviatore a tre vie e sette posizioni (una entrata, tre uscite e sette posizioni con cui selezionare uscite singole o miscelate tra loro) su piastra, serie Qubika.
Three ways diverter with seven positions (1 inlet and 3 outlets and seven positions to select single or mixed outlets) on flange, Qubika serie.

CR



N93DEV7
Deviatore a tre vie e sette posizioni (una entrata, tre uscite e sette posizioni con cui selezionare uscite singole o miscelate tra loro) su piastra, serie Minimal.
Three ways diverter with seven positions (1 inlet and 3 outlets and seven positions to select single or mixed outlets) on flange, Minimal serie.

CR



COPERTURA A PAVIMENTO IN ACCIAIO INOX - STAINLESS STEEL FLOOR DRAINS

//////////////////// cm 10 x 10 //////////////////////

**913GVC10**

Copertura a pavimento in acciaio inox cm 10x10, con griglia fissa e coperchio mobile.

Stainless steel floor drain cm 10x10, with fixed grill and swivel plug.

CR

**913GV10**

Copertura a pavimento in acciaio inox cm10x10, con griglia fissa.

Stainless steel floor drain cm 10x10, with fixed grill.

CR

//////////////////// cm 15 x 15 //////////////////////

**913GVC15**

Copertura a pavimento in acciaio inox cm 15x15, con griglia fissa e coperchio mobile.

Stainless steel floor drain cm 15x15, with fixed grill and swivel plug.

CR

**913GV15**

Copertura a pavimento in acciaio inox cm 15x15, con griglia fissa.

Stainless steel floor drain cm 15x15, with fixed grill.

CR

**913CV15**

Copertura a pavimento in acciaio inox cm15x15, con coperchio avvitato fisso.

Stainless steel floor drain cm 15x15, with fixed plug.

CR

**913GFC15**

Copertura a pavimento in acciaio inox cm 15x15, con griglia e coperchio mobili.

Stainless steel floor drain cm 15x15, with swivel grill and swivel plug.

CR

//////////////////// cm 20 x 20 //////////////////////

**913GVC20**

Copertura a pavimento in acciaio inox cm 20x20, con griglia fissa e coperchio mobile.

Stainless steel floor drain cm 20x20, with fixed grill and swivel plug.

CR

**913GV20**

Copertura a pavimento in acciaio inox cm 20x20, con griglia fissa.

Stainless steel floor drain cm 20x20, with fixed grill.

CR

**913CV20**

Copertura a pavimento in acciaio inox cm 20x20, con coperchio avvitato fisso.

Stainless steel floor drain cm 20x20, with fixed plug.

CR

**913GFC20**

Copertura a pavimento in acciaio inox cm 20x20, con griglia e coperchio mobili.

Stainless steel floor drain cm 20x20, with swivel grill and swivel plug.

CR

SIFONI ANTI SCARAFAGGIO - *ANTI COCKROACH-INSECTS TRAPS*



913PSA01

Sifone anti-scarafaggio da utilizzare per coperture a pavimento cm 15x15 e 20x20.
Anti cockroach-insects to use under the floor drains with size cm 15x15 e 20x20.

CR



913PSA02

Sifone anti-scarafaggio da utilizzare per coperture a pavimento cm 10x10.
Anti cockroach-insects to use under the floor drains with size cm 10x10.

CR

CANALINE SIFONATE RETTANGOLARI - *RECTANGULAR FLOOR DRAINS*



Canalina sifonata a pavimento, in acciaio inox, con griglia di drenaggio, larghezza 12,5 cm lunghezze cm 70, 80, 90, 100, 120.
Rectangular floor drain, in stainless steel, with drain grill, large 12.5 cm, lengths cm 70, 80, 90, 100, 120.

913RG1270	70 cm
913RG1280	80 cm
913RG1290	90 cm
913RG12100	100 cm
913RG12120	120 cm



Canalina sifonata a pavimento, in acciaio inox, piastrellabile, larghezza 12,5 cm lunghezze cm 70, 80, 90, 100, 120.
Rectangular floor drain, in stainless steel, model for tiling, large 12.5 cm, lengths cm 70, 80, 90, 100, 120.

913RP1270	70 cm
913RP1280	80 cm
913RP1290	90 cm
913RP12100	100 cm
913RP12120	120 cm

PILETTE DA PAVIMENTO SIFONATE - *STAINLESS STEEL FLOOR DRAINS AND SIPHONS*



913SF10

Piletta da pavimento sifonata in acciaio inox, cm 10x10.
Stainless steel floor drain and siphon, cm 10x10.

CR



913SF15

Piletta da pavimento sifonata in acciaio inox, cm 15x15.
Stainless steel floor drain and siphon, cm 15x15.

CR



913SF20

Piletta da pavimento sifonata in acciaio inox, cm 20x20.
Stainless steel floor drain and siphon, cm 20x20.

CR

COLONNE DI SCARICO - BATH WASTES

**96P**

Colonna di scarico automatica in plastica con filo esterno, senza dado e codulo.
Plastic combined bath waste with automatic pop-up with external wire.

CR

**96PCC**

Colonna di scarico in plastica, con piletta "click-clack".
Plastic combined bath waste and overflow, "click-clack" waste system.

CR

**96LICC**

Colonna di scarico con sifone per vasca con tubo in rame cromato e piletta click-clack, tutta cromata.
Bath brass waste with siphon, trap, chromated copper tube and click clack waste, all in chrome plated.

CR

**96LIT**

Colonna di scarico con sifone per vasca con tubo in rame cromato, tutta cromata.
Bath brass waste with siphon, trap and chromated copper tube, all in chrome plated.

CR

**96**

Colonna di scarico automatica con filo esterno e tubo in rame senza dado e codulo.
Brass automatic bath waste and overflow with external wire and copper tube.

CR

**96CC**

Colonna di scarico con tubo in rame, con piletta "click-clack".
Brass waste and overflow with copper tube and "click-clack" waste.

CR

**96VA**

Colonna di scarico automatico con filo esterno e tubo in rame cm 70, per vasca ad angolo.
Brass automatic bath waste, overflow and copper tube, cm 70, for bath tube edge.

CR

SHUT-OFF

PLACCHE WC
TOILET PLATESLAVABO
WASHBASIN

LOUNGE

FLAT

GUEST

SUITE

EPOCA

ACCESSORI
ACCESSORIESIDROSCOPINI
HYDRO-BRUSHCOMPLEMENTI
COMPL. ITEMSRICAMBI
SPARE PARTS

RICAMBI - SPARE PARTS

RICAMBI SPARE PARTS





SHUT-OFF

PLACCHE WC
TOILET PLATES

LAVABO
WASHBASIN

LOUNGE

FLAT

GUEST

SUITE

EPOCA

ACCESSORI
ACCESSORIES

IDROSCOPINI
HYDRO-BRUSH

COMPLEMENTI
COMPL. ITEMS

RICAMBI
SPARE PARTS

CARTUCCE IN BLISTER CARTRIDGES IN BLISTER



S50Y

Cartuccia Ø mm 40 a dischi in ceramica per vasca, lavabo, bidet (tipo con distributori).
Ceramic cartridge Ø 40 mm for bath, wash basin, bidet (type with distributor).

CR



S52Y

Cartuccia Ø mm 40 a dischi in ceramica per lavello, doccia (tipo piatto).
Ceramic cartridge Ø 40 mm for sink and shower (flat bottom type).

CR



R50Y

Cartuccia Ø mm 35 a dischi in ceramica per vasca, lavabo, bidet (tipo con distributori).
Ceramic cartridge Ø 35 mm for bath, wash basin, bidet (type with distributor).

CR



R52Y

Cartuccia Ø mm 35 a dischi in ceramica per lavello, doccia (tipo piatto).
Ceramic cartridge Ø 35 mm for sink and shower (flat bottom type).

CR



W50Y

Cartuccia Ø mm 35 a dischi ceramica per lavello, doccia, vasca, bidet (tipo piatto).
Ceramic cartridge Ø 35 mm for sink, shower, bath, bidet (flat bottom type).

CR

CARTUCCE - CARTRIDGES



CLICK SYSTEM



S50AF

Cartuccia ad apertura forzata Ø mm 40 a dischi ceramici per vasca, lavabo, bidet (tipo con distributori) permette un notevole risparmio idrico.
Forced opening ceramic cartridge Ø 40 mm for bath, wash basin, bidet (type with distributors) permit a remarkable saving of water.

CR



CLICK SYSTEM



S52AF

Cartuccia ad apertura forzata Ø mm 40 a dischi ceramici per lavello, doccia (tipo piatto) permette un notevole risparmio idrico.
Forced opening ceramic cartridge Ø 40 mm for sink, shower (flat bottom type) permit a remarkable saving of water.

CR



CLICK SYSTEM



R50AF

Cartuccia ad apertura forzata Ø mm 35 a dischi ceramici per lavello, doccia (tipo con distributori) permette un notevole risparmio idrico.
Forced opening ceramic cartridge Ø 35 mm for sink, shower (type with distributors) permit a remarkable saving of water.

CR



CLICK SYSTEM



R52AF

Cartuccia ad apertura forzata Ø 35 mm a dischi ceramici per lavello, doccia (tipo piatto) permette un notevole risparmio idrico.
Forced opening ceramic cartridge Ø 35 mm for sink, shower (flat bottom type) permit a remarkable saving of water.

CR



P50

Cartuccia progressiva Ø 35 mm, con distributori, con chiusura del flusso e uscita dell'acqua verso il basso.
Ceramic cartridge Ø 35 mm, with distributors, with flow shut-off and water outlet towards the low.

CR



P52

Cartuccia progressiva Ø 35 mm, senza distributori, con chiusura del flusso e uscita dell'acqua verso il basso.
Ceramic cartridge Ø 35 mm, without distributors, with flow shut-off and water outlet towards the low.

CR



R52AP
Cartuccia lavello-doccia d.35 alta port

CR



X50125
Cartuccia Ø25 mm (tipo aperto).
Ceramic cartridge Ø25 mm (opened type).

CR



X52125
Cartuccia Ø25 mm (tipo chiuso).
Ceramic cartridge Ø25 mm (closed type).

CR



X52
Cartuccia Ø25 mm (tipo aperto).
Ceramic cartridge Ø25 mm (opened type).

CR



X52C
Cartuccia Ø25 mm (tipo chiuso).
Ceramic cartridge Ø25 mm (closed type).

CR



V50A
Cartuccia a dischi ceramici Ø 25, con uscita dell'acqua direttamente dalla parte alta dell'involucro a cilindro senza quindi essere riconvogliato verso il fondo della cartuccia.
Ceramic discs cartridge Ø 25, with water outlet directly from the top part of the cylindrical shell without being joined towards the bottom of the cartridge.

CR



V50C
Cartuccia a dischi ceramici Ø 25 mm, tipo piatto.
Ceramic cartridge Ø 25 mm, flat bottom type

CR



J50
Cartuccia a dischi ceramici Ø mm 35, movimento a "joystick", tipo piatto.
Ceramic cartridge Ø 35 mm, "joystick" movement, flat bottom type

CR



E50C
Cartuccia termostatica coassiale serie MINIMAL THERMO e QUBIKA THERMO.
Thermostatic coaxial cartridge serie MINIMAL THERMO and QUBIKA THERMO.

CR



E50P
Cartuccia termostatica con rotazione manopola a 330° angolari, blocco di sicurezza a 38°C, campo di lavoro da 5°C a 80°C, campo di pressione da 1 a 10 bar, filtro inox e sistema di sicurezza con blocco dell'erogazione in caso di mancanza di una delle due acque, realizzato con materiali termoplastici ad elevata robustezza.
Thermostatic cartridge with 330° angular handle rotation, 38° safety lock, working field from 5°C to 80°C, pressure field from 1 to 10 bar, stainless steel filter and safety system with the outlet lock in case there is one water lock, high performance thermoplastic materials.

CR

SHUT-OFF

PLACCHE WC
TOILET PLATES

LAVABO
WASHBASIN

LOUNGE

FLAT

GUEST

SUITE

EPOCA

ACCESSORI
ACCESSORIES

IDROSCOPINI
HYDRO-BRUSH

COMPLEMENTI
COMPL. ITEMS

RICAMBI
SPARE PARTS

PROLUNGHE WALLBOX - WALLBOX EXTENSIONS



WB15PROL

Prolunga scatola incasso
Adatto per :
Built-in box extension
Suitable for :
WBOX15

CR

WB92PROL

Prolunga scatola incasso
Adatto per :
Built-in box extension
Suitable for :
WBOX92 - WBOX92Z

CR

WB93PROL

Prolunga scatola incasso
Adatto per :
Built-in box extension
Suitable for :
WBOX93 - WBOX93Z

CR



WB97D2PROL

Prolunga scatola incasso
Adatto per :
Built-in box extension
Suitable for :
WBOX97D2

CR

WB97D3PROL

Prolunga scatola incasso
Adatto per :
Built-in box extension
Suitable for :
WBOX97D3

CR

WB98D2PROL

Prolunga scatola incasso
Adatto per :
Built-in box extension
Suitable for :
WBOX98D2

CR



WB98D3PROL

Prolunga scatola incasso
Adatto per :
Built-in box extension
Suitable for :
WBOX98D3

CR

WB98D4PROL

Prolunga scatola incasso
Adatto per :
Built-in box extension
Suitable for :
WBOX98D4

CR

WB98D5PROL

Prolunga scatola incasso
Adatto per :
Built-in box extension
Suitable for :
WBOX98D5

CR



PROLUNGHE - EXTENSIONS



K09PROL
Prolunga per corpo monocomando doccia incasso con deviatore per cartuccia Ø 40 mm.
Extension for built-in shower mixer body with diverter for cartridge Ø 40 mm.

CR



N09PROL
Prolunga per corpo monocomando doccia incasso con deviatore per cartuccia Ø 35 mm.
Extension for built-in shower mixer body with diverter for cartridge Ø 35 mm.

CR



N09HPROL
Prolunga per corpo monocomando doccia incasso con deviatore a vitone per cartuccia Ø 35 mm.
Extension for built-in shower mixer body with diverter for cartridge Ø 35 mm.

CR



S52PROL
Prolunga per corpo monocomando doccia incasso per cartuccia Ø 40 mm.
Extension for built-in shower mixer body for cartridge Ø 40 mm.

CR



R52PROL
Prolunga per corpo monocomando doccia incasso per cartuccia Ø 35 mm.
Extension for built-in shower mixer body for cartridge Ø 35 mm.

CR



QD15PROL
Prolunga per lavabo incasso. Anche in versione "Box Incasso". Adatto per:
Extension for built-in basin mixer. Also available in "Built-in Box" version. Suitable for:
QD15

CR



X15PROL
Prolunga per lavabo incasso. Anche in versione "Box Incasso". Adatto per:
Extension for built-in basin mixer. Also available in "Built-in Box" version. Suitable for:
X15

CR



MC15PROL
Prolunga per lavabo incasso. Anche in versione "Box Incasso". Adatto per:
Extension for built-in basin mixer. Also available in "Built-in Box" version. Suitable for:
MC15 - AL15 - CH15 - CEC15

CR



Q15PROL
Prolunga per lavabo incasso. Anche in versione "Box Incasso". Adatto per:
Extension for built-in basin mixer. Also available in "Built-in Box" version. Suitable for:
W15 - EY15 - I15 - D15 - L15 - Q15

CR



V15PROL
Prolunga per lavabo incasso. Anche in versione "Box Incasso". Adatto per:
Extension for built-in basin mixer. Also available in "Built-in Box" version. Suitable for:
V15 - AU15

CR

DEVIATORI AUTOMATICI - AUTOMATIC DIVERTERS



DEVK9
Deviatore, per incasso doccia, in ottone automatico con molla e fermo per basse pressioni.
Automatic brass diverter with spring and lock for low pressure.

CR



DEV00
Deviatore in ottone automatico con molla e fermo per basse pressioni.
Automatic brass diverter with spring and lock for low pressure.

CR



DEV08
Deviatore in ottone automatico con molla e fermo, con prolunga 8 mm.
Automatic brass diverter with spring and lock, mm 8 extended in 1/2 side.

CR

SHUT-OFF

PLACCHE WC
TOILET PLATES

LAVABO
WASHBASIN

LOUNGE

FLAT

GUEST

SUITE

EPOCA

ACCESSORI
ACCESSORIES

IDROSCOPINI
HYDRO-BRUSH

COMPLEMENTI
COMPL. ITEMS

RICAMBI
SPARE PARTS

VITONI - HEADVALVES



76N40DW
Vitone per acqua depurata
(ricambio)

CR



76N09H
Vitone per 09H (ricambio)

CR



7719
Vitone con filetto 19/19, per rubinetti
incasso.
*19/19 Head valve thread, for built-in
stop cocks.*

CR



78
Vite fissa maniglia.
Screw for fixing handle.

CR



74E
Come 74, tipo leggero.
As 74, light type.

CR



74F
Vitone da 1/2 con filetto per
coprivitone M24x1.
*Head valve 1/2 with thread M24x1
for head valve cover.*

CR



7718
Vitone filetto 18/19 per art. 221, 223,
224, 250, 252 e altri.
*18/19 Head valve thread for art.
221, 223, 224, 250, 252 and others.*

CR



7738
Vitone con filetto 3/8, per rubinetti.
3/8 Head valve thread, for taps.

CR



76DX180
Vitone 180° a dischi ceramici,
broccia Ø mm 8, 20 denti, destro.
*Head valve 180° ceramic discs,
broach Ø 8 mm, 20 teeth, right.*

CR



76DX24
Vitone 90° a dischi ceramici, broccia
Ø 8 mm, 24 denti, destro.
*Head valve 90° ceramic discs,
broach Ø 8 mm, 24 teeth, right.*

CR



76DX
Vitone 90° a dischi ceramici,
broccia Ø 8 mm, 20 denti, destro.
*Head valve 90° ceramic discs,
broach Ø 8 mm, 20 teeth, right.*

CR



76SX180
Vitone 180° a dischi ceramici,
broccia Ø mm 8, 20 denti, sinistro.
*Head valve 180° ceramic discs,
broach Ø 8 mm, 20 teeth, left.*

CR



76SX24
Vitone 90° a dischi ceramici, broccia
Ø 8 mm, 24 denti, sinistro.
*Head valve 90° ceramic discs,
broach Ø 8 mm, 24 teeth, left.*

CR



76SX
Vitone 90° a dischi ceramici, broccia
Ø 8 mm, 20 denti, sinistro.
*Head valve 90° ceramic discs,
broach Ø 8 mm, 20 teeth, left.*

CR



74
Vitone da 1/2 per gruppo vasca,
lavello, batteria lavabo, rubinetto
bidet e incasso per art. 53, 55.
*Head valve 1/2° for bath, sink, wash
basin, bidet and built-in stop cock
for art. 53, 55.*

CR

AERATORI - AERATORS

**81A**

Aeratore anticalcare ad alta tecnologia F22, brevettato e di lunghissima durata, scocca in ottone ed interno in materiale plastico innovativo a forte resistenza.

High technology antilimestone aerator F22, patented and long-lasting, shell in brass, internal in innovative plastic material very resistant.

CR

**83A**

Aeratore anticalcare ad alta tecnologia M24, brevettato e di lunghissima durata, scocca in ottone ed interno in materiale plastico innovativo a forte resistenza.

High technology antilimestone aerator M24, patented and long-lasting, shell in brass, internal in innovative plastic material very resistant.

CR

**83C**

Chiave brevettata per la pulizia settimanale degli aeratori ad alta tecnologia art 81 A e art 83 A.

Patented key for the weekly cleaning of the high technology aerators art 81 A and 83 A.

CR

**81**

Aeratore classico con retine in inox, per gruppo lavello F22.

Classic aerator with inox nets, for sink spout F22.

CR

**83**

Aeratore classico con retine in inox, per lavabo, lavello e bidet M24.

Classic aerator with inox nets, for basin, bidet and sink, M24.

CR

**84A**

Aeratore per gruppo vasca, M28.

Aerator for bath mixer, M28.

CR

**83F16**

Aeratore F16.

F16 aerator.

CR

**81SN**

Snodo attacco F22 con ghiera M22.

Joint F22 and nut M22.

CR

**83SN**

Snodo attacco M22 con ghiera M24.

Joint M22 and nut M24.

CR

**83N41**

Aeratore M18.

M18 aerator.

CR

**85**

Aeratore con snodo per monoforo bidet, M24.

Balljoint aerator for one-hole bidet, M24.

CR

**83NESI**

Aeratore Neoperl autopulente M24X1 con erogatore in silicone morbido anticalcare per una pulizia manuale semplificata.

Neoperl aerator selfcleaning M24X1 with silicon antilimestone bottom, for soft simplified handcleaning.

CR

**83NE**

Aeratore Neoperl effetto a scomparsa, con filetto M24X1 che puo' essere sostituito senza difficoltà a tutte le rubinetterie con filettatura per aeratore M24X1. Molto indicato per modelli di design quali Qubika, Minimal, SQ.

Neoperl aerator with built-in effect, M24X1 thread, can be easily substituted to all the standard mixers with M24X1 aerators. Very indicated for design models like Qubika, Minimal, SQ.

CR

**83NEBA**

Aeratore Neoperl M24X1 con getto direzionabile tramite terminale basculante, permette con il semplice tocco della parte inferiore dell'aeratore di dirigere il flusso della direzione desiderata.

Neoperl aerator M24X1 with swivel aerator bottom that, with the simple touch, permits to move the flow to the preferred direction.

CR

SHUT-OFF

PLACCHE WC
TOILET PLATESLAVABO
WASHBASIN

LOUNGE

FLAT

GUEST

SUITE

EPOCA

ACCESSORI
ACCESSORIESIDROSCOPINI
HYDRO-BRUSHCOMPLEMENTI
COMPL. ITEMSRICAMBI
SPARE PARTS



83EU

Aeratore Neoperl M24 coin slot. Installazione e rimozione dell'aeratore utilizzando una moneta inserita nell'apposita fessura.

Neoperl aerator M24 coin slot. Installation and removal of the aerator by using a coin placed in the slot.

CR



83F165

Aeratore a scomparsa M16,5x1 (da utilizzare con chiave 83C165). Di serie nei miscelatori per lavabo della collezione X-Style.

Hidden aerator M16,5x1 (to be used with 83C165 key). Standard in the basin mixers of X-Style collection.

CR



83C165

Chiave per la sostituzione e la pulizia degli aeratori a scomparsa M16,5 (vedi modello 83F165).

Key for replacement and cleaning of M16,5 hidden aerators (see item 83F165).

CR



83FLBA

Aeratore ultrapiatto M24 basculante per regolare l'inclinazione del flusso (da utilizzare con chiave 83FLC). Di serie nei miscelatori per lavabo delle collezioni Vanity e Absolute.

Ultra-flat aerator M24 with tilting plate for adjustable stream angle (to be used with 83FLC key). Standard in basin mixers of Vanity and Absolute collections.

CR



83FLC

Chiave per la sostituzione e la pulizia degli aeratori ultrapiatti M24 (vedi modelli 83FLBA, 83EU, 83NE).

Key for replacement and cleaning of M24 ultra-flat aerators (see items 83FLBA, 83EU, 83NE).

CR



83NEX02C

Chiave per la sostituzione e la pulizia degli aeratori 83NEX02.

Key for replacement and cleaning of 83NEX02 aerators.

CR



83C185

Chiave per la sostituzione e la pulizia degli aeratori 83QK72.

Key for replacement and cleaning of 83QK72 aerators.

CR



83C16

Chiave per la sostituzione e la pulizia degli aeratori diametro 16 - 18 (83F16).

Key for replacement and cleaning of aerators diameter 16 - 18 (83F16).

CR



83NEX02

Aeratore a scomparsa M24x1 (da utilizzare con chiave 83NEX02C).

Hidden aerator M24x1 (to be used with 83NEX02C key).

CR



83QK72

Aeratore a scomparsa M18,5 x 1

Hidden aerator M18,5 x 1

CR



AERATORI: LINEA RISPARMIO IDRICO-ENERGICO E ANTIVANDALICO
AERATORS: WATER ENERGY SAVING LINE AND ANTI-VANDALISM



83AVC

Kit antivandalico e anticalcare composto da aeratore speciale per miscelatori lavabo e bidet M24 e chiave di montaggio, manutenzione e pulizia settimanale, ad alta tecnologia, brevettata. *Anti-vandalism and antilimestone kit, composed of special aerator for wash basin and bidet mixers M24 and assembly, caring and weekly cleaning key, high technology and patented.*

CR



Set risparmio idrico totale composto da raccordo doccia 1/2" in ottone a portata limitata, aeratore lavabo e bidet M24 a portata limitata e chiave di montaggio manutenzione e pulizia settimanale, ad alta tecnologia, brevettata. Il kit è disponibile in varianti da 6 litri al minuto (cod 83 SET L6) o 8 litri al minuto (cod 83 SET L8).

Total water saving set, composed of 1/2" shower connection with reduced flow in brass, wash basin and bidet aerator with reduced flow and assembly, caring and weekly cleaning key, high technology, patented. This set is available with outlet flow of 6 liters by minute (cod 83 SET L6) or 8 liters by minute (cod 83 SET L8).

83SETL6 6 lt / min

83SETL8 8 lt / min



Kit come 83 AVC, più risparmio idrico, che include anche limitatore di portata da 6 litri al minuto, art 83AVC L6, o limitatore di portata da 8 litri al minuto, art 83 AVC L8.

Kit same as 83 AVC, plus water saving, that also includes one reduction of water consumption at 6 liters by minute, art 83 AVC L6, or one reduction of water consumption at 8 liters by minute, art 83 AVC L8.

83AVCL6 6 lt / min

83AVCL8 8 lt / min



Aeratore lavabo e bidet M24, per risparmio idrico con limitatore di portata da 6 litri al minuto (art. 83 L6) o da 8 litri al minuto (art. 83 L8).

Aerator for wash basin and bidet mixers, M24, water saving, with reduction of consumption and excellent flow at 6 litres by minute (art. 83 L6) or 8 liters by minute (art. 83 L8).

83L6 6 lt / min

83L8 8 lt / min



Raccordo doccia 1/2" a risparmio idrico con limitatore di portata da 6 litri al minuto (art 309 L6) o 8 litri al minuto (art 309 L8).

Brass connection, water saving program with flow reduction at 6 liters by minute (art 309 L6) or 8 liters by minute (art 309 L8).

309RL6 6 lt / min

309RL8 8 lt / min



662FI12

Guarnizione da 1/2" con filtro retinato anti-impurità.

1/2" washer with net filter, anti-impurity.

CR

KIT PULIZIA AERATORE - CLEANING KIT WITH AERATOR



83SET01

Set completo di 3 aeratori anticalcare M24 ad alta tecnologia + 1 chiave per la pulizia settimanale, brevettati e di lunghissima durata, il tutto in ottone e materiale plastico innovativo a forte resistenza, confezionato in un tubo contenitore rigido e trasparente adatto per essere appeso. La chiave è stata studiata per pulire il calcare dall'aeratore in un solo semplice movimento.

Set complete of 3 antilimestone M24 aerators of high technology + 1 weekly cleaning key, patented and extremely long lasting, all in brass and innovative plastic material very resistant, packed in a holding hard and transparent tube, suitable to be hung. The key has been studied to clean the aerator in one simple, easy movement.

CR



83SET02

Set completo di 2 aeratori anticalcare M24 ad alta tecnologia ed e 1 aeratore anticalcare F22 + 1 chiave per la pulizia settimanale, brevettati e di lunghissima durata, il tutto in ottone e materiale plastico innovativo a forte resistenza, confezionato in un tubo contenitore rigido e trasparente adatto per essere appeso. La chiave è stata studiata per pulire il calcare dall'aeratore in un solo semplice movimento.

Set complete of 2 antilimestone M24 aerators of high technology and 1 antilimestone F22 aerator + 1 weekly cleaning key, patented and extremely long lasting, all in brass and innovative plastic material very resistant, packed in a holding hard and transparent tube, suitable to be hung. The key has been studied to clean the aerator in one simple, easy movement.

CR

RICAMBI - SPARE PARTS



81AC

Set completo di 1 aeratore F22 anticalcare ad alta tecnologia + 1 chiave di pulizia settimanale, brevettati e di lunghissima durata, il tutto in ottone e materiale plastico innovativo a forte resistenza. L'aeratore e la chiave sono stati studiati per pulire il calcare dall'aeratore in un solo semplice movimento.

Set complete of 1 antilimestone F22 aerator of high technology + 1 weekly cleaning key, patented and extremely long lasting, all in brass and innovative plastic material very resistant. The aerator and the key has been studied to clean the aerator in one simple, easy movement.

CR



83AC

Set completo di 1 aeratore M24 anticalcare ad alta tecnologia + 1 chiave di pulizia settimanale, brevettati e di lunghissima durata, il tutto in ottone e materiale plastico innovativo a forte resistenza. L'aeratore e la chiave sono stati studiati per pulire il calcare dall'aeratore in un solo semplice movimento.

Set complete of 1 antilimestone M24 aerator of high technology + 1 weekly cleaning key, patented and extremely long lasting, all in brass and innovative plastic material very resistant. The aerator and the key has been studied to clean the aerator in one simple, easy movement.

CR

RIDUZIONI - REDUCTIONS



81RD12

Riduzione 1/2MxM22. Consente di collegare qualsiasi attacco da 1/2F", esempio tutti i flessibili doccia, con un aeratore standard lavabo/lavello F22, vedi ns articolo 81A (al posto di una doccetta o di uno shut off).

Reduction 1/2MxM22. Allows to connect any 1/2F" connection, for example all the shower flexibles, with a standard aerator basin/sink F22, see our art. 81A (instead of the classic handshower or shut-off).

CR



83RD12

Riduzione 1/2MxF24. Consente di collegare qualsiasi attacco da 1/2F", esempio tutti i flessibili doccia, con un aeratore standard lavabo M24, vedi ns articolo 83A (al posto di una doccetta o di uno shut off).

Reduction 1/2MxF24. Allows to connect any 1/2F" connection, for example all the shower flexibles, with a standard aerator basin/sink M24, see our art. 83A (instead of the classic handshower or shut-off).

CR



83RD12F22

Riduzione 1/2FxM22. Consente di collegare al lavabo/lavello F22 un qualsiasi componente con attacco 1/2M.

1/2FxM22 reduction. Connecting any component with 1/2M connection to the washbasin/sink F22.

CR



81RD12M22F

Riduzione 1/2MxF22. Consente di collegare al lavabo/lavello F22 un qualsiasi componente con attacco 1/2F.

1/2MxF22 reduction. Connecting any component with 1/2F connection to the washbasin/sink F22.

CR



83RD12M24M

Riduzione 1/2MxM24. Consente di collegare al lavabo/lavello M24 un qualsiasi componente con attacco 1/2F.

1/2MxM24 reduction. Connecting any component with 1/2F connection to the washbasin/sink M24.

CR



83RD12F24M

Riduzione 1/2FxM24. Consente di collegare al lavabo/lavello M24 un qualsiasi componente con attacco 1/2M.

1/2FxM24 reduction. Connecting any component with 1/2M connection to the washbasin/sink M24.

CR



82

Aeroflux a due getti, con doccetta a snodo, filetto F22 con riduzione M24.

Double spray aerator, with balljoint shower, thread F22 with reduction M24.

CR



82LGH

Aeroflux a due getti, con ghiera e filetto F22, lunghezza 15 cm.

Double spray aerator, with nut and thread F22, length 15 cm.

CR



82UN

Aeroflux a due getti, con doccetta a snodo, con attacco universale.

Double spray aerator, with balljoint shower, with standard connection.

CR

ECCENTRICI E DISTANZIATORI - *ECCENTRICS & CONNECTIONS*



89
Eccentrico per gruppi, 1/2x3/4, con rosone in ottone.
Eccentric unions for mixers, 1/2x3/4, with Brass flange.

CR



89L
Eccentrico per gruppi, 1/2x3/4, tipo Lusso, con rosone in ottone.
Eccentric unions for mixers, 1/2x3/4, with Brass flange, luxury type.

CR



Eccentrico per gruppi, 1/2x3/4, con rosone minimale in ottone.
Eccentric unions for mixers, 1/2x3/4, with minimal Brass flange.

89N Ø 6 cm

89NR70 Ø 7 cm



Distanziatore per gruppi, 1/2x3/4, lunghezza cm.4, 6, 8.
Brass S-connection for mixers, 1/2x3/4, length 4, 6, 8 cm.

9012344 4 cm

9012346 6 cm

9012348 8 cm

BOCCHIE - *SPOUTS*



22,5 cm



86
Canna lavello inferiore a "S", cm 22,5, tipo universale, con aeratore.
Lower "S" sink spout, cm 22,5, universal type, with aerator.

CR



20 cm



86N
Canna lavello inferiore a "S", cm 20, con aeratore.
Lower "S" sink spout, cm 20, with aerator.

CR

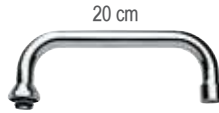

20 cm



86U
Canna lavello superiore a "U", cm 20, con aeratore.
Upper "U" sink spout, cm 20, with aerator.

CR



92U
Canna a "U" Ø 22, con aeratore.
"U" spout Ø 22, with aerator.

CR



87N
Canna a "J" per monoforo lavello, con aeratore.
"J" spout for one-hole sink mixer, with aerator.

CR



87
Canna a "J" per monoforo lavello, tipo universale, con aeratore.
"J" spout for one-hole sink mixer, universal type, with aerator.

CR



92C
Canna a biscotto a "C" con calotta da 3/4, con aeratore.
"C" spout with nut 3/4, with aerator.

CR



92CC
Canna a biscotto a "C" con calotta da 3/4, con aeratore, tipo corto.
"C" spout with nut 3/4, with aerator, short type.

CR



30 cm



93
Canna fusa lunga cm 30 con deviatore, con calotta da 3/4 ed aeratore.
Casted cm 30 long spout with diverter, with 3/4 nut, with aerator.

CR



92B
Canna a "C" con aeratore.
"C" spout with aerator.

CR



92BC
Canna a "C" corta con aeratore.
Short "C" spout with aerator.

CR

RICAMBI - SPARE PARTS



Canna a biscotto diritta, calotta da 3/4, con aeratore.
Straight spout with 3/4 nut, with aerator.

9216	16 cm
9220	20 cm
9230	30 cm
9240	40cm
9250	50 cm



Canna a biscotto a "S", calotta da 3/4, con aeratore.
"S" spout with 3/4 nut, with aerator.

92S16	16 cm
92S20	20 cm
92S30	30 cm

SCARICHI - WASTES



Tappo scarico automatico in ottone per pileta 1" e per pileta 1"1/4.
Brass plug for pop-up waste for drain 1" and for drain 1"1/4.

95TA10	1"
95TA114	1"1/4



95TAG
Tappo grande in acciaio inox per scarico automatico con pileta da 1"1/4.
Large cup in stainless steel for pop-waste, with drain 1"1/4.

CR



95TAS
Tappo grande quadrato in ottone per scarico automatico con pileta da 1"1/4.
Squared big plug in brass for pop-up waste with drain 1"1/4.

CR



96TA
Tappo in ottone per colonna vasca automatica.
Chrome plated brass plug for automatic bath waste and overflow.

CR



BAK10
Basetta in ottone per rubinetteria tipo serie Kiss, Ten, Giga.
Base in brass for mixers like serie Kiss, Ten, Giga.

CR



80SN
Morsetto con vite per scarico automatico.
Joint with screw for pop-up waste.

CR



94
Asta per scarico automatico, lunghezza cm 30, in ottone.
Rod for pop-up waste, length 30 cm, in brass.

CR



95AC
Asta e centralina bidet per scarico automatico, in ottone.
Rod and flange for bidet for pop-up automatic waste, in brass.

CR



ASX10
Asta per scarico automatico in ottone.
Rod for pop-up waste in brass.

CR



AST10

Asta con pomolo e snodino per serie Ten, in ottone.
Rod with knob and small joint for Ten series, in brass.

CR



ASK10

Asta con pomolo e snodino per serie Kiss, in ottone.
Rod with knob and small joint for Kiss series, in brass.

CR



FISW10

Confezione di fissaggio per art. W10, MC10, EY10, AU10, V10, SL10.
Fixing set for art. W10, MC10, EY10, AU10, V10, SL10.

CR



FISL72

Confezione di fissaggio per art. W72, EY72, AU72
Fixing set for art. W72, EY72, AU72.

CR



FISQK73

Confezione di fissaggio per art. L40DW
Fixing set for art. L40DW.

CR



FISQK73L

Confezione di fissaggio per art. L84, L84DJ.
Fixing set for art. L84, L84DJ.

CR



FISK10

Confezione di fissaggio per art. K10, K20, K40.
Fixing set for art. K10, K20, K40.

CR



FISR10

Confezione di fissaggio per art. R10, R20, R40.
Fixing set for art. R10, R20, R40.

CR



FISSE18

Confezione di fissaggio per art. L72U, L72C, L79DW, QD10.
Fixing set for art. L72U, L72C, L79DW, QD10.

CR



FISA10

Confezione di fissaggio per: Atmos, Flash, Qubika Cascata.
Fixing set for: Atmos, Flash, Qubika Waterfall.

CR



FISB10

Confezione di fissaggio per art. S42 U, S10 G, B10, B20, Q42U, Q10 G.
Fixing set for art. S42 U, S10 G, B10, B20, Q42U, Q10 G.

CR

DOCCHETTE CUCINA - KITCHEN HANDSHOWER



Doccetta per parrucchiere, nera.
Handshower for hairdresser, black.

- K66DONE** SENZA SCATOLA
WITHOUT BOX
- K66DONEX** CON SCATOLA
WITH BOX



Doccetta cromata per monoforo lavello.
Pull-out handshower for single-hole sink mixer.

- 331K47** SENZA SCATOLA
WITHOUT BOX
- 331K47X** CON SCATOLA
WITH BOX



Doccetta cromata per monoforo lavello, bianca.
Pull-out handshower for single-hole sink mixer, white.

- 331K47BI** SENZA SCATOLA
WITHOUT BOX
- 331K47BIX** CON SCATOLA
WITH BOX



Doccetta per monoforo lavello.
Handshower for single-hole sink mixer.

- 331** SENZA SCATOLA
WITHOUT BOX
- 331X** CON SCATOLA
WITH BOX



Doccetta cromata per monoforo lavello, a due funzioni.
Pull-out handshower for single-hole sink mixer, two functions.

- 331N82** SENZA SCATOLA
WITHOUT BOX
- 331N82X** CON SCATOLA
WITH BOX



Doccetta cromata per monoforo lavello, a due funzioni.
Pull-out handshower for single-hole sink mixer, two functions.

- 331N82C** SENZA SCATOLA
WITHOUT BOX
- 331N82CX** CON SCATOLA
WITH BOX



Doccetta cromata per monoforo lavello, a due funzioni.
Pull-out handshower for single-hole sink mixer, two functions.

- 331N83A** SENZA SCATOLA
WITHOUT BOX
- 331N83AX** CON SCATOLA
WITH BOX



Doccetta cromata per monoforo lavello, a due funzioni.
Pull-out handshower for single-hole sink mixer, two functions.

- 331N83B** SENZA SCATOLA
WITHOUT BOX
- 331N83BX** CON SCATOLA
WITH BOX



Doccetta cromata per lavello monoforo, 2 funzione con pulsante di azionamento.
Pull-out handshower for single-hole sink mixer, 2 functions with on off botton.

- 331QK73** SENZA SCATOLA
WITHOUT BOX
- 331QK73X** CON SCATOLA
WITH BOX



Doccetta cromata per lavello monoforo, 2 funzioni.
Pull-out handshower for single-hole sink mixer, 2 functions.

- 331N85** SENZA SCATOLA
WITHOUT BOX
- 331N85X** CON SCATOLA
WITH BOX



Doccetta cromata per lavello monoforo, 2 funzioni.
Pull-out handshower for single-hole sink mixer, 2 functions.

- 331N86** SENZA SCATOLA
WITHOUT BOX
- 331N86X** CON SCATOLA
WITH BOX



Doccetta cromata per lavello monoforo, 2 funzioni.
Pull-out handshower for single-hole sink mixer, 2 functions.

- 331N87** SENZA SCATOLA
WITHOUT BOX
- 331N87X** CON SCATOLA
WITH BOX



Doccetta cromata per lavello monoforo, 1 funzione con pulsante di azionamento.
Pull-out handshower for single-hole sink mixer, 1 function with on off botton.

331V84 SENZA SCATOLA
WITHOUT BOX

331V84X CON SCATOLA
WITH BOX



Doccetta cromata per lavello monoforo, 2 funzioni.
Pull-out handshower for single-hole sink mixer, 2 functions.

331V84DJ SENZA SCATOLA
WITHOUT BOX

331V84DJX CON SCATOLA
WITH BOX



Doccetta cromata per lavello monoforo, 2 funzioni.
Pull-out handshower for single-hole sink mixer, 2 functions.

331V81M SENZA SCATOLA
WITHOUT BOX

331V81MX CON SCATOLA
WITH BOX



Doccetta cromata per lavello monoforo, 2 funzioni.
Pull-out handshower for single-hole sink mixer, 2 functions.

331DJN SENZA SCATOLA
WITHOUT BOX

331DJNX CON SCATOLA
WITH BOX



Doccetta cromata per lavello monoforo, 2 funzioni.
Pull-out handshower for single-hole sink mixer, 2 functions.

331DJC SENZA SCATOLA
WITHOUT BOX

331DJCX CON SCATOLA
WITH BOX



Doccetta cromata per lavello monoforo, 2 funzioni.
Pull-out handshower for single-hole sink mixer, 2 functions.

331DJD SENZA SCATOLA
WITHOUT BOX

331DJDJX CON SCATOLA
WITH BOX



Doccetta cromata per lavello monoforo, 1 funzione con pulsante di azionamento.
Pull-out handshower for single-hole sink mixer, 1 function with on off botton.

331N78 SENZA SCATOLA
WITHOUT BOX

331N78X CON SCATOLA
WITH BOX

LEGENDA ICONE - *ICONS LEGEND*



Acciaio INOX
Stainless Steel



Perfect Tune: Prodotto diponibile in più varianti.
Perfect Tune: Product available in different variants.

RUBINETTERIA - FAUCETS



Con scarico
With pop-up waste



Con scarico in plastica
With plastic waste



Con Click-Clack
With Click-Clak



Con Click-Clack con Troppo Pieno
With Click-Clak with Overflow



Senza Scarico
Without Waste



Eco
Eco



Cartuccia Energy Saving
Energy Saving Cartridge



Limitatore di Temperatura
Antiscalding



Risparmio Idrico Dinamico
Water Saving Dynamic



Risparmio Idrico
Water Saving



Risparmio Energetico
Energy Saving



Risparmio Idrico e Energetico
Water and Energy Saving

CUCINA - KITCHEN



Bocca Girevole
Swivel Spout



Corpo girevole
Swivel body



Doccetta Orientabile
Adjustable handshower



Doccetta Estraibile
Pull-Out Handshower



Bocca Abbattibile
Folding Spout



Doccetta a due funzioni
Two functions hand shower.



Acqua Frizzante
Sparkling Water



Acqua Potabile
Drinking Water

TECNOLOGIA - TECHNOLOGY



Touch-Me
Touch-Me



Tempor Touch
Tempor Touch



Con Luce Led
Whit Led Light



Con Batterie Alcaline Include
With Alkaline Batteries included



Alimentazione Elettrica
Power Supply



Azionamento a Sensore
Sensor Control



Con Temporizzazione per Lavatrice/Lavastoviglie
With Timing for washing/machine and Dish/Washer



Con filtro incluso
With filter included



Con Batterie al Litio Include
With Lithium Batteries included



Termostatico
Thermostatic

SOFFIONI - SHOWER HEADS



Getto effetto pioggia ad ampia copertura
Wide coverage rain effect



Getto effetto pioggia a risparmio idrico
Water-saving rain effect jet



Con Multigetto
With Multi Jet



Con Getto a Cascata
With Waterfall Jet



Getto Nebulizzato
Nebulized Jet



Cromoterapia
Colortherapy



Autopulente
Self-Cleaning



Con Getti Anticalcare
With Antilimestone Jets

KIT DOCCIA - SHOWER KIT



2 Vie
2 Ways



3 Vie
3 Ways



4 Vie
4 Ways



5 Vie
5 Ways



Flessibile Lungo 120 cm
Flexible Length 120 cm



Flessibile Lungo 150 cm
Flexible Length 150 cm



Flessibile Lungo 200 cm
Flexible Length 200 cm

DOCCHETTE - HANDSHOWERS



Posizione d'interruzione getto
Stop flow position



Getto intenso esterno con getto effetto pioggia interno
Intense external jet with internal rain effect jet



Getto intenso a risparmio idrico
Intense water-saving jet



Massaggio vigoroso ampia copertura effetto pioggia
Vigorous massage wide coverage rain jet



Getto vigoroso concentrato e getto esterno
Concentrated vigorous jet and external jet



Getto vigoroso concentrato
Vigorous concentrated jet



Getto Aerato Intenso
Intense Aerated Jet



Getto vigoroso effetto pioggia
Vigorous rain effect jet



Getto Vigoroso ed Ampio
Vigorous and Wide Jet



Getto spray ampia copertura e getto intenso esterno a risparmio idrico
Wide coverage spray jet and intense water saving external jet



Getto soft aerato mischiato ad un getto vigoroso a risparmio idrico
Soft aerated jet mixed with a vigorous water-saving jet



Pioggia soft a risparmio idrico
Soft rain water saving



Getto Esterno
External Jet



Con Getti Anticalcare
With Antilimestone Jets

COLONNE DOCCIA - SHOWER COLUMNS



Colonna Doccia Girevole
Swivable shower column



Colonna Doccia Telescopica
Telescopic shower column

REMER
RUBINETTERIE

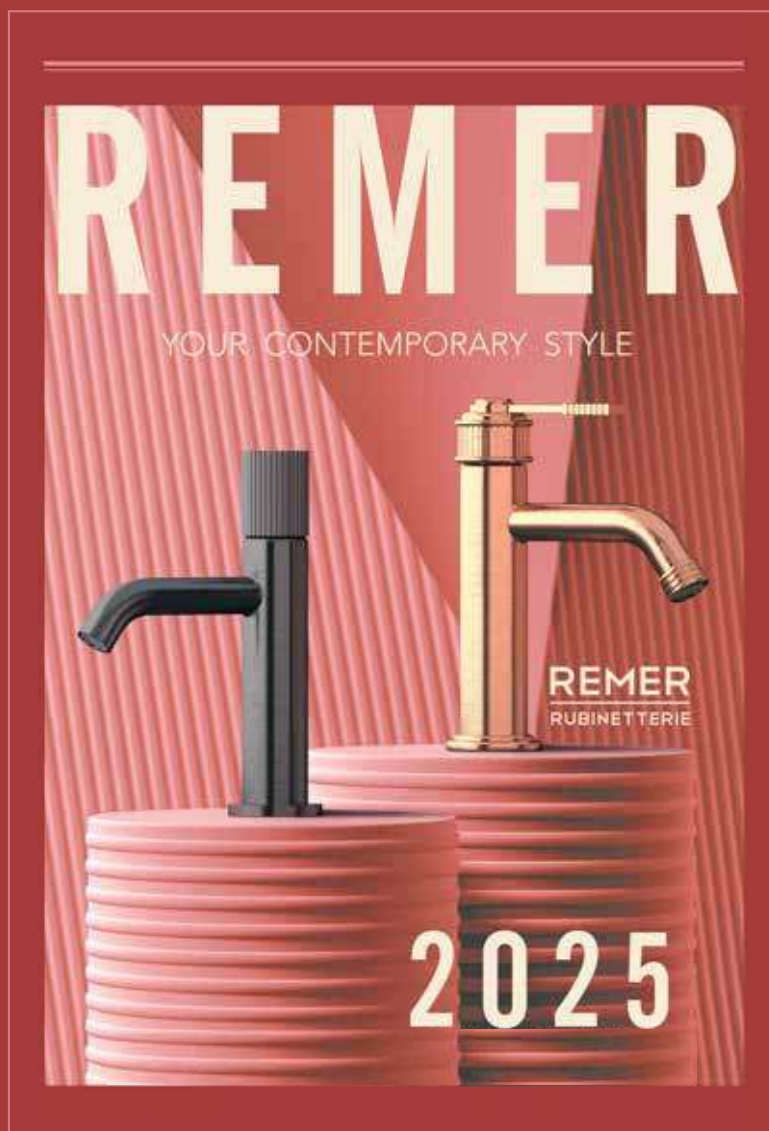

REMER RUBINETTERIE S.P.A.

Via Leonardo da Vinci, 83
20062 Cassano d'Adda
(MI) Italy
Tel. +39 0363 364 330

info@remer.eu
www.remer.eu

UFFICIO COMMERCIALE ITALIA:

Tel. 0363 364 333
Fax 0363 63 575

EXPORT COMMERCIAL DEPARTMENT:

Tel. +39 0363 364 364
Fax +39 0363 364 300