

REMER



INFINITY
COLLECTION

INFINITY

ARMONIA PER UNO STILE RAFFINATO
HARMONY FOR EXQUISITE STYLE

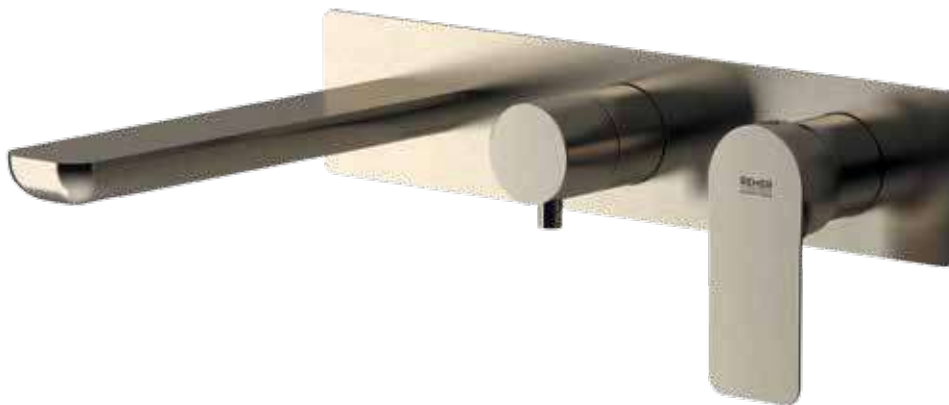

Infinity nasce da un'idea di design in cui la resa estetica di leggerezza del prodotto ricopre un ruolo di primaria importanza. La morbidezza del corpo ed i suoi raggi addolciti sono interrotti in corrispondenza della bocca di erogazione e della leva, entrambe caratterizzate dallo stesso profilo, estremamente assottigliate e con una superficie superiore completamente piana. La serie è dotata di cartuccia a dischi ceramici Ø 35 mm.

Infinity was born from an idea of design in which a role of primary importance is given to the final impact of lightness that the whole line gives. The smoothness of the body and its wide rays are interrupted in correspondance of the spout and the lever which suddenly show a completely flat upper surface. The series is equipped with a Ø 35 mm ceramic disc cartridge.







INFINITY



I11LNP



I15PLXV

//////////////////// OPZIONI DI FINITURA - FINISHING OPTIONS //////////////////////

CR		FIN 1		FIN 2	
	cromo chrome		nero opaco matt black		oro spazzolato brushed gold
	CR		bianco opaco matt white		oro lucido shiny gold
			visual inox visual steel		
			NO		BG
			BO		DO
			XV		

MISCELATORI LAVABO - WASHBASIN MIXERS



I10
Miscelatore monocomando lavabo, con scarico.
Single-lever basin mixer, with pop-up waste.



I10L
Miscelatore monocomando lavabo, con scarico click-clack con troppo-pieno.
Single-lever basin mixer, with click-clack waste and overflow.

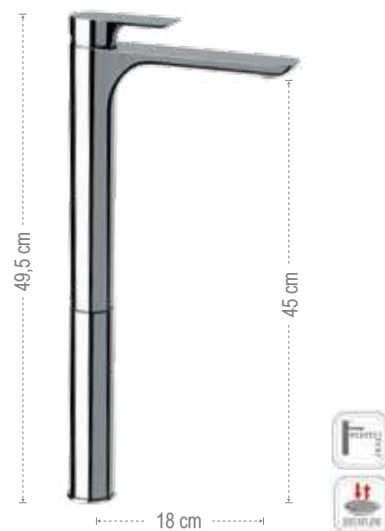

I10LXXL
Miscelatore monocomando lavabo alto XXL, con scarico click-clack con troppo-pieno.
XXL high single-lever basin mixer, with click-clack waste and overflow.



I11
Miscelatore monocomando lavabo, senza scarico.
Single-lever basin, mixer without waste.

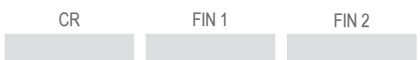

I11L
Miscelatore monocomando lavabo, senza scarico.
Single-lever basin mixer, without waste.

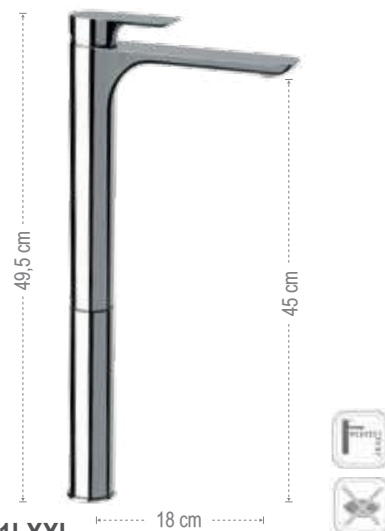

I11LXXL
Miscelatore monocomando lavabo alto XXL, senza scarico.
XXL high single-lever basin mixer, without waste.



I12
Miscelatore monocomando lavabo, senza scarico e senza foro sul corpo.
Single-lever basin mixer, without waste and without body hole.





I15
 Miscelatore monocomando a incasso per lavabo, con piastra in ottone.
Single-lever built-in basin mixer, with wall plate in brass.

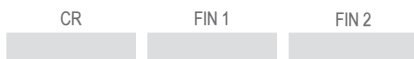

I15L
 Miscelatore monocomando a incasso per lavabo, con piastra in ottone. Lunghezza bocca 23 cm.
Single-lever built-in basin mixer, with wall plate in brass. Length spout 23 cm.

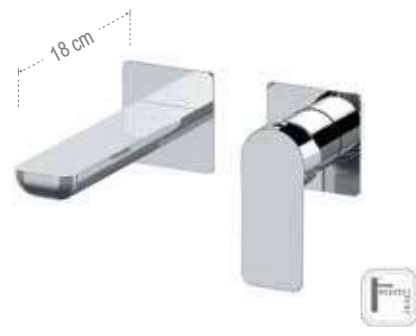

I15P
 Miscelatore monocomando a incasso per lavabo, su due piastre quadre separate.
Built-in single-lever basin mixer on two separate square plates.



I15PL
 Miscelatore monocomando a incasso per lavabo, su due piastre quadre separate. Lunghezza bocca 23 cm.
Built-in single-lever basin mixer on two separate square plates. Length spout 23 cm.

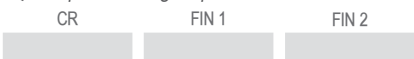

I72C
 Miscelatore monocomando lavabo, con canna corta girevole, tipo lusso.
Single-lever basin mixer without waste, with short swivel spout, luxury type.



I72
 Miscelatore monocomando monoforo 90°, con canna alta a "U" girevole.
Single-lever sink mixer 90°, high "U" swivel spout.

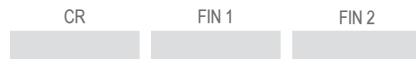

I57
 Miscelatore monocomando lavabo due fori senza scarico.
Two holes single-lever washbasin mixer without waste.



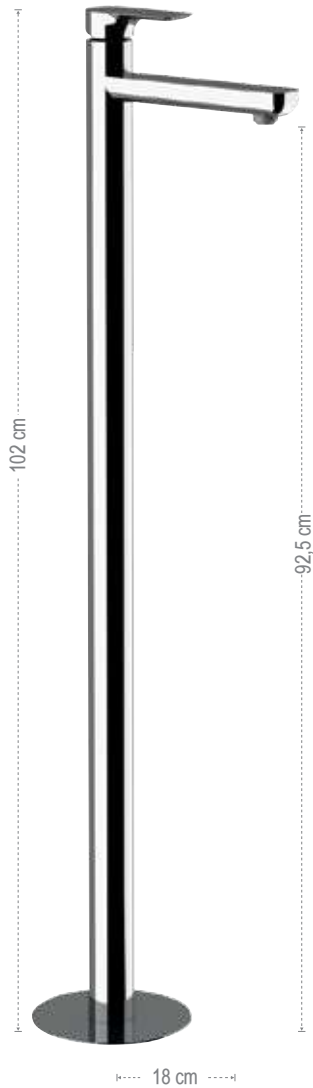

I18
 Miscelatore monocomando lavabo da terra con scarico click-clack con troppo-pieno. Prodotto completo.
Single-lever mixer for floor mounting with click-clack waste with overflow. Complete product.

CR FIN 1 FIN 2

Q08FIS2
 Solo parte interna.
Built-in components only.

CR

I18E
 Solo parti esterne.
Exposed components only.

CR FIN 1 FIN 2

BOCCE - SPOUTS

911
 Bocca incasso.
Built-in spout.

CR FIN 1 FIN 2

911L
 Lunghezza bocca 23cm.
Spout length 23cm.

CR FIN 1 FIN 2

LAVABO A MURO CON BOX INCASSO - WALL WASHBASIN MIXER WITH BUILT-IN BOX



SOLO PARTE ESTERNA - EXPOSED COMPONENTS ONLY:

I15WB
 Parti esterne per miscelatore monocomando a incasso per lavabo da abbinare al box incasso (non incluso). Piastra ultra-piatta. Lunghezza bocca 18 cm.
Exposed components for single-lever built-in basin mixer, with ultra-flat wall plate. To match with the built-in box (not included). Spout length 18 cm.

CR FIN 1 FIN 2

I15LWB
 Idem sopra, con lunghezza bocca 23 cm.
Same as above, with spout length 23 cm.

CR FIN 1 FIN 2

SOLO PARTE ESTERNA - EXPOSED COMPONENTS ONLY:

I15PWB
 Parti esterne per miscelatore monocomando a incasso per lavabo da abbinare al box incasso (non incluso). Su due piastre quadrate separate. Lunghezza bocca 18 cm.
Exposed components for single-lever built-in basin mixer, with two separate square plates. To match with the built-in box (not included). Spout length 18 cm.

CR FIN 1 FIN 2

I15PLWB
 Idem sopra, con lunghezza bocca 23 cm.
Same as above, with spout length 23 cm.

CR FIN 1 FIN 2

SOLO PARTE INTERNA - BUILT-IN COMPONENTS ONLY:

WBOX15

SOLO PARTE INTERNA - BUILT-IN COMPONENTS ONLY:

WBOX15

MISCELATORI BIDET - BIDET MIXERS



I20
Monocomando bidet, con scarico.
Single-lever bidet mixer, with pop-up waste.



I21
Monocomando bidet, senza scarico.
Single-lever bidet mixer, without pop-up waste.

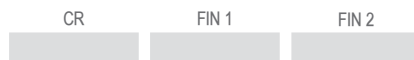

I22
Miscelatore monocomando bidet senza scarico e senza foro sul corpo.
Single-lever bidet mixer without waste and without body hole.



I60W
Miscelatore incasso shut-off coprensivo di: doccetta shut-off, supporto doccia-presa acqua, tutto in ottone e flessibile cm 120.
Built-in shower mixer set including: shut-off, shower holder water punch, all in brass and flexible hose cm 120



IC31REW
Miscelatore monocomando esterno doccia, interasse 10 cm per shut-off, con doccetta a pulsante, flessibile 120 cm e supporto in ottone.
Shut-off wall mounted single lever shower mixer, interaxis 10 cm, with shut-off handshower, flexible hose cm 120 and brass shower older.

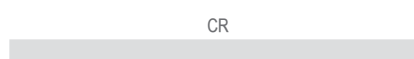

I65W
Miscelatore incasso per shut-off con supporto doccia/presa acqua integrato, attacco conico da 1/2", tutto in ottone, con doccetta shut-off e flessibile cm 120.
Built-in shower mixer with integrated shower holder/water punch on flange all in brass, with 1/2 connection, including shut-off and flexible hose cm 120.



IC31
Miscelatore monocomando esterno doccia, interasse 10 cm per shut-off, senza kit doccia.
Shut-off wall mounted single lever shower mixer, interaxis 10 cm, without shower kit.



I65B
Miscelatore incasso per shut-off con supporto doccia/presa acqua integrato, attacco conico da 1/2", tutto in ottone, senza kit doccia.
Built-in shower mixer with integrated shower holder/water punch on flange all in brass, with 1/2 connection, without shower kit.



MISCELATORI ESTERNI PER VASCA E DOCCIA - EXPOSED MIXERS FOR BATH AND SHOWER



I02

Miscelatore vasca, con flessibile cm 150 e doccetta ovale ad 1 funzione con getti anticalcare.
Wall mounted bath mixer, with flexible hose cm 150 and 1 function antilimestone oval handshower.

CR



I49

Miscelatore lavabo/vasca con canna fusa lunga 30 cm e deviatore, con flessibile cm 150 e doccetta ovale ad 1 funzione con getti anticalcare.
Wall basin/bath single lever mixer with cm 30 long casted spout with diverter, with flexible hose cm 150 and 1 function antilimestone oval handshower.

CR



IR38

Miscelatore doccia con leva frontale, con flessibile cm 150 e doccetta ovale ad 1 funzione con getti in anticalcare.
Wall mounted shower mixer with frontal lever, with flexible hose cm 150 and 1 function antilimestone oval handshower.

CR



I05

Miscelatore vasca, senza kit doccia.
Wall mounted bath mixer, without shower kit.

CR

FIN 1

FIN 2



I46

Miscelatore lavabo/vasca con canna fusa lunga 30 cm e deviatore, senza kit doccia.
Wall basin/bath single lever mixer without shower kit.

CR

FIN 1

FIN 2



IR33

Miscelatore doccia con leva frontale, senza kit doccia.
Wall mounted shower mixer with frontal lever, without shower kit.

CR

FIN 1

FIN 2



I39

Miscelatore doccia, con flessibile cm 150 e doccetta ovale ad 1 funzione con getti anticalcare.
Wall mounted, with flexible hose cm 150 and 1 function antilimestone oval handshower.

CR



I31

Miscelatore doccia, senza kit doccia.
Wall mounted, without shower kit.

CR

FIN 1

FIN 2

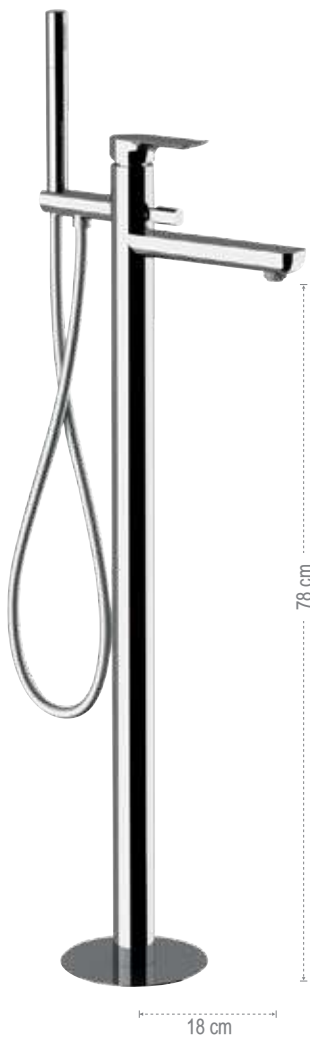

I08

Miscelatore bordo vasca da pavimento, con deviatore e doccetta ad 1 funzione e flessibile 150 cm in ottone. Prodotto completo.

Single-lever bath mixer floor mounting, with diverter and brass 1 function handshower and flexible hose 150 cm. Complete product.



CR FIN 1 FIN 2

Q08FIS2

Solo parte interna.

Built-in components only.



CR

I08E

Solo parti esterne.

Exposed components only.

CR FIN 1 FIN 2



I07

Miscelatore monocomando bordo vasca con deviatore a leva integrato nella bocca minimale e doccetta estraibile ad 1 funzione anticalcare.

Single lever deck bath mixer with with lever diverter integrated on the spout, with minimal spout and pull-out 1 function antilimestone handshower.

CR



I07UF

Miscelatore monocomando bordo vasca con deviatore integrato nel miscelatore, bocca a cascata e doccetta ad 1 funzione anticalcare.

Single lever deck bath mixer with diverter integrated on the mixer, with waterfall spout and antilimestone pull-out 1 function handshower.

CR



I27

Miscelatore bordo vasca con deviatore integrato nel miscelatore e doccetta anticalcare ad 1 funzione estraibile.

Single lever bath deck mixer with diverter integrated on the mixer and pull-out 1 function antilimestone handshower.

CR



SOLO PARTE ESTERNA - EXPOSED COMPONENTS ONLY:

I53D2WB

Set a incasso a 2 vie per vasca su piastra unica rettangolare.
2-way built-in set for bathtub on a single rectangular plate

CR FIN 1 FIN 2



SOLO PARTE INTERNA - BUILT-IN COMPONENTS ONLY:

WBOX97D2

> pag 304



SOLO PARTE ESTERNA - EXPOSED COMPONENTS ONLY:

I53D2PWB

Set a incasso a 2 vie per vasca su piastre quadrate separate.
2-way built-in set for bathtub on separate square plates

CR FIN 1 FIN 2



SOLO PARTE INTERNA - BUILT-IN COMPONENTS ONLY:

WBOX97D2

> pag 304



SOLO PARTE ESTERNA - EXPOSED COMPONENTS ONLY:

I54D2WB

Set miscelatore a incasso a 2 vie per vasca/doccia su piastra unica rettangolare. Da completare con la seconda uscita.
2-way built-in mixer set for bathtub / shower on single rectangular plate. To be completed with the second water outlet.

CR FIN 1 FIN 2

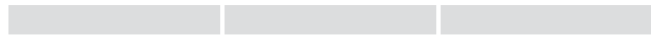

SOLO PARTE INTERNA - BUILT-IN COMPONENTS ONLY:

WBOX97D2

> pag 304



SOLO PARTE ESTERNA - EXPOSED COMPONENTS ONLY:

I54D2PWB

Set miscelatore a incasso a 2 vie per vasca/doccia su 3 piastre quadrate. Da completare con la seconda uscita acqua.
2-way built-in mixer set for bathtub / shower on 3 square plates. To be completed with the second water outlet.

CR FIN 1 FIN 2

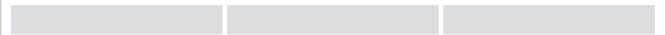

SOLO PARTE INTERNA - BUILT-IN COMPONENTS ONLY:

WBOX97D2

> pag 304

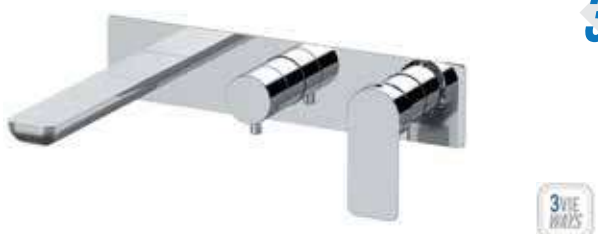

SOLO PARTE ESTERNA - EXPOSED COMPONENTS ONLY:

I54D3WB

Set miscelatore a incasso a 3 vie per vasca/doccia su piastra unica rettangolare. Da completare con la seconda e la terza uscita acqua.
3-way built-in mixer set for bathtub / shower on single rectangular plate. To be completed with the second and the third water outlet.

CR FIN 1 FIN 2

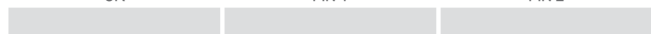

SOLO PARTE INTERNA - BUILT-IN COMPONENTS ONLY:

WBOX97D3

> pag 308

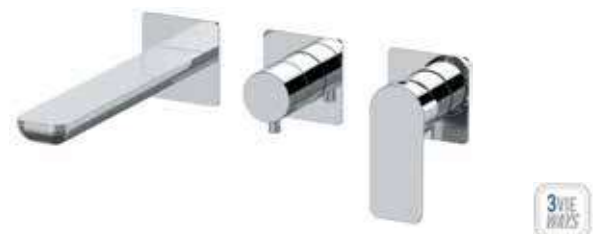

SOLO PARTE ESTERNA - EXPOSED COMPONENTS ONLY:

I54D3PWB

Set miscelatore a incasso a 3 vie per vasca/doccia su 3 piastre quadrate. Da completare con la seconda e la terza uscita acqua.
3-way built-in mixer set for bathtub / shower on 3 separate square plates. To be completed with the second and the third water outlet.

CR FIN 1 FIN 2

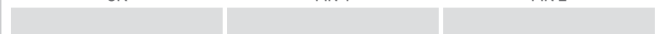

SOLO PARTE INTERNA - BUILT-IN COMPONENTS ONLY:

WBOX97D3

> pag 308



I30
Miscelatore monocomando a incasso per doccia completo.
Complete single lever built-in shower mixer.



I09
Miscelatore monocomando a incasso con deviatore per vasca/doccia completo.
Complete single lever built-in bath/shower mixer with diverter.



N09B
Solo parte interna.
Built-in components only.



I09E
Solo parte esterna.
Exposed components only.



I09HL
Miscelatore a incasso per vasca/doccia con deviatore a 2 vie a vitone ceramico. Per selezionare l'uscita desiderata, la manopola del deviatore deve essere ruotata da una posizione all'altra.
Built-in bath/shower mixer with 2-way diverter with ceramic head valve. To select the desired output, the diverter knob must be turned from one position to the other.



I09HRG
Miscelatore a incasso per vasca/doccia con deviatore a 2 vie con vitone ceramico, su piastra rettangolare, montaggio orizzontale. Per selezionare l'uscita desiderata, la manopola del deviatore deve essere ruotata da una posizione all'altra.
Built-in bath/shower mixer with 2-way diverter with ceramic head valve, on rectangular plate, horizontal mounting. To select the desired output, the diverter knob must be turned from one position to the other.



N09HB
Solo parte interna.
Built-in components only.



I09E
Solo parte esterna.
Exposed components only.



N09HRB
Solo parte interna.
Built-in components only.



I09GE
Solo parte esterna.
Exposed components only.





SOLO PARTE ESTERNA - EXPOSED COMPONENTS ONLY:

I92ZWB

Miscelatore a incasso per vasca/doccia con deviatore a 2 vie di tipo meccanico, su piastra rettangolare.
Built-in bath/shower mixer with 2-way mechanical diverter, on rectangular plate.

CR FIN 1 FIN 2

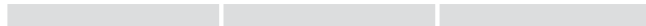

SOLO PARTE INTERNA - BUILT-IN COMPONENTS ONLY:

WBOX92Z

pag 300



SOLO PARTE ESTERNA - EXPOSED COMPONENTS ONLY:

I92ZPWB

Miscelatore a incasso per vasca/doccia con deviatore a 2 vie di tipo meccanico, su due piastre quadrate.
Built-in bath/shower mixer with 2-way mechanical diverter, on two square plates.

CR FIN 1 FIN 2

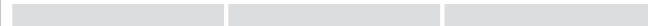

SOLO PARTE INTERNA - BUILT-IN COMPONENTS ONLY:

WBOX92Z

pag 300



SOLO PARTE ESTERNA - EXPOSED COMPONENTS ONLY:

I97D2PWB

Set miscelatore a incasso a 2 vie per vasca/doccia su 3 piastre quadrate. Da completare con la seconda e la terza uscita acqua.
2-way built-in bath/shower mixer set on 3 square plates. To be completed with the second and the third water outlet.

CR FIN 1 FIN 2

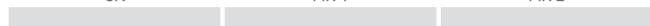

SOLO PARTE INTERNA - BUILT-IN COMPONENTS ONLY:

WBOX97D2

pag 304



SOLO PARTE ESTERNA - EXPOSED COMPONENTS ONLY:

I97D2WB

Set miscelatore a incasso a 2 vie per vasca/doccia su piastra rettangolare. Da completare con la seconda e la terza uscita acqua.
2-way built-in shower mixer set on rectangular plate. To be completed with the second and the third water outlet.

CR FIN 1 FIN 2



SOLO PARTE INTERNA - BUILT-IN COMPONENTS ONLY:

WBOX97D2

pag 304

2 VIE
WAYS



2 VIE
WAYS

I92

Miscelatore monocomando a incasso per doccia, con deviatore a due posizioni (due uscite ed una entrata) su piastra unica.
Single-lever built-in shower mixer with 2 positions diverter (2 outlets and 1 inlet) on single plate.

CR

FIN 1

FIN 2

3 VIE
WAYS



3 VIE
WAYS

I93

Miscelatore monocomando per doccia con deviatore a 3 posizioni (3 uscite ed 1 entrata) su piastra unica
Single-lever shower mixer with 3-positions diverter (3 outlets and 1 inlet) on single plate

CR

FIN 1

FIN 2

3 VIE
WAYS



3 VIE
WAYS

SOLO PARTE ESTERNA - EXPOSED COMPONENTS ONLY:

I93ZWB

Miscelatore a incasso per vasca/doccia con deviatore a 3 vie di tipo meccanico, su piastra rettangolare.
Built-in bath/shower mixer with 3-way mechanical diverter, on rectangular plate.

CR

FIN 1

FIN 2



3 VIE
WAYS

SOLO PARTE ESTERNA - EXPOSED COMPONENTS ONLY:

I93ZPWB

Miscelatore a incasso per vasca/doccia con deviatore a 3 vie di tipo meccanico, su due piastre quadrate.
Built-in bath/shower mixer with 3-way mechanical diverter, on two square plates.

CR

FIN 1

FIN 2

SOLO PARTE INTERNA - BUILT-IN COMPONENTS ONLY:

WBOX93Z

pag 302

SOLO PARTE INTERNA - BUILT-IN COMPONENTS ONLY:

WBOX93Z

pag 302



3 VIE
WAYS



SOLO PARTE ESTERNA - EXPOSED COMPONENTS ONLY:

I97D3PWB

Set miscelatore a incasso a 3 vie per vasca/doccia su 3 piastre quadrate. Da completare con la seconda e la terza uscita acqua.
3-way built-in bath/shower mixer set on 3 square plates. To be completed with the second and the third water outlet.

CR

FIN 1

FIN 2



SOLO PARTE ESTERNA - EXPOSED COMPONENTS ONLY:

I97D3WB

Set miscelatore a incasso a 3 vie per vasca/doccia su piastra rettangolare. Da completare con la seconda e la terza uscita acqua.
3-way built-in shower mixer set on rectangular plate. To be completed with the second and the third water outlet.

CR

FIN 1

FIN 2



SOLO PARTE INTERNA - BUILT-IN COMPONENTS ONLY:

WBOX97D3

pag 308

SOLO PARTE INTERNA - BUILT-IN COMPONENTS ONLY:

WBOX97D3

pag 308

4/5 VIE
WAYS



I94

Miscelatore monocomando per doccia, con deviatore a 4 posizioni (4 uscite ed 1 entrata) su piastra unica.
Single-lever shower mixer with 4 positions diverter (4 outlets and 1 inlet) on single plate.

CR

FIN 1

FIN 2

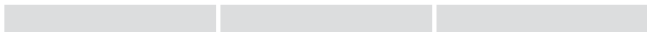

I95

Miscelatore monocomando per doccia, con deviatore a 5 posizioni (5 uscite ed una entrata) su piastra unica.
Single-lever shower mixer with 5 positions diverter (5 outlets and 1 inlet) on single plate.

CR

FIN 1

FIN 2

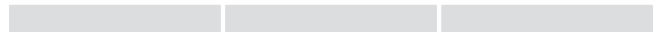

SALISCENDI E COLONNE DOCCIA - SLIDING RAILS AND SHOWER COLUMNS

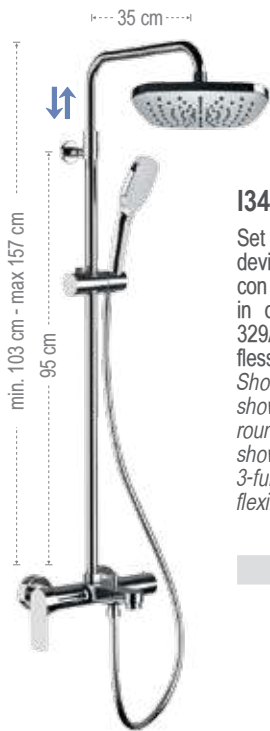

I34A8CPAD20

Set doccia composto da: miscelatore esterno con deviatore vasca/doccia, soffione in abs 20x20cm con angoli arrotondati 356AD20X, colonna doccia in ottone telescopica, altezza asta regolabile 329A, doccetta in abs con 3 funzioni 318CP, flessibile 150 cm.

Shower set including: exposed mixer with bath/shower diverter, abs 20x20 cm shower head with rounded corners 356AD20X, telescopic brass shower column, with height-adjustable rod 329A, 3-function abs hand shower 318CP, 150 cm flexible hose.

CR

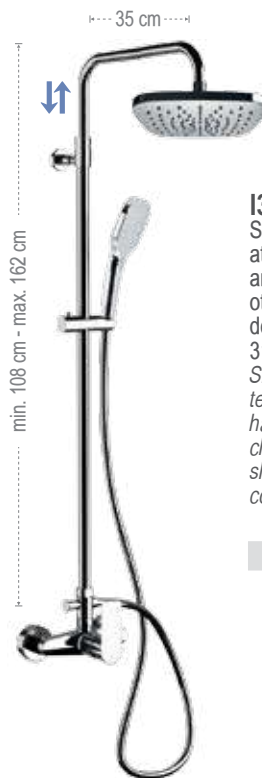

I37A8CPAD20

Set doccia composto da: miscelatore esterno con attacco superiore, soffione in abs 20x20cm con angoli arrotondati 356AD20X, colonna doccia in ottone telescopica, altezza asta regolabile, con deviatore 330A, doccetta in abs con 3 funzioni 318CP, flessibile 150 cm.

Shower mixer with 3/4" upper connection, telescopic shower column with diverter, ABS handshower 3 functions antilimestone (button to change the jets), 150 cm flexible hose and ABS shower head 20x20 cm, squared with rounded corners, with antilimestone silicon jets.

CR



317V317RV

Saliscendi cromato con asta minimale ovale dritta, flessibile in ottone 150 cm e doccetta ovale ad 1 funzione con getti anticalcare.

Sliding rail set with minimal oval rod, brass flexible hose 150 cm and 1 function antilimestone oval handshower.

CR



LEGENDA ICONE - *ICONS LEGEND*



Acciaio INOX
Stainless Steel



Perfect Tune: Prodotto diponibile in più varianti.
Perfect Tune: Product available in different variants.

RUBINETTERIA - FAUCETS



Con scarico
With pop-up waste



Con scarico in plastica
With plastic waste



Con Click-Clack
With Click-Clak



Con Click-Clack con Troppo Pieno
With Click-Clak with Overflow



Senza Scarico
Without Waste



Eco
Eco



Cartuccia Energy Saving
Energy Saving Cartridge



Limitatore di Temperatura
Antiscalding



Risparmio Idrico Dinamico
Water Saving Dynamic



Risparmio Idrico
Water Saving



Risparmio Energetico
Energy Saving



Risparmio Idrico e Energetico
Water and Energy Saving

CUCINA - KITCHEN



Bocca Girevole
Swivel Spout



Corpo girevole
Swivel body



Doccetta Orientabile
Adjustable handshower



Doccetta Estraibile
Pull-Out Handshower



Bocca Abbattibile
Folding Spout



Doccetta a due funzioni
Two functions hand shower.



Acqua Frizzante
Sparkling Water



Acqua Potabile
Drinking Water

TECNOLOGIA - TECHNOLOGY



Touch-Me
Touch-Me



Tempor Touch
Tempor Touch



Con Luce Led
Whit Led Light



Con Batterie Alcaline Include
With Alkaline Batteries included



Alimentazione Elettrica
Power Supply



Azionamento a Sensore
Sensor Control



Con Temporizzazione per Lavatrice/Lavastoviglie
With Timing for washing/machine and Dish/Washer



Con filtro incluso
With filter included



Con Batterie al Litio Include
With Lithium Batteries included



Termostatico
Thermostatic

SOFFIONI - SHOWER HEADS



Getto effetto pioggia ad ampia copertura
Wide coverage rain effect



Getto effetto pioggia a risparmio idrico
Water-saving rain effect jet



Con Multigetto
With Multi Jet



Con Getto a Cascata
With Waterfall Jet



Getto Nebulizzato
Nebulized Jet



Cromoterapia
Colortherapy



Autopulente
Self-Cleaning



Con Getti Anticalcare
With Antilimestone Jets

DOCCHETTE - HANDSHOWERS



Posizione d'interruzione getto
Stop flow position



Getto intenso esterno con getto effetto pioggia interno
Intense external jet with internal rain effect jet



Getto intenso a risparmio idrico
Intense water-saving jet



Massaggio vigoroso ampia copertura effetto pioggia
Vigorous massage wide coverage rain jet



Getto vigoroso concentrato e getto esterno
Concentrated vigorous jet and external jet



Getto vigoroso concentrato
Vigorous concentrated jet



Getto Aerato Intenso
Intense Aerated Jet



Getto vigoroso effetto pioggia
Vigorous rain effect jet



Getto Vigoroso ed Ampio
Vigorous and Wide Jet



Getto spray ampia copertura e getto intenso esterno a risparmio idrico
Wide coverage spray jet and intense water saving external jet



Getto soft aerato mischiato ad un getto vigoroso a risparmio idrico
Soft aerated jet mixed with a vigorous water-saving jet



Pioggia soft a risparmio idrico
Soft rain water saving



Getto Esterno
External Jet



Con Getti Anticalcare
With Antilimestone Jets

KIT DOCCIA - SHOWER KIT



2 Vie
2 Ways



3 Vie
3 Ways



4 Vie
4 Ways



5 Vie
5 Ways



Flessibile Lungo 120 cm
Flexible Length 120 cm



Flessibile Lungo 150 cm
Flexible Length 150 cm



Flessibile Lungo 200 cm
Flexible Length 200 cm

COLONNE DOCCIA - SHOWER COLUMNS



Colonna Doccia Girevole
Swivable shower column



Colonna Doccia Telescopica
Telescopic shower column

REMER
RUBINETTERIE

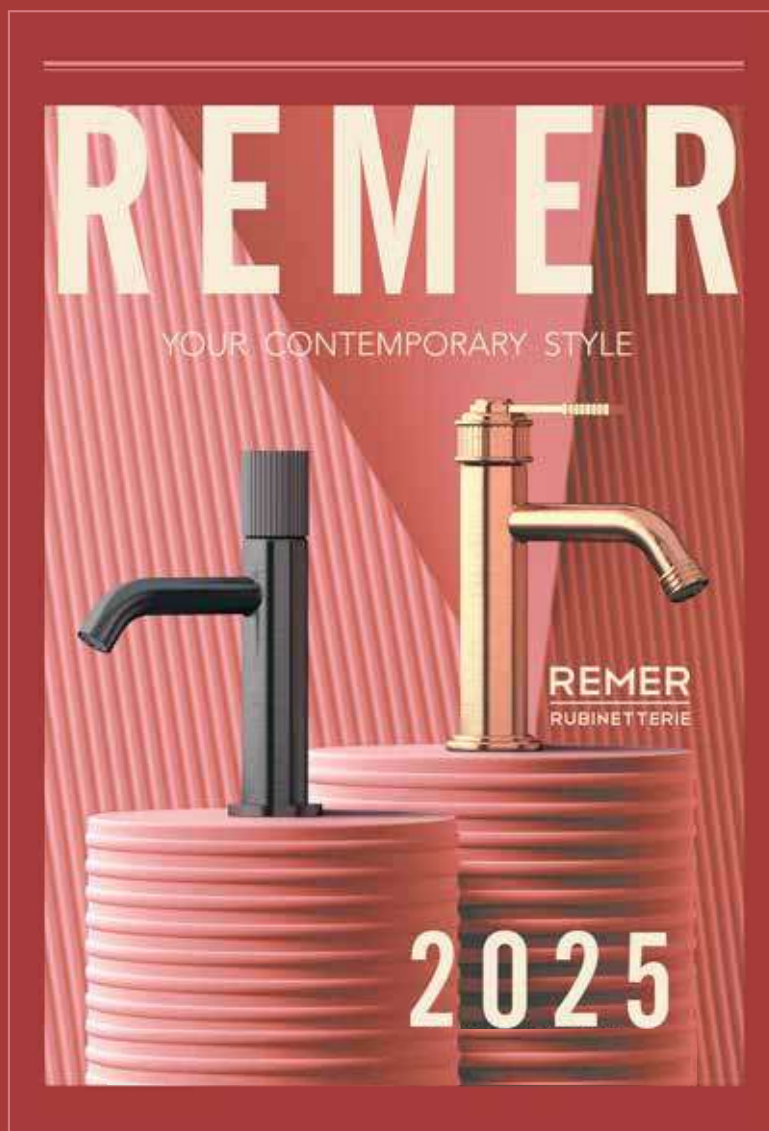

REMER RUBINETTERIE S.P.A.

Via Leonardo da Vinci, 83
20062 Cassano d'Adda
(MI) Italy
Tel. +39 0363 364 330

info@remer.eu
www.remer.eu

UFFICIO COMMERCIALE ITALIA:

Tel. 0363 364 333
Fax 0363 63 575

EXPORT COMMERCIAL DEPARTMENT:

Tel. +39 0363 364 364
Fax +39 0363 364 300